

GXS and GMD Booster sets series

BOOSTER SETS FOR RESIDENTIAL MARKET

HORIZONTAL MULTI-STAGE ELECTRIC PUMP e-HM SERIES

HORIZONTAL CENTRIFUGE ELECTRIC PUMP CEA SERIES

HORIZONTAL CENTRIFUGE ELECTRIC PUMP BG SERIES

VERTICAL MULTI-STAGE ELECTRIC PUMP e-SV SERIES

CLOSE-COUPLED THREADED VERTICAL MULTI-STAGE ELECTRIC PUMP VM SERIES

ErP 2009/125/EC

Directive 2009/125/EC of the European Union

The **Directive 2005/32/EC** on energy-using products (**EuP**) and the subsequent **Directive 2009/125/EC** on energy-related products (**ErP**) established the ecodesign requirements for products to reduce their energy consumption and consequently their environmental impact.

These requirements apply to products placed and used in the European Economic Area (European Union plus Iceland, Liechtenstein and Norway) as a stand-alone unit or as integrated parts in other products.

The table shows the Regulations that define the requirements for Lowara products:

- Some types of **pump**, used for pumping clean water:

Regulations	From	Target
(EU) N. 547/2012	1 January 2015	MEI ≥ 0,4

- **Circulators** with a rated hydraulic output power of between 1 and 2500 W, designed for use in heating systems or in secondary circuits of cooling distribution systems:

Regulations	From	Target
(EC) N. 641/2009, (EU) N. 622/2012 and (EU) 2019/1781	1 August 2015	EEL < 0,23

- **Three-phase motors** with frequency 50 or 60 or 50/60 Hz and voltages between 50 and 1000 V (S1 and D.O.L.):

Regulations	From	Target
(EU) 2019/1781 and 2021/341	1 July 2023	IE2 : motors with a rated output ≥ 0,12 and < 0,75 kW IE3 : motors with a rated output ≥ 0,75 and < 75 kW IE4 : motors with a rated output ≥ 75 and < 201 kW IE3 : motors with a rated output ≥ 201 and < 1000 kW

- **Single-phase motors** with frequency 50 or 60 or 50/60 Hz and voltages between 50 and 1000 V (S1 and D.O.L.):

Regulations	From	Target
(EU) 2019/1781 and 2021/341	1 July 2023	IE2 : motors with a rated output ≥ 0,12

- **Variable speed drives** with three-phase input and rated output power from 0,12 kW up to 1000 kW, rated for operating with motor included in the same regulations:

Regulations	From	Target
(EU) 2019/1781 and 2021/341	1 July 2021	IE2

Lowara, e-SV, Xylect, HYDROVAR, Optimize are trademarks of Xylem Inc. or one of its subsidiaries. All other trademarks of registered trademarks are property of their respective owners.

CONTENTS

GENERAL INTRODUCTION - PRODUCT DESCRIPTION	4
DESCRIPTION OF OPERATION	5
INSTALLATION	7
CHARACTERISTICS OF e-HM ELECTRIC PUMPS	13
CHARACTERISTICS OF CEA ELECTRIC PUMPS	21
CHARACTERISTICS OF BG ELECTRIC PUMPS.....	25
CHARACTERISTICS OF e-SV ELECTRIC PUMPS	28
CHARACTERISTICS OF VM ELECTRIC PUMPS	34
RANGE	38
GXS Series	39
IDENTIFICATION CODE	40
CONTROL PANEL	41
MAIN COMPONENTS	42
DIMENSIONAL TABLE.....	44
GMD Series	51
IDENTIFICATION CODE	52
CONTROL PANEL	53
MAIN COMPONENTS	54
DIMENSIONAL TABLE.....	56
PERFORMANCE CURVES	63
ACCESSORIES.....	107
OPTIMIZE™	113
TECHNICAL APPENDIX.....	115

BOOSTER SETS GX S AND GMD SERIES

GENERAL INTRODUCTION - PRODUCT DESCRIPTION

GXS and **GMD** booster sets are designed to transfer and increase the pressure of water, in the following applications:

- Public buildings
- Apartment
- Single house
- Condominiums
- Garden irrigation

The booster sets of the series described above are pumping stations assembled with two **e-HM** series horizontal multistage pumps, **CEA** or **BG** series horizontal centrifugal pumps, **e-SV** series vertical multistage pumps, **VM** series close-coupled vertical multistage pumps.

The **GXS** and **GMD** booster sets series are pumping station with single-phase or three-phase power supply depending on the type of set, with two fixed speed automatic pumps. The boosters sets have two pumps with automatic operating and fixed speed. The pumps are connected to one another by suction and delivery pipes, and fixed onto a single base. The pumps are connected to the manifolds by means of stop valves and check valves. An electric protection and control panel is installed using a bracket on the base of the set. There are available a different type of customized applications.

GXS and GMD series booster sets with e-HM, e-SV and VM series pumps are certified for use with drinking water according to WRAS and ACS standards, and with Italian Ministry Decree no. 174.

BOOSTER SETS GX S AND GMD SERIES

CHOICE AND SELECTION

The following conditions should be considered when choosing a booster set:

- The system's requirements should be met regarding flow rate and pressure.
- The booster set must not be oversized, avoiding unnecessary installation and running costs.

Generally speaking, the water consumption in water distribution systems, such as circuits for villas, detached houses and the like, is defined as "variable" though it is fairly concentrated during the day in what are known as peak consumption periods. Given the type of residential use, these concentrations of water demand mainly occur in the morning and in the evening.

The definition of the flow for these system types is generally based on practical tables giving the value of daily consumption depending on the type of user (number of occupants, number of services, etc..).

The size of the pressure booster set and, in practice, the performance levels of the pumps and the number of pumps is based on the take-off point and, therefore, on the consumption value which takes the following factors into account:

- The consumption peak
- Yield
- NPSH
- Diaphragm tanks

BOOSTER SETS GX5 AND GMD SERIES

DESCRIPTION OF OPERATION

GXS BOOSTER SERIES

The starting and stopping of the pumps are determined by the pressure values set and measured by the transducer control. The pressure values are set by the controller. In the case of sets with jockey pump, this will start first and stop last, in accordance with the set pressure values.

GMD BOOSTER SERIES

The starting and stopping of the pumps are determined by the pressure values set on the pressure switches. Each pressure switch is connected to a single pump with a cyclic pump changeover. The differential pressure is the difference between starting pressure and switch-off pressure. It is set at the same value for both pumps.

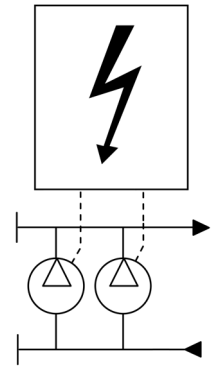

- On demand, the pressure decreases in the system until it reaches the pressure to start the first pump (P1start).
- If the water consumption increases, the pressure decreased and the second pump starts (P2start).
- When the water consumption decreases, the pressure in the system increases and the first pump stops at the P2 setting (P2stop).
- If the water consumption decrease yet, the second pump stops (P1stop).
- With the function "timer", the last pump functioning, will remain turned on, until will reach the maximum pressure.
- Before starting, check that the maximum pressure of the pumps must be compatible with the maximum pressure of the system.
- The below picture shows the operating mode with the pumps' curves:

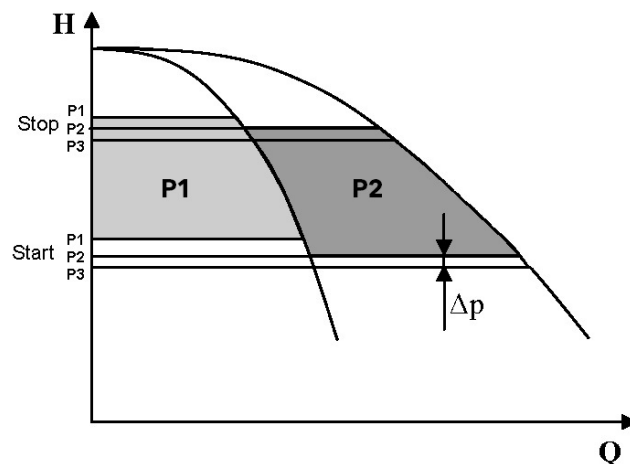

BOOSTER SETS GXS AND GMD SERIES

DESCRIPTION OF OPERATION

BOOSTER SERIES GXS

On fixed speed booster sets **GXS** series, the control and protection panel with electronic board, manages the operations of the pumps, the cyclic changeover, and, in case of lack of water on suction side, stops the set. The pumps run in cascade through the transmitter signal.

Cyclical exchange of pumps

In the **GXS** e **GMD** series, the cyclical exchange of pumps is controlled by electrical panel.

Maximum delivery pressure protection

The maximum delivery pressure function can be managed by entering the pressure value in the menu of the frequency converter, which will receive the signal through the pressure transducer at the delivery.

Minimum delivery pressure protection

The minimum delivery pressure function can be managed by entering the pressure value in the menu of the frequency converter, which will receive the signal through the pressure transducer at the delivery.

Tank

Frequent demand or small system losses determine pressure variations that may be compensated for by using a tank. Correct selection of a diaphragm tank reduces the number of pump starts and, if it is installed near the booster set, helps reduce the effect of water hammer.

The booster sets are ready for installation with diaphragm tanks mounted directly on the delivery manifold, and additional tanks can be connected to the unused end of the manifold.

BOOSTER SERIES GMD

On fixed speed booster sets **GMD** series, the control and protection panel with electronic board, manages the operations of the pumps, the cyclic changeover, and, in case of lack of water on suction side, stops the set. The pumps run in cascade through the two pressure switches signals.

Cyclical exchange of pumps

In the **GXS** e **GMD** series, the cyclical exchange of pumps is controlled by electrical panel.

Maximum delivery pressure protection

The maximum delivery pressure function can be managed by pressure switch (option /BAP)

Tank

Frequent demand or small system losses determine pressure variations that may be compensated for by using a tank. Correct selection of a diaphragm tank reduces the number of pump starts and, if it is installed near the booster set, helps reduce the effect of water hammer.

The booster sets are ready for installation with diaphragm tanks mounted directly on the delivery manifold, and additional tanks can be connected to the unused end of the manifold.

BOOSTER SETS GXS AND GMD SERIES INSTALLATION

The booster sets must be installed in areas protected against frost and with adequate ventilation to cool the motors.

It is a good practice to connect the booster set to the suction and delivery pipes of the system inserting vibration-damping joints to limit the transmission of vibrations and resonance to the system.

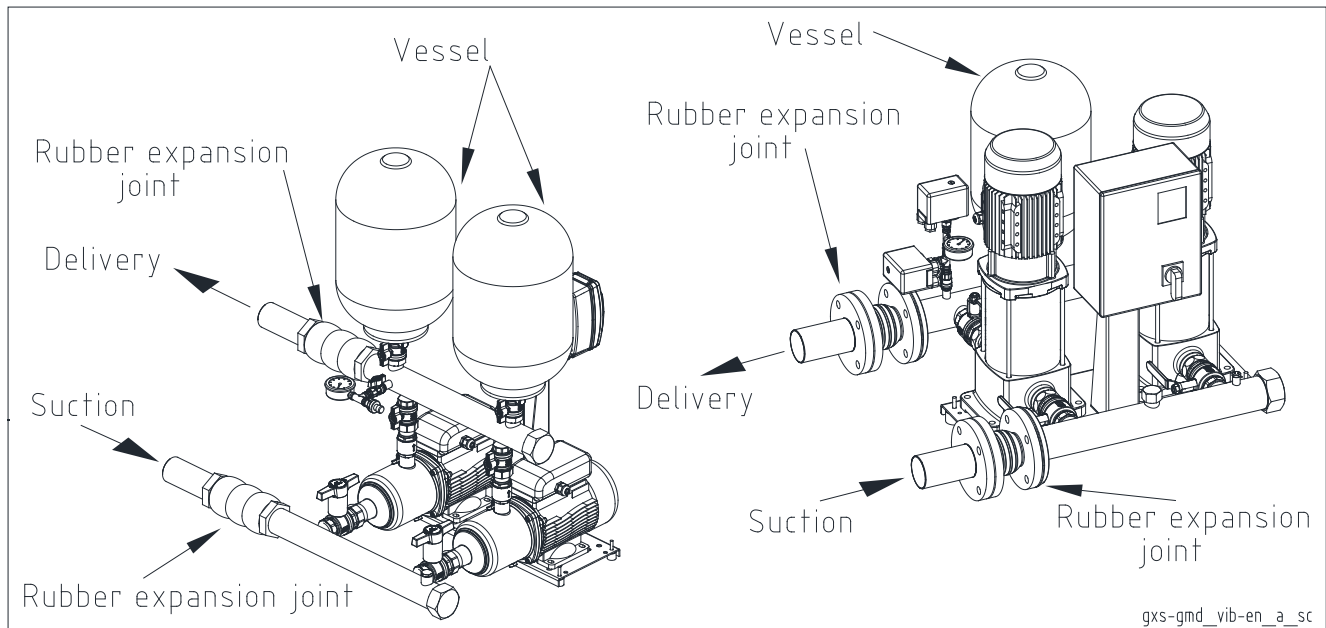

The booster sets must be connected to pressurized tanks with an adequate capacity for the system to be made. These tanks can avoid any problems due to water hammer that is created due to the sudden stopping of the electric pumps running. For this type of system, it is possible to install in the delivery piping diaphragm expansion vessels (hydro tube) that perform a pressure dampening function.

For the sizing of the expansion vessels, see the specific chapter in this catalogue.

Considering also that variable-pressure sets are very sensitive to swings of pressure in the system, the use of vessels allows the pressure to stabilize when requests are low or inexistent, and avoids that the electric pumps start too many times.

It is good practice to check the value of the maximum electric pump pressure to match the set with a vessel suitable for the pressure value

BOOSTER SETS GX5 AND GMD SERIES SELECTING THE PUMPS

What type of pump to choose?

Generally, the choice of pump is based on the take-off point of the system, which is usually the highest possible. As maximum demand normally lasts a short time, the pump must also be able to satisfy variable requests throughout its time in service.

In this case, if variability is elevated, variable speed booster sets are preferred.

Generally the choice of the pump, based on the performance curve, should fall around the maximum efficiency point. The pump must ensure operation within its rated performance.

Since the booster set is sized according to the maximum possible consumption, the take-off point of the pumps must be in the area on the right of the performance curve so that, if there is a fall in consumption, the efficiency remains high.

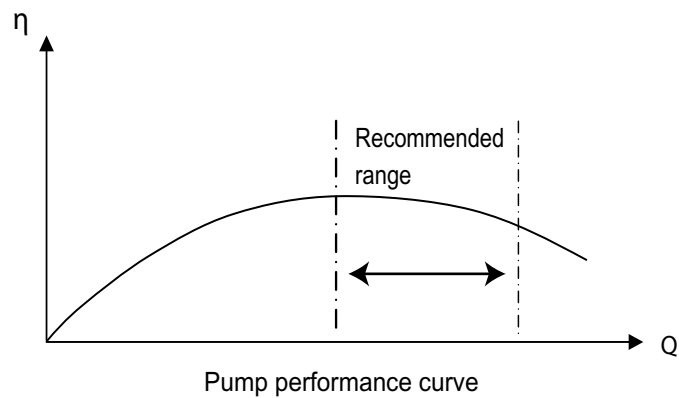

If we make a choice on the characteristic curve of the pump, we can see that the area where it is best to select the pump is represented by the following graph:

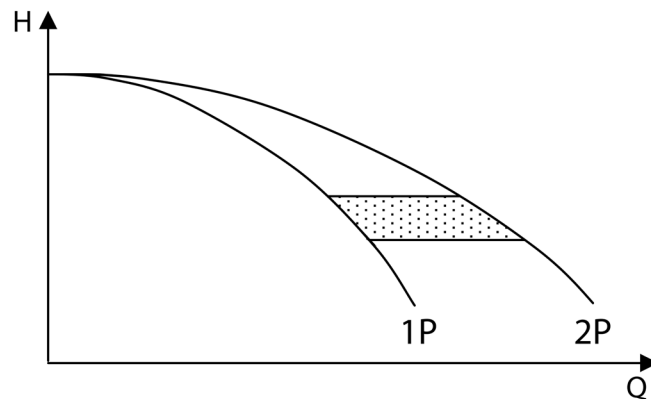

Another factor to be considered when choosing the pumps is its NPSH value. Never choose a pump where the take-off point is too far to the right of the NPSH curve.

This risks not having good pump suction, which may be aggravated by the type of installation (where negative suction is possible).

In these cases there is the risk of cavitation.

The NPSH of the pump must always be checked at the maximum flow rate requested.

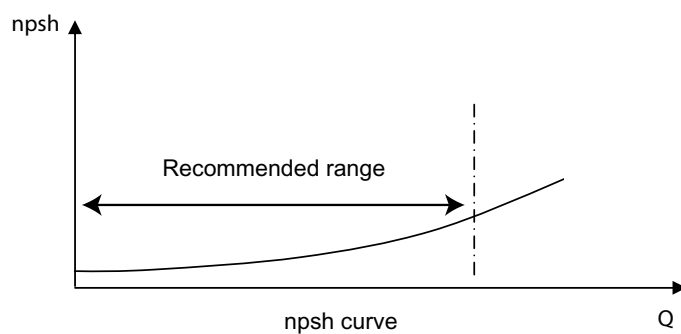

BOOSTER SETS GX5 AND GMD SERIES SELECTING THE PUMPS

The choice of pump is therefore based on the characteristic curve of the pump depending on the flow rate and the pressure required for the system. Starting from the required flow rate, a vertical line is drawn until it meets the horizontal line of the required pressure. The point of intersection of the lines gives both the type and the number of pumps necessary for the system.

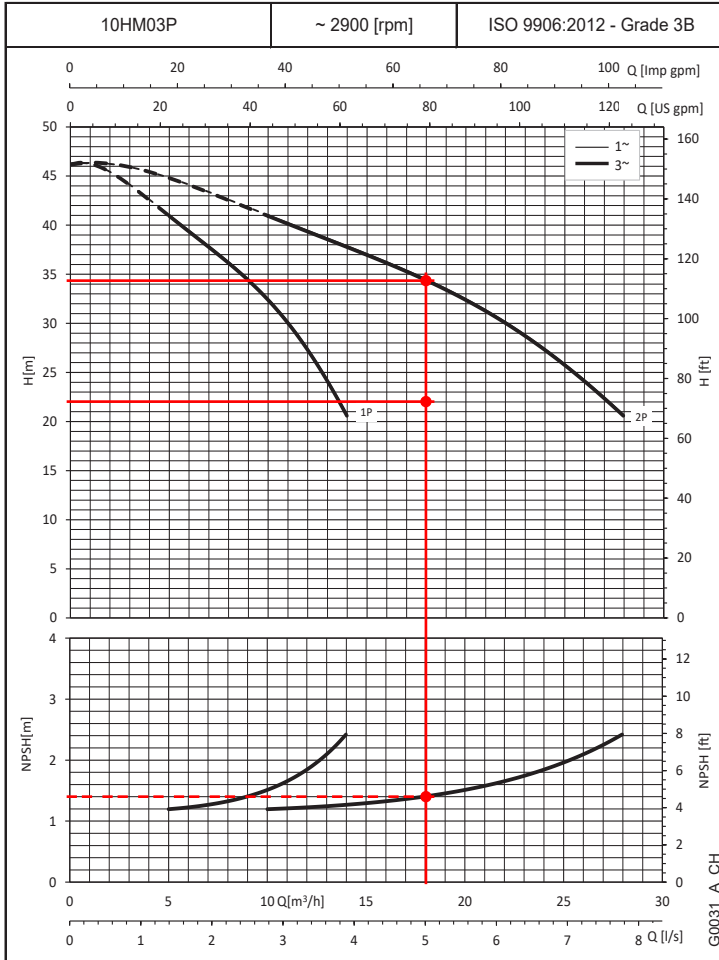

The example alongside refers to a required flow rate of 18 m³/h and a pressure of 22 water column.

As may be seen from the specific selection page 71, the system requires two pumps of the type 10HM03 as indicated top left in the table.

Moreover the take-off point falls in the npsH area farthest to the left and therefore in an area with a low cavitation risk.

The values obtained are those for the performance of the pumps. A correct check of the net pressure value must be made due to the intrinsic load loss of the booster set and the conditions of installation.

NPSH

The minimum operating values that can be reached at the pump suction end are limited by the onset of cavitation. Cavitation is the formation of vapour-filled cavities within liquids where the pressure is locally reduced to a critical value, or where the local pressure is equal to, or just below the vapour pressure of the liquid.

The vapour-filled cavities flow with the current and when they reach a higher pressure area the vapour contained in the cavities condenses. The cavities collide, generating pressure waves that are transmitted to the walls.

These, being subjected to stress cycles, gradually become deformed and yield due to fatigue.

This phenomenon, characterized by a metallic noise produced by the hammering on the pipe walls, is called incipient cavitation.

The damage caused by cavitation may be magnified by electrochemical corrosion and a local rise in temperature due to the plastic deformation of the walls. The materials that offer the highest resistance to heat and corrosion are alloy steels, especially austenitic steel.

The conditions that trigger cavitation may be assessed by calculating the total net suction head, referred to in technical literature with the acronym NPSH (Net Positive Suction Head).

The NPSH represents the total energy (expressed in m.) of the liquid measured at suction under conditions of incipient cavitation, excluding the vapour pressure (expressed in m.) that the liquid has at the pump inlet.

BOOSTER SETS GX5 AND GMD SERIES SUCTION CONDITIONS

Once the type and the number of electric pumps of the set have been identified, the suction conditions must also be assessed. Below is an example of the assessment of the suction lift installation conditions, in relation to the previously described case:

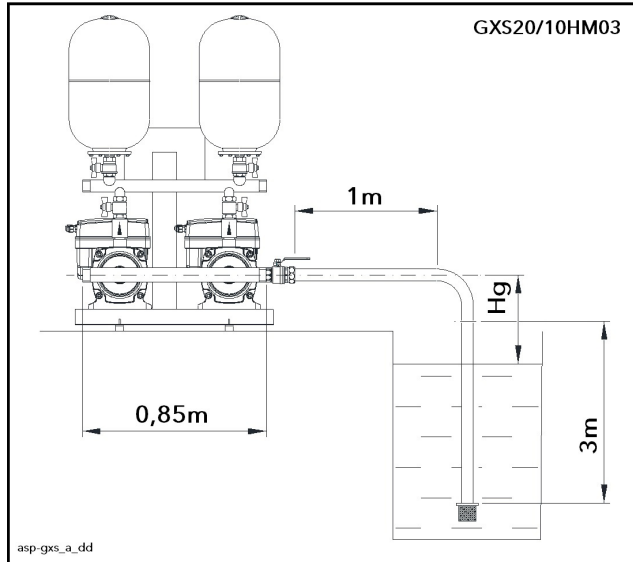

In suction lift installation, it is necessary to calculate the maximum Hg height which must not be exceeded due to safety reasons, to avoid cavitation, and therefore the unpriming of the pump itself. The relation that must be assessed, and which connects this value, is the following:

$NPSH_{available} \geq NPSH_{required}$, when the equality condition represents the limit condition.

$$NPSH_{available} = Patm + Hg - \sum t - \sum a$$

Where:

$Patm$ is the atmospheric pressure, equal to 10,33 m

Hg is the geodetic level difference

$\sum t$ are the pressure drops for suction components such as foot check valve, suction piping, curve, gate valve.

$\sum a$ are the pressure drops for suction set branch.

$NPSH_{requested}$ is a parameter obtained from the performance curve; in our case, at the flow of each pump

equal to 9 m³/h, it corresponds to 1,45 m (page 71). Before calculating the $NPSH_{available}$, it is necessary to calculate the pressure drops at the suction, using the tables on page 117-118, and taking into account the material, such as the type of stainless steel for the piping and cast iron for the valves.

The total sum of the pressure drops $\sum t$ for suction components is made in the following way, considering that the diameter of the suction piping is DN65, equal to the diameter of the suction manifold of the set (page 46).

Calculation of suction drops $\sum c$ for cast iron components

Equivalent piping length for DN65 foot check valve = 3 m

Equivalent piping length for DN65 gate valve = 0,2 m

Total equivalent length = 3 + 0,2 = 3,2 m

Pressure drops in the suction piping (cast iron) $\sum c = 3,2 \times 6,85 / 100 = 0,219$ m

Calculation of suction drops $\sum s$ for stainless steel components

Equivalent piping length for DN65 90° curve = 1,3 m

Total equivalent length = 1,3 m

Horizontal suction pipe length = 4 m

Vertical suction pipe length = 1 m

Pressure drops in the suction piping (stainless steel) $\sum s = (1,3 + 4 + 1) \times 6,85 \times 0,54 / 100 = 0,23$ m

Pressure drops for suction components $\sum t = \sum c + \sum s = 0,219 + 0,23 = 0,45$ m

The total sum of the pressure drops $\sum a$ for suction components is made in the following way, considering that the diameter of the suction piping is DN65, equal to the diameter of the suction manifold of the set (page 46). H_c pressure drops for suction set branch must be assessed on the B curve (page 98, schema B0367_A_CH); at the flow value of each pump equal to 9 m³/h, a value of $H_c = 1,25$ m is obtained.

Calculation of suction drops $\sum s$ for stainless steel components

Equivalent piping length for DN65 manifold T fitting = 2,6 m

Suction manifold length = 0,85 m

Pressure drops in the suction manifold (steel) $\sum s = (2,6 + 0,85) \times 6,85 \times 0,54 / 100 = 0,0127$ m

Pressure drops $\sum a = H_c + \sum s = 1,25 + 0,0127 = 1,377$ m

Remembering that $NPSH_{available} = Patm + Hg - \sum t - \sum a$ and that $NPSH_{available} \geq NPSH_{requested}$ we have that $Patm + Hg - \sum t - \sum a$ must be $\geq NPSH_{requested}$.

Substituting the values we get that $10,33 + Hg - 0,45 - 1,377 \geq 1,45$ m ($NPSH_{requested}$),

$Hg = 1,45 + 0,45 + 1,377 - 10,33 = - 9,8$ m, it represents the limit condition for which

$NPSH_{available} = NPSH_{requested}$

Therefore, in order to guarantee the conditions for the correct operation of the system as far as cavitation risks, it will be necessary to position the pump above the water level, **so that the Hg height is below the limit value of 9,8 m.**

BOOSTER SETS GX5 AND GMD SERIES NET PRESSURE CALCULATION

When selecting booster sets, the performance levels of the pump must be taken into account. Performance levels are obtained from the characteristic curves of the pumps, and do not take into account any pressure drops due to system piping and valves. The following example helps the customer to obtain the correct delivery manifold pressure value:

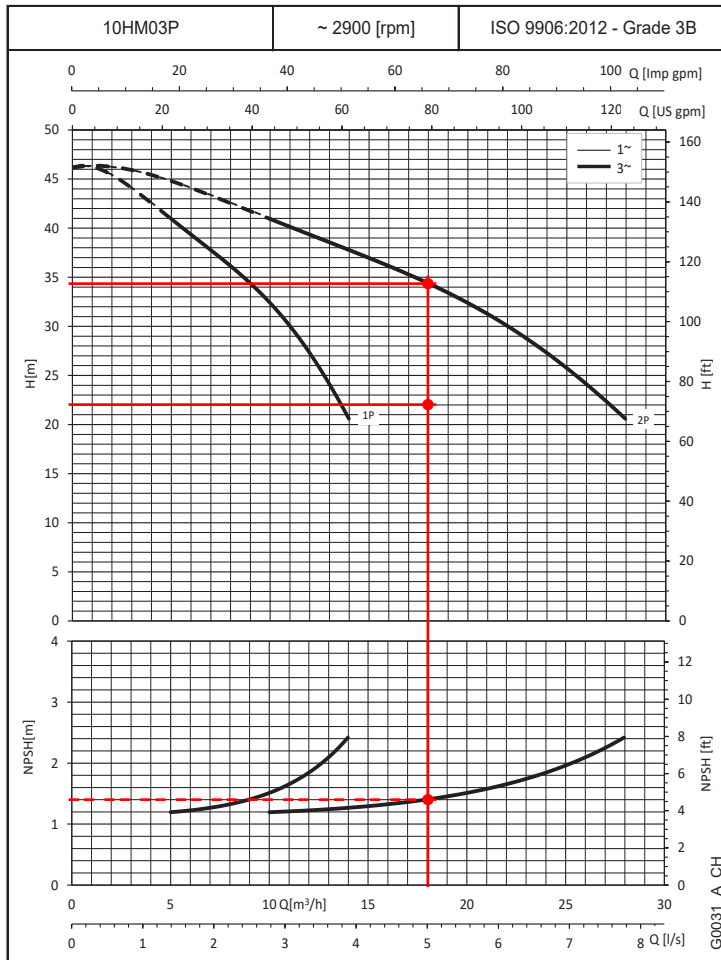

Knowing the system operating point $Q = 18$ m³/h and $H = 22$ mH₂O (P requested), and the installation height H_g (estimated to 5 m), in order to make the calculations easier we use the pressure drop curves for each single pump on page 125 of this catalogue. Assuming that a booster set GMD20/10HM03 with non-return valves on the delivery has been selected, we proceed as follows:

P net available \geq P requested, when the equality condition represents the limit condition.

$$\mathbf{P \text{ net available} = H - (H_g + \sum t + \sum a + \sum m)}$$

Where:

H head value of booster set

H_g is the geodetic level difference (estimated to 3 m)

$\sum t$ are the pressure drops for suction components such as foot check valve, suction piping, curve and gate valve.

$\sum a$ are the pressure drops for suction set branch

$\sum m$ are the pressure drops for delivery set branch

The total sum of the pressure drops $\sum t$ for suction components is made in the following way, considering that the diameter of the suction piping is DN65, equal to the diameter of the suction manifold of the set (page 46).

Calculation of suction drops $\sum c$ for cast iron components

Equivalent piping length for DN65 foot check valve = 3 m

Equivalent piping length for DN65 gate valve = 0,2 m

Total equivalent length = 3 + 0,2 = 3,2 m

Pressure drops in the suction piping (cast iron) $\sum c = 3,2 \times 6,85 / 100 = 0,219$ m

Calculation of suction drops $\sum s$ for stainless steel components:

Equivalent piping length for DN65 90° curve = 1,3 m

Total equivalent length = 1,3 m

Horizontal suction pipe length = 4 m

Vertical suction pipe length = 1 m

Pressure drops in the suction piping (stainless steel) $\sum s = (1,3 + 4 + 1) \times 6,85 \times 0,54 / 100 = 0,23$ m

The total sum of the pressure drops for suction components $\sum t = \sum c + \sum s = 0,219 + 0,23 = 0,45$ m

The total sum of the pressure drops $\sum t$ for suction components is made in the following way, considering that the diameter of the suction piping is DN65, equal to the diameter of the suction manifold of the set (page 46). H_c pressure drops for suction set branch must be assessed on the B curve (page 98, schema B0367_A_CH); at the flow value of each pump equal to 9 m³/h, a value of $H_c = 1,25$ m is obtained.

BOOSTER SETS GXS AND GMD SERIES NET PRESSURE CALCULATION

Calculation of suction drops $\sum s$ for stainless steel components

Equivalent piping length for DN65 manifold TEE fitting = 2,6 m

Suction manifold length = 0,85

Pressure drops in the suction piping (stainless steel) $\sum s = (2,6 + 0,85) \times 6,85 \times 0,54 / 100 = 0,127$ m

The total pressure drops $\sum a$ for suction components are:

$\sum a = H_c + \sum s = 1,25 + 0,127 = 1,377$ m

The total sum of the pressure drops $\sum m$ for delivery branch is made in the following way, considering that the diameter of the delivery manifold is DN65, equal to the diameter of the delivery manifold of the set (page 46). H_c pressure drops for delivery set branch must be assessed on the A curve (page 98, schema B0367_A_CH); at the flow value of each pump equal to 9 m³/h, a value of $H_c = 0,0028$ m is obtained.

Calculation of delivery drops $\sum s$ for stainless steel components

Equivalent piping length for DN65 manifold TEE fitting = 2,6 m

Delivery manifold length = 0,85 m

Pressure drops in the delivery manifold (steel) = $(2,6 + 0,85) \times 6,85 \times 0,54 / 100 = 0,127$ m

Pressure drops in delivery manifold $\sum m = H_c + \sum s = 0,0028 + 0,127 = 0,1298$ m

If we analyse the performance of the set at the flow value of 18 m³/h, the head value H is 33,5 m. The net pressure at the delivery manifold will be $P_{\text{net available}} = H - (H_g + \sum t + \sum a + \sum m)$

Substituting the values we get that $P_{\text{net available}} = 33,5 - (5 + 0,45 + 1,377 + 0,1298) = 26,545$ m

When comparing this value with the design value (not taking into account the dynamic energy), we see that $26,545 \text{ m} > 22 \text{ m}$ [$P_{\text{net available}} > P_{\text{Required}}$]

The set is therefore capable of meeting system requirements.

BOOSTER SETS GX5 AND GMD SERIES CHARACTERISTICS OF e-HM ELECTRIC PUMPS

PUMP DESIGN

The e-HM is a non-self-priming, end-suction horizontal multistage, high pressure centrifugal pump, with axial threaded inlet and radial threaded outlet. The pumps are close-coupled design and are equipped with non-standard Lowara motors. The e-HM is equipped with mechanical seal.

The e-HM are highly modular pumps that are fitted with an innovative hydraulic design that secures high efficiency performances and an increased Mean Time Between Failure.

The e-HM are available in two different configurations:

- "Compact" design for sizes 1HM, 3HM and 5HM up to 6 stages
- "Sleeve" design for sizes 1HM, 3HM and 5HM from 7 stages and above; any model of 10HM, 15HM and 22HM.

The "Compact" design is made of one single piece fabricated stainless steel pump body directly connected to the motor flange. The "Compact" has only one O-ring for the sealing of the casing that clearly reduces the leakages possibilities.

SPECIFICATIONS

PUMP

- Flow rate: up to 29 m³/h.
- Head: up to 159 m.
- Ambient temperature:
 - for single-phase version: from -15°C to +45°C.
 - for three-phase version: from -15°C to +50°C.
- Minimum temperature of the pumped liquid: from -10°C to -30°C according to gasket material.
- Maximum temperature of the pumped liquid:
 - for single-phase version: +90°C.
 - for three-phase version: up to +120°C depending on the model and the mechanical seal.
- Maximum operating pressure:
 - for pumps with technopolymer impeller: 10 bar (PN 10).
 - for pumps with stainless steel impeller: up to 16 bar (PN 16) depending on the model and the mechanical seal.
- Connections: Rp threaded for both suction and discharge manifold.
- Hydraulic performances compliant with ISO 9906:2012 - Grade 3B (ex ISO 9906:1999 - Annex A).



The "Sleeve" design is made of an external stainless steel TIG welded sleeve and of separate suction casing kept together with the mean of an aluminum casted pump bracket and of stainless steel tie rods screwed in the motor flange.

The e-HM is available in 3 different materials combination:

- HM..P: stainless steel pump body (EN 1.4301/AISI 304) with technopolymer impeller for sizes 1HM, 3HM, 5HM and 10HM up to 6 stages.
- HM..S: full stainless steel (EN 1.4301/AISI 304)
- HM..N: full stainless steel (EN 1.4401/AISI 316)

MOTOR

The e-HM are equipped with surface motors designed and manufactured in accordance with EN standards. The e-HM series can be equipped as well with variable speed drivers.

- Electric short-circuit squirrel-cage motor (TEFC), enclosed construction, air-cooled.
- 2-pole.
- IP 55 protection grade as motor only (EN 60034-5), IP X5 as electric pump (EN 60335-1).
- Insulation class 155 (F).
- Performances according to EN 60034-1.
- Standard voltage:
 - Single-phase: 220-240 V, 50 Hz.
 - Three-phase: 220-240/380-415 V, 50 Hz for powers up to 3 kW. 380/415/660-690 V, 50 Hz for powers above 3 kW.
- Efficiency class:
 - **IE2** for all single phase motors and for three-phase motors from 0,12 to 0,749 kW,
 - **IE3** for three-phase motors from 0,75 to 5,5 kW.

The e-HM pumps are certified for drinking water use (WRAS and ACS).

BOOSTER SETS GX5 AND GMD SERIES WITH ELECTRIC PUMPS e-HM HYDRAULIC PERFORMANCE RANGE AT 50 Hz

PUMP TYPE HM..P	VERSION	ELECTRIC PUMP			Q = DELIVERY							
		* P ₁ kW	P _N kW	MOTOR TYPE	l/min 0	40	56	72	88	104	120	140
					m ³ /h 0	2,4	3,4	4,3	5,3	6,2	7,2	8,4
H = TOTAL HEAD IN METRES OF COLUMN OF WATER												
3HM02	1 ~	2 x 0,49	2 x 0,55	SM71HM../1055	24,1	22,1	21,1	19,7	17,9	15,9	13,7	10,7
3HM03		2 x 0,63	2 x 0,55	SM71HM../1055	35,7	32,5	30,8	28,6	25,9	22,9	19,6	15,1
3HM04		2 x 0,76	2 x 0,55	SM71HM../1055	47,0	42,4	39,9	36,8	33,1	29,1	24,7	18,7
3HM05		2 x 0,96	2 x 0,75	SM80HM../1075	59,7	54,5	51,7	48,0	43,6	38,5	33,0	25,5
3HM06		2 x 1,16	2 x 1,1	SM80HM../1115	72,2	66,2	62,9	58,6	53,3	47,3	40,7	31,6
3HM02	3 ~	2 x 0,43	2 x 0,3	SM63HM../303	23,2	20,9	19,6	18,1	16,2	14,2	12,0	9,0
3HM03		2 x 0,57	2 x 0,4	SM63HM../304	34,9	31,3	29,3	26,9	24,2	21,1	17,8	13,4
3HM04		2 x 0,72	2 x 0,5	SM63HM../305	45,8	40,6	37,8	34,5	30,7	26,7	22,3	16,3
3HM05		2 x 0,92	2 x 0,75	SM80HM../307 E3	60,2	55,1	52,3	48,7	44,2	39,2	33,7	26,2
3HM06		2 x 1,10	2 x 1,1	SM80HM../311 E3	72,7	66,8	63,6	59,3	54,1	48,1	41,5	32,5

Hydraulic performances in compliance with ISO 9906:2012 - Grade 3B (ex ISO 9906:1999 - Annex A)

2p_3hm-p-2p50-en_b_th

* Maximum value in specified range: P1 = input power.

The table refers to performance with 2 pumps running.

PUMP TYPE HM..S	VERSION	ELECTRIC PUMP			Q = DELIVERY							
		* P ₁ kW	P _N kW	MOTOR TYPE	l/min 0	40	58	76	94	112	130	146,7
					m ³ /h 0	2,4	3,5	4,6	5,6	6,7	7,8	8,8
H = TOTAL HEAD IN METRES OF COLUMN OF WATER												
3HM10	1 ~	2 x 1,13	2 x 1,1	SM80HM../1115	75,5	74,1	71,2	66,8	61,0	53,5	44,1	33,3
3HM11		2 x 1,21	2 x 1,1	SM80HM../1115	82,8	81,2	77,8	73,0	66,5	58,3	47,8	35,9
3HM12		2 x 1,30	2 x 1,1	SM80HM../1115	90,2	88,2	84,4	79,1	72,0	62,9	51,4	38,5
3HM13		2 x 1,38	2 x 1,1	SM80HM../1115	97,4	95,1	91,0	85,1	77,3	67,3	54,9	40,9
3HM14		2 x 1,47	2 x 1,1	SM80HM../1115	104,7	101,9	97,4	90,9	82,4	71,7	58,2	43,0
3HM16		2 x 1,71	2 x 1,5	PLM90HM../1155	120,8	118,8	114,1	107,2	97,9	85,9	70,8	53,5
3HM17		2 x 1,80	2 x 1,5	PLM90HM../1155	128,2	125,9	120,8	113,4	103,5	90,7	74,6	56,2
3HM19		2 x 1,98	2 x 1,5	PLM90HM../1155	143	140	134	126	114	100,0	81,9	61,4
3HM10		3 ~	2 x 1,04	2 x 1,1	SM80HM../311 E3	75,9	74,8	71,9	67,7	62,0	54,8	45,5
3HM11	2 x 1,13		2 x 1,1	SM80HM../311 E3	83,3	82,0	78,7	74,0	67,8	59,8	49,5	37,3
3HM12	2 x 1,23		2 x 1,1	SM80HM../311 E3	90,7	89,1	85,5	80,3	73,4	64,6	53,4	40,1
3HM13	2 x 1,32		2 x 1,1	SM80HM../311 E3	98,1	96,1	92,2	86,5	79,0	69,5	57,3	42,8
3HM14	2 x 1,42		2 x 1,5	SM80HM../315 E3	106,1	104,5	100,4	94,4	86,5	76,3	63,3	47,8
3HM16	2 x 1,61		2 x 1,5	SM80HM../315 E3	121,0	118,7	113,9	107,0	97,8	86,1	71,1	53,4
3HM17	2 x 1,70		2 x 1,5	SM80HM../315 E3	128,3	125,8	120,7	113,2	103,4	90,9	75,0	56,1
3HM19	2 x 1,93		2 x 2,2	PLM90HM../322 E3	144,2	142,2	136,8	128,7	118,0	104,3	86,7	65,6
3HM21	2 x 2,11		2 x 2,2	PLM90HM../322 E3	159,1	156,6	150,5	141,5	129,6	114,3	94,7	71,5

Hydraulic performances in compliance with ISO 9906:2012 - Grade 3B (ex ISO 9906:1999 - Annex A)

2p_3hm-s-2p50-en_b_th

* Maximum value in specified range: P1 = input power.

The table refers to performance with 2 pumps running.

BOOSTER SETS GX5 AND GMD SERIES WITH ELECTRIC PUMPS e-HM HYDRAULIC PERFORMANCE RANGE AT 50 Hz

PUMP TYPE HM..P	VERSION	ELECTRIC PUMP			Q = DELIVERY							
		* P ₁ kW	P _N kW	MOTOR TYPE	l/min 0	80	106	132	158	184	210	240
					m ³ /h 0	4,8	6,4	7,9	9,5	11,0	12,6	14,4
H = TOTAL HEAD IN METRES OF COLUMN OF WATER												
5HM02	1 ~	2 x 0,59	2 x 0,55	SM71HM../1055	24,3	20,9	19,6	18,2	16,5	14,4	11,8	8,1
5HM03		2 x 0,78	2 x 0,55	SM71HM../1055	36,0	30,3	28,2	25,9	23,3	20,1	16,1	10,6
5HM04		2 x 1,03	2 x 0,75	SM80HM../1075	48,6	41,5	38,9	36,0	32,6	28,4	23,1	15,7
5HM05		2 x 1,29	2 x 1,1	SM80HM../1115	61,0	52,5	49,2	45,7	41,5	36,3	29,8	20,5
5HM06		2 x 1,50	2 x 1,1	SM80HM../1115	72,9	62,2	58,1	53,7	48,6	42,3	34,4	23,3
5HM02	3 ~	2 x 0,53	2 x 0,4	SM63HM../304	23,9	20,1	18,7	17,2	15,4	13,3	10,6	6,9
5HM03		2 x 0,73	2 x 0,5	SM63HM../305	35,2	28,8	26,5	24,2	21,5	18,2	14,2	8,6
5HM04		2 x 1,01	2 x 1,1	SM80HM../311 E3	49,3	42,9	40,4	37,7	34,5	30,4	25,2	17,8
5HM05		2 x 1,23	2 x 1,1	SM80HM../311 E3	61,4	53,1	49,9	46,4	42,3	37,2	30,6	21,3
5HM06		2 x 1,47	2 x 1,5	SM80HM../315 E3	73,8	64,0	60,2	56,1	51,2	45,0	37,3	26,1

Hydraulic performances in compliance with ISO 9906:2012 - Grade 3B (ex ISO 9906:1999 - Annex A)

2p_5hm-p-2p50-en_b_th

* Maximum value in specified range: P1 = input power.

The table refers to performance with 2 pumps running.

PUMP TYPE HM..S	VERSION	ELECTRIC PUMP			Q = DELIVERY							
		* P ₁ kW	P _N kW	MOTOR TYPE	l/min 0	#RIF!	114	148	182	216	250	284
					m ³ /h 0	4,8	6,8	8,9	10,9	13,0	15,0	17,0
H = TOTAL HEAD IN METRES OF COLUMN OF WATER												
5HM09	1 ~	2 x 1,50	2 x 1,1	SM80HM../1115	67,5	64,6	61,3	57,4	52,4	45,8	37,3	27,2
5HM10		2 x 1,71	2 x 1,5	PLM90HM../1155	75,6	73,3	70,0	66,0	60,7	53,6	44,4	33,1
5HM11		2 x 1,85	2 x 1,5	PLM90HM../1155	83,0	80,3	76,6	72,1	66,2	58,4	48,1	35,7
5HM12		2 x 1,99	2 x 1,5	PLM90HM../1155	90,4	87,2	83,1	78,1	71,6	63,0	51,8	38,3
5HM09	3 ~	2 x 1,48	2 x 1,5	SM80HM../315 E3	68,1	65,9	63,0	59,2	54,4	48,2	40,1	30,0
5HM10		2 x 1,63	2 x 1,5	SM80HM../315 E3	75,5	72,9	69,6	65,4	60,0	52,9	43,9	32,7
5HM11		2 x 1,77	2 x 1,5	SM80HM../315 E3	83,0	79,9	76,1	71,4	65,4	57,6	47,7	35,4
5HM12		2 x 1,97	2 x 2,2	PLM90HM../322 E3	91,0	88,3	84,4	79,5	73,1	64,7	54,0	40,6
5HM13		2 x 2,12	2 x 2,2	PLM90HM../322 E3	98,4	95,3	91,1	85,7	78,8	69,7	58,0	43,5
5HM14		2 x 2,27	2 x 2,2	PLM90HM../322 E3	106	102	97,8	91,9	84,3	74,5	61,9	46,2
5HM15		2 x 2,41	2 x 2,2	PLM90HM../322 E3	113	109	104	97,9	89,8	79,2	65,7	48,9
5HM17		2 x 2,76	2 x 3	PLM90HM../330 E3	129	125	119	112	103	91,2	75,9	56,9
5HM19		2 x 3,06	2 x 3	PLM90HM../330 E3	144	139	132	124	114	101	83,7	62,5
5HM21		2 x 3,35	2 x 3	PLM90HM../330 E3	159	153	146	137	125	110	91,3	67,8

Hydraulic performances in compliance with ISO 9906:2012 - Grade 3B (ex ISO 9906:1999 - Annex A)

2p_5hm-s-2p50-en_b_th

* Maximum value in specified range: P1 = input power.

The table refers to performance with 2 pumps running.

BOOSTER SETS GXS AND GMD SERIES WITH ELECTRIC PUMPS e-HM HYDRAULIC PERFORMANCE RANGE AT 50 Hz

PUMP TYPE HM..P	VERSION	ELECRTC PUMP			Q = DELIVERY							
		* P ₁ kW	P _N kW	MOTOR TYPE	l/min 0	166,7	216	266	316	366	416	466
					m ³ /h 0	10,0	13,0	16,0	19,0	22,0	25,0	28,0
H = TOTAL HEAD IN METRES OF COLUMN OF WATER												
10HM02	1 ~	2 x 1,28	2 x 1,1	SM80HM../1115	31,0	27,5	25,9	24,2	22,3	19,9	17,1	13,6
10HM03		2 x 1,82	2 x 1,5	PLM90HM../1155	46,2	41,0	38,7	36,3	33,5	30,2	25,9	20,7
10HM02	3 ~	2 x 1,23	2 x 1,1	SM80HM../311 E3	31,1	27,8	26,3	24,6	22,7	20,4	17,5	14,1
10HM03		2 x 1,75	2 x 1,5	SM80HM../315 E3	46,2	40,9	38,6	36,2	33,4	30,1	25,8	20,6
10HM04		2 x 2,34	2 x 2,2	PLM90HM../322 E3	61,2	55,7	52,7	49,6	46,2	42,0	36,7	30,3
10HM05		2 x 2,93	2 x 3	PLM90HM../330 E3	76,6	69,8	66,2	62,3	58,0	52,8	46,2	38,2
10HM06		2 x 3,47	2 x 3	PLM90HM../330 E3	91,7	83,0	78,5	73,8	68,5	62,2	54,3	44,6

Hydraulic performances in compliance with ISO 9906:2012 - Grade 3B (ex ISO 9906:1999 - Annex A)

2p_10hm-p-2p50-en_b_th

* Maximum value in specified range: P1 = input power.

The table refers to performance with 2 pumps running.

PUMP TYPE HM..S	VERSION	ELECRTC PUMP			Q = DELIVERY							
		* P ₁ kW	P _N kW	MOTOR TYPE	l/min 0	166,7	216	266	316	366	416	466
					m ³ /h 0	10,0	13,0	16	19,0	22	25,0	28
H = TOTAL HEAD IN METRES OF COLUMN OF WATER												
10HM08	3 ~	2 x 3,34	2 x 3	PLM90HM../330 E3	97	89	85,9	81,1	74,9	67,3	58,1	47,5
10HM09		2 x 3,75	2 x 4	PLM100HM../340 E3	109	102	98,3	93,1	86,3	77,9	67,7	55,7
10HM10		2 x 4,13	2 x 4	PLM100HM../340 E3	121	113	108,6	102,8	95,2	85,7	74,4	61,1
10HM11		2 x 4,51	2 x 4	PLM100HM../340 E3	133	124	119	112	104	93,5	81,0	66,4

Hydraulic performances in compliance with ISO 9906:2012 - Grade 3B (ex ISO 9906:1999 - Annex A)

2p_10hm-s-2p50-en_b_th

* Maximum value in specified range: P1 = input power.

The table refers to performance with 2 pumps running.

PUMP TYPE HM..S	VERSION	ELECRTC PUMP			Q = DELIVERY							
		* P ₁ kW	P _N kW	MOTOR TYPE	l/min 0	266	356	446	536	626	716	800
					m ³ /h 0	16	21,4	26,8	32,2	37,6	43,0	48
H = TOTAL HEAD IN METRES OF COLUMN OF WATER												
15HM02	3 ~	2 x 1,63	2 x 1,5	SM80HM../315 E3	28,8	26,3	25,2	23,8	21,8	19,2	15,7	11,7
15HM03		2 x 2,56	2 x 2,2	PLM90HM../322 E3	43,6	39,6	37,9	35,8	33,1	29,7	25,4	20,6
15HM04		2 x 3,40	2 x 3	PLM90HM../330 E3	58,1	52,8	50,6	47,7	44,2	39,6	33,8	27,4
15HM05		2 x 4,21	2 x 4	PLM100HM../340 E3	72,9	66,7	63,9	60,5	56,1	50,5	43,3	35,3

Hydraulic performances in compliance with ISO 9906:2012 - Grade 3B (ex ISO 9906:1999 - Annex A)

2p_15hm-s-2p50-en_b_th

* Maximum value in specified range: P1 = input power.

The table refers to performance with 2 pumps running.

PUMP TYPE HM..S	VERSION	ELECRTC PUMP			Q = DELIVERY							
		* P ₁ kW	P _N kW	MOTOR TYPE	l/min 0	#RIF!	466	566	666	766	866	966
					m ³ /h 0	22	28	34	40	46	52	58
H = TOTAL HEAD IN METRES OF COLUMN OF WATER												
22HM02	3 ~	2 x 2,36	2 x 2,2	PLM90HM../322 E3	30,2	28,0	26,7	25,0	22,7	19,5	15,4	10,4
22HM03		2 x 3,38	2 x 3	PLM90HM../330 E3	45,6	41,9	40,2	38,0	35,1	31,3	26,4	20,4
22HM04		2 x 4,44	2 x 4	PLM100HM../340 E3	61,0	56,3	54,0	51,1	47,3	42,3	35,8	27,9

Hydraulic performances in compliance with ISO 9906:2012 - Grade 3B (ex ISO 9906:1999 - Annex A)

2p_22hm-s-2p50-en_b_th

* Maximum value in specified range: P1 = input power.

The table refers to performance with 2 pumps running.

BOOSTER SETS GX S AND GMD SERIES WITH ELECTRIC PUMPS e-HM ELECTRICAL DATA TABLE

PUMP TYPE HM..P	VERSION	ELECTRIC PUMP			CURRENT ABSORBED GX S 1x(220-240)Vac A
		* P1 kW	PN kW	MOTOR TYPE	
3HM02	1 ~	2 X 0,49	2 X 0,55	SM71HM../1055	4,4
3HM03		2 X 0,63	2 X 0,55	SM71HM../1055	5,4
3HM04		2 X 0,76	2 X 0,55	SM71HM../1055	6,6
3HM05		2 X 0,96	2 X 0,75	SM80HM../1075	8,4
3HM06		2 X 1,16	2 X 1,1	SM80HM../1115	10,2
					GMD 3x(380-415)Vac A
3HM02	3 ~	2 X 0,43	2 X 0,3	SM63HM../303	2,2
3HM03		2 X 0,57	2 X 0,4	SM63HM../304	2,7
3HM04		2 X 0,72	2 X 0,5	SM63HM../305	3,1
3HM05		2 X 0,92	2 X 0,75	SM80HM../307 E3	3,4
3HM06		2 X 1,1	2 X 1,1	SM80HM../311 E3	4,3
					GMD 3x(380-415)Vac A
PUMP TYPE HM..S	VERSION	ELECTRIC PUMP			CURRENT ABSORBED GX S 1x(220-240)Vac A
		* P1 kW	PN kW	MOTOR TYPE	
3HM10	1 ~	2 X 1,126	2 X 1,1	SM80HM../1115	9,9
3HM11		2 X 1,211	2 X 1,1	SM80HM../1115	10,6
3HM12		2 X 1,297	2 X 1,1	SM80HM../1115	11,4
3HM13		2 X 1,384	2 X 1,1	SM80HM../1115	12,2
3HM14		2 X 1,47	2 X 1,1	SM80HM../1115	13,1
3HM16		2 X 1,713	2 X 1,5	PLM90HM../1155	15,5
3HM17		2 X 1,801	2 X 1,5	PLM90HM../1155	16,3
3HM19		2 X 1,978	2 X 1,5	PLM90HM../1155	17,9
					GMD 3x(380-415)Vac A
3HM10	3 ~	2 X 1,04	2 X 1,1	SM80HM../311 E3	4,2
3HM11		2 X 1,13	2 X 1,1	SM80HM../311 E3	4,4
3HM12		2 X 1,23	2 X 1,1	SM80HM../311 E3	4,6
3HM13		2 X 1,32	2 X 1,1	SM80HM../311 E3	4,8
3HM14		2 X 1,42	2 X 1,5	SM80HM../315 E3	5,6
3HM16		2 X 1,61	2 X 1,5	SM80HM../315 E3	6,0
3HM17		2 X 1,70	2 X 1,5	SM80HM../315 E3	6,3
3HM19		2 X 1,93	2 X 2,2	PLM90HM../322 E3	7,8
3HM21		2 X 2,11	2 X 2,2	PLM90HM../322 E3	8,3

The current shown is the nominal current of set

2p_catemea_3hm-p-s-2p50-en_b_te

* Maximum value in specific range: P1 = input power

BOOSTER SETS GX5 AND GMD SERIES WITH ELECTRIC PUMPS e-HM ELECTRICAL DATA TABLE

PUMP TYPE HM..P	VERSION	ELECTRIC PUMP			CURRENT ABSORBED GX5 1x(220-240)Vac A
		* P1 kW	PN kW	MOTOR TYPE	
5HM02	1 ~	2 X 0,59	2 X 0,55	SM71HM../1055	5,1
5HM03		2 X 0,78	2 X 0,55	SM71HM../1055	6,7
5HM04		2 X 1,03	2 X 0,75	SM80HM../1075	9,2
5HM05		2 X 1,29	2 X 1,1	SM80HM../1115	11,3
5HM06		2 X 1,50	2 X 1,1	SM80HM../1115	13,3
					GMD 3x(400-415)Vac A
5HM02	3 ~	2 X 0,53	2 X 0,4	SM63HM../304	2,7
5HM03		2 X 0,73	2 X 0,5	SM63HM../305	3,1
5HM04		2 X 1,01	2 X 1,1	SM80HM../311 E3	4,2
5HM05		2 X 1,23	2 X 1,1	SM80HM../311 E3	4,6
5HM06		2 X 1,47	2 X 1,5	SM80HM../315 E3	5,7
					GMD 3x(400-415)Vac A
PUMP TYPE HM..S	VERSION	ELECTRIC PUMP			CURRENT ABSORBED GX5 1x(220-240)Vac A
		* P1 kW	PN kW	MOTOR TYPE	
5HM09	1 ~	2 X 1,50	2 X 1,1	SM80HM../1115	13,4
5HM10		2 X 1,71	2 X 1,5	PLM90HM../1155	15,5
5HM11		2 X 1,85	2 X 1,5	PLM90HM../1155	16,7
5HM12		2 X 1,99	2 X 1,5	PLM90HM../1155	18,0
					GMD 3x(400-415)Vac A
5HM09	3 ~	2 X 1,48	2 X 1,5	SM80HM../315 E3	5,7
5HM10		2 X 1,63	2 X 1,5	SM80HM../315 E3	6,1
5HM11		2 X 1,77	2 X 1,5	SM80HM../315 E3	6,4
5HM12		2 X 1,97	2 X 2,2	PLM90HM../322 E3	7,9
5HM13		2 X 2,12	2 X 2,2	PLM90HM../322 E3	8,2
5HM14		2 X 2,27	2 X 2,2	PLM90HM../322 E3	8,6
5HM15		2 X 2,41	2 X 2,2	PLM90HM../322 E3	8,9
5HM17		2 X 2,76	2 X 3	PLM90HM../330 E3	11,3
5HM19		2 X 3,06	2 X 3	PLM90HM../330 E3	11,9
5HM21		2 X 3,35	2 X 3	PLM90HM../330 E3	12,6

The current shown is the nominal current of set

2p_catemea_5hm-p-s-2p50-en_b_te

* Maximum value in specific range: P1 = input power

BOOSTER SETS GX S AND GMD SERIES WITH ELECTRIC PUMPS e-HM ELECTRICAL DATA TABLE

PUMP TYPE HM..P	VERSION	ELECTRIC PUMP			CURRENT ABSORBED
		* P1 kW	MOTOR		GXS 1x(220-240)Vac A
			PN kW	TYPE	
10HM02	1 ~	2 X 1,28	2 X 1,1	SM80HM../1115	11,3
10HM03		2 X 1,82	2 X 1,5	PLM90HM../1155	16,5
					GMD 3x(380-415)Vac A
10HM02	3 ~	2 X 1,23	2 X 1,1	SM80HM../311 E3	4,6
10HM03		2 X 1,75	2 X 1,5	SM80HM../315 E3	6,3
10HM04		2 X 2,34	2 X 2,2	PLM90HM../322 E3	8,8
10HM05		2 X 2,93	2 X 3	PLM90HM../330 E3	11,7
10HM06		2 X 3,47	2 X 3	PLM90HM../330 E3	12,9
PUMP TYPE HM..S	VERSION	ELECTRIC PUMP			CURRENT ABSORBED
		* P1 kW	MOTOR		GMD 3x(380-415)Vac A
			PN kW	TYPE	
10HM08	3 ~	2 X 3,34	2 X 3	PLM90HM../330 E3	12,6
10HM09		2 X 3,75	2 X 4	PLM100HM../340 E3	13,5
10HM10		2 X 4,13	2 X 4	PLM100HM../340 E3	14,4
10HM11		2 X 4,51	2 X 4	PLM100HM../340 E3	15,4

The current shown is the nominal current of set

2p_catemea_10hm-p-s-2p50-en_b_te

* Maximum value in specific range: P1 = input power

PUMP TYPE HM..S	VERSION	ELECTRIC PUMP			CURRENT ABSORBED
		* P1 kW	MOTOR		GMD 3x(380-415)Vac A
			PN kW	TYPE	
15HM02	3 ~	2 X 1,63	2 X 1,5	SM80HM../315 E3	6,1
15HM03		2 X 2,56	2 X 2,2	PLM90HM../322 E3	9,3
15HM04		2 X 3,40	2 X 3	PLM90HM../330 E3	12,8
15HM05		2 X 4,21	2 X 4	PLM100HM../340 E3	14,6

The current shown is the nominal current of set

2p_catemea_15hm-s-2p50-en_b_te

* Maximum value in specific range: P1 = input power

PUMP TYPE HM..S	VERSION	ELECTRIC PUMP			CURRENT ABSORBED
		* P1 kW	MOTOR		GMD 3x(380-415)Vac A
			PN kW	TYPE	
22HM02	3 ~	2 X 2,37	2 X 2,2	PLM90HM../322 E3	8,8
22HM03		2 X 3,38	2 X 3	PLM90HM../330 E3	12,7
22HM04		2 X 4,44	2 X 4	PLM100HM../340 E3	15,1

The current shown is the nominal current of set

2p_catemea_22hm-s-2p50-en_b_te

* Maximum value in specific range: P1 = input power

BOOSTER SETS GX5 AND GMD SERIES WITH ELECTRIC PUMPS e-HM SINGLE-PHASE MOTORS, 2 POLES AT 50 Hz

P _N kW	MOTOR TYPE	IEC SIZE	Construction Design	INPUT CURRENT			CAPACITOR		DATA FOR 230 V 50 Hz VOLTAGE						OPERATING CONDITIONS **		
				In (A) 220-240 V	μF	V	min ⁻¹	Is / In	η %	cosφ	T _N Nm	Ts/T _N	Tm/T _N	Altitude asl m	T. amb min/max °C	ATEX	
0,55	SM71HM../1055 E2	71	SPECIAL	3,33-3,19	16	450	2810	4,16	74,1	0,99	1,87	0,69	2,13	≤ 1000	-15/45	No	
0,75	SM80HM../1075 E2	80		4,38-4,27	25	450	2865	5,11	77,4	0,97	2,50	0,40	2,26				
1,1	SM80HM../1115 E2	80		6,26-5,93	30	450	2860	4,78	79,6	0,98	3,67	0,50	2,14				
1,5	PLM90HM../1155 E2	90		8,41-7,87	50	450	2890	6,71	81,3	0,97	4,95	0,59	2,78				

** Operating conditions related only to the motor. For the electric pump refer to the IOM.

1-22hm-motm_2p50-en_c_te

THREE-PHASE MOTORS, 2 POLES AT 50 Hz

P _N kW	Manufacturer		IEC SIZE	Construction Design	N. of Poles	f _N Hz	Data for 400 V / 50 Hz Voltage				
	Xylem Service Italia Srl Reg. No. 07520560967 Montecchio Maggiore Vicenza - Italia						cosφ	Is / I _N	T _N Nm	Ts/T _N	Tm/T _N
0,30	SM63HM../303		63	SPECIAL	2	50	0,63	4,20	1,04	4,18	4,12
0,40	SM63HM../304		63				0,64	4,35	1,37	4,14	4,10
0,50	SM63HM../305		63				0,69	4,72	1,75	4,08	4,00
0,55	SM71HM../305		71				0,71	6,25	1,84	3,96	3,97
0,75	SM80HM../307 E3		80				0,78	7,38	2,48	3,57	3,75
1,1	SM80HM../311 E3		80				0,79	8,31	3,63	3,95	3,95
1,5	SM80HM../315 E3		80				0,80	8,80	4,96	4,31	4,10
2,2	PLM90HM../322 E3		90				0,80	8,77	7,28	3,72	3,70
3	PLM90HM../330 E3		90				0,79	7,81	9,93	4,26	3,94
4	PLM100HM../340 E3		100				0,85	9,13	13,2	3,82	4,32
5,5	PLM112HM../355 E3		112	0,85	10,5	18,1	4,74	5,11			

P _N kW	Voltage U _N V											n _N min ⁻¹	Operating conditions **		
	Δ			Y			Δ			Y			Altitude Above Sea Level (m)	T. amb min/max °C	ATEX
	220 V	230 V	240 V	380 V	400 V	415 V	380 V	400 V	415 V	660 V	690 V				
	I _N (A)														
0,30	1,66	1,82	1,96	0,96	1,05	1,13	-	-	-	-	-	2715 ÷ 2775	≤ 1000	-15 / 50	No
0,40	2,03	2,18	2,32	1,17	1,26	1,34	-	-	-	-	-	2745 ÷ 2800			
0,50	2,42	2,51	2,65	1,40	1,45	1,53	-	-	-	-	-	2690 ÷ 2765			
0,55	2,46	2,49	2,56	1,42	1,44	1,48	-	-	-	-	-	2835 ÷ 2865			
0,75	2,96	2,94	2,96	1,71	1,70	1,71	1,70	1,69	1,70	0,98	0,98	2875 ÷ 2895			
1,1	4,19	4,14	4,16	2,42	2,39	2,40	2,41	2,38	2,38	1,39	1,37	2870 ÷ 2900			
1,5	5,56	5,49	5,51	3,21	3,17	3,18	3,21	3,18	3,19	1,85	1,84	2870 ÷ 2895			
2,2	7,97	7,90	7,98	4,60	4,56	4,61	4,57	4,54	4,57	2,64	2,62	2880 ÷ 2900			
3	11,0	11,0	11,2	6,35	6,33	6,44	6,29	6,27	6,34	3,63	3,62	2865 ÷ 2895			
4	13,6	13,4	13,4	7,87	7,75	7,74	7,80	7,62	7,61	4,50	4,40	2885 ÷ 2910			
5,5	18,1	17,9	18,1	10,4	10,4	10,4	10,6	10,5	10,7	6,10	6,05	2880 ÷ 2910			

P _N kW	Efficiency η _N %																		IE
	Δ 220 V Y 380 V			Δ 230 V Y 400 V			Δ 240 V Y 415 V			Δ 380 V Y 660 V			Δ 400 V Y 690 V			Δ 415 V			
	4/4	3/4	2/4	4/4	3/4	2/4	4/4	3/4	2/4	4/4	3/4	2/4	4/4	3/4	2/4	4/4	3/4	2/4	
0,30	67,1	69,6	65,0	67,1	66,5	60,2	67,1	63,3	55,7	-	-	-	-	-	-	-	-	-	2
0,40	70,4	73,2	68,9	70,4	70,3	64,5	70,4	67,2	60,2	-	-	-	-	-	-	-	-	-	
0,50	73,0	76,1	73,4	73,0	73,8	69,6	73,0	71,3	65,7	-	-	-	-	-	-	-	-	-	
0,55	74,1	74,2	70,4	74,1	73,6	68,8	74,1	72,7	67,1	-	-	-	-	-	-	-	-	-	
0,75	82,5	83,1	81,3	82,8	82,7	80,1	82,6	82,0	78,9	82,5	82,0	78,9	82,5	82,0	78,9	82,5	82,0	78,9	3
1,1	84,0	84,7	83,4	84,4	84,5	82,5	84,3	84,0	81,4	84,0	84,0	81,4	84,0	84,0	81,4	84,0	84,0	81,4	
1,5	85,6	86,5	85,8	85,9	86,4	84,9	86,0	86,0	84,0	85,6	86,0	84,0	85,6	86,0	84,0	85,6	86,0	84,0	
2,2	86,5	87,4	86,8	86,4	86,9	85,7	86,6	86,7	85,0	86,4	86,7	85,0	86,4	86,7	85,0	86,4	86,7	85,0	
3	87,2	88,5	88,3	87,5	88,2	87,5	87,5	87,8	86,4	87,2	87,8	86,4	87,2	87,8	86,4	87,2	87,8	86,4	
4	89,1	90,1	89,2	89,1	90,1	89,2	89,1	90,1	89,2	89,1	90,3	90,4	89,6	90,4	89,9	89,6	90,1	89,2	
5,5	89,5	89,6	88,0	89,5	89,6	88,0	89,5	89,6	88,0	89,5	90,3	89,9	89,7	90,0	89,0	89,6	89,6	88,0	

** Operating conditions to be referred to motor only. About electric pump, refer to limits in user's manual.

1-22HM-ie3-mott-2p50-en_c_te

BOOSTER SETS GX5 AND GMD SERIES CHARACTERISTICS OF CEA ELECTRIC PUMPS

PUMP DESIGN

- Close-coupled, single-impeller centrifugal pump featuring axial suction and radial discharge.
- Compact construction, with pump coupled directly to motor; special motor shaft extension in common with the pump and supported by ball bearings.
- Rotating assembly with back pull-out design, eliminating the need to disconnect the pump body from the pipe line.
- Threaded suction and discharge ports (Rp ISO 7).
- High performance enclosed impeller made of **AISI 304** stainless steel (**AISI 316** for N version).
- **Mechanical seal** with Ceramic/Carbon rings, NBR elastomers, (EPDM for N version) other parts are made of AISI 304 stainless steel (AISI 316 for N version). Mounting dimensions according to EN 12756 (ex DIN 24960) and ISO 3069.
- **O-rings** made of NBR (EPDM for N version).



SPECIFICATIONS

PUMP

- Delivery up to **31 m³/h**.
- Head up to **32 m**.
- Temperature of pumped liquid:
from -10°C to +85°C for CEA (NBR elastomers).
from -10°C to +110°C for CEA..N and for CEA..V (FKM elastomers).
- Maximum operating pressure: **8 bar** (PN 8).
- Hydraulic performance compliant with ISO 9906:2012 (Grade 3B). (ex ISO 9906:1999 - Annex A).
- Counter-clockwise rotation facing the pump from the suction port.

MOTOR

- Asynchronous, squirrel cage rotor, close construction, external ventilation.
- Protection class:
IP55 as motor (EN 60034-1).
IPX5 as electric pump (EN 60335-1).
- **Class 155** (F) Insulation
- Performance to EN 60034-1 specifications.
- **Standard voltage:**
 - Single-phase version: 220-240 V, 50 Hz
 - Three-phase version: 220-240/380-415 V, 50 Hz.
- Condensate drain plugs in the standard version.

BOOSTER SETS GXS AND GMD SERIES WITH ELECTRIC PUMPS CEA HYDRAULIC PERFORMANCE TABLE AT 50 Hz

PUMP TYPE	VERSION	ELECTRIC PUMP			MEI \approx (1)	Q = DELIVERY									
		* P ₁ kW	P _N kW	MOTOR TYPE		l/min 0	60	90	120	150	180	210	240	270	320
						m ³ /h 0	3,6	5,4	7,2	9,0	10,8	12,6	14,4	16,2	19,2
H = TOTAL HEAD IN METRES OF COLUMN OF WATER															
70/3	1 ~	2 X 0,55	2 X 0,4	SM63BG/1045	-	22,2	20,2	18,8	16,8	14,1					
70/5		2 X 0,91	2 X 0,75	SM80BG/1075	-	31,9	29,7	28,3	26,0	22,8					
80/5		2 X 1,06	2 X 1,1	SM80BG/1115	-	32,6	30,6	29,6	28,3	26,5	24,1				
120/3		2 X 0,79	2 X 0,55	SM71BG/1055	0,40	22,3			18,7	17,6	16,5	15,1	13,6	11,9	8,7
120/5		2 X 1,30	2 X 1,1	SM80BG/1115	0,40	32,1			28,5	27,4	26,1	24,6	22,9	21,0	17,6
70/3	3 ~	2 x 0,61	2 x 0,4	SM63BG/304	-	22,1	20,0	18,7	16,6	13,8					
70/5		2 x 0,88	2 x 0,55	SM71BG/305	-	31,1	28,8	27,2	24,8	21,5					
80/5		2 x 0,98	2 x 0,75	SM80BG/307 PE	-	32,1	30,0	28,9	27,4	25,5	23,0				
120/3		2 x 0,82	2 x 0,55	SM71BG/305	0,40	22,5			18,9	17,9	16,8	15,5	14,0	12,3	9,1
120/5		2 x 1,28	2 x 1,1	SM80BG/311 PE	0,40	31,9			28,2	27,0	25,7	24,1	22,4	20,5	17,1

PUMP TYPE	VERSION	ELECTRIC PUMP			MEI \approx (1)	Q = DELIVERY									
		* P ₁ kW	P _N kW	MOTOR TYPE		l/min 0	240	280	320	360	400	440	480	520	600
						m ³ /h 0	14,4	16,8	19,2	21,6	24,0	26,4	28,8	31,2	36,0
H = TOTAL HEAD IN METRES OF COLUMN OF WATER															
210/2	1 ~	2 X 1,11	2 X 1,1	SM80BG/1115	0,40	17,9	16,9	16,5	16,1	15,6	15,0	14,4	13,7	12,9	11,1
210/3		2 X 1,37	2 X 1,1	SM80BG/1115	0,40	20,7	19,6	19,3	18,9	18,4	17,9	17,3	16,7	15,9	14,2
210/4		2 X 1,81	2 X 1,5	PLM90BG/1155	0,40	25,6	24,9	24,5	24,1	23,7	23,1	22,4	21,7	20,9	19,1
210/2	3 ~	2 x 1,04	2 x 0,75	SM80BG/307 PE	0,40	17,7	16,5	16,1	15,6	15,1	14,4	13,8	13,0	12,2	10,4
210/3		2 x 1,35	2 x 1,1	SM80BG/311 PE	0,40	20,8	19,7	19,4	19,0	18,6	18,0	17,5	16,8	16,1	14,4
210/4		2 x 1,73	2 x 1,5	SM80BG/315 PE	0,40	25,6	24,8	24,5	24,1	23,6	23,0	22,4	21,6	20,8	19,0
210/5		2 x 2,2	2 x 2,2	PLM90BG/322 E3	0,40	29,0	28,2	27,9	27,5	27,1	26,6	26,0	25,4	24,7	23,1

PUMP TYPE	VERSION	ELECTRIC PUMP			MEI \approx (1)	Q = DELIVERY									
		* P ₁ kW	P _N kW	MOTOR TYPE		l/min 0	360	450	540	630	720	810	900	990	1040
						m ³ /h 0	21,6	27,0	32,4	37,8	43,2	48,6	54,0	59,4	62,4
H = TOTAL HEAD IN METRES OF COLUMN OF WATER															
370/1	1 ~	2 X 1,4	2 X 1,1	SM80BG/1115	0,40	16,3	15,5	14,7	13,7	12,4	10,9	9,1			
370/2		2 X 1,95	2 X 1,5	PLM90BG/1155	0,40	20,4		18,8	17,9	16,9	15,6	14,1	12,3		
370/1	3 ~	2 x 1,4	2 x 1,1	SM80BG/311 PE	0,40	16,3	15,5	14,8	13,8	12,6	11,0	9,2			
370/2		2 x 1,95	2 x 1,5	SM80BG/315 PE	0,40	20,4		18,7	17,9	16,8	15,5	13,9	12,1		
370/3		2 x 2,45	2 x 2,2	PLM90BG/322 E3	0,40	24,4		22,5	21,7	20,7	19,5	18,1	16,3	14,3	13,0
370/5		2 x 3,26	2 x 3	PLM90BG/330 E3	0,40	30,3		27,9	27,1	26,2	25,0	23,6	22,0	20,2	19,0

Hydraulic performances in compliance with ISO 9906:2012 - Grade 3B (ex ISO 9906:1999 - Annex A)

2p_cea-2p50-en_b_th

* Maximum value in specified range: P₁ = input power.

(1) Minimum efficiency index MEI

The table refers to performance with 2 pumps running.

**BOOSTER SETS GX S AND GMD SERIES
 WITH ELECTRIC PUMPS CEA
 HYDRAULIC PERFORMANCE TABLE AT 50 Hz**

PUMP TYPE	VERSION	ELECTRIC PUMP			CURRENT ABSORBED
		* P1 kW	PN kW	MOTOR TYPE	
CEAM 70/3	1 ~	2 X 0,55	2 X 0,4	SM63BG/1045	GXS 1x(220-240)Vac A 4,7
CEAM 70/5		2 X 0,91	2 X 0,75	SM80BG/1075	8,1
CEAM 80/5		2 X 1,06	2 X 1,1	SM80BG/1115	9,4
CEAM 120/3		2 X 0,79	2 X 0,55	SM71BG/1055	6,9
CEAM 120/5		2 X 1,30	2 X 1,1	SM80BG/1115	11,5
					GMD 3x(380-415)Vac A
CEA 70/3	3 ~	2 x 0,61	2 x 0,4	SM63BG/304	2,9
CEA 70/5		2 x 0,88	2 x 0,55	SM71BG/305	3,3
CEA 80/5		2 x 0,98	2 x 0,75	SM80BG/307 PE	3,6
CEA 120/3		2 x 0,82	2 x 0,55	SM71BG/305	3,2
CEA 120/5		2 x 1,28	2 x 1,1	SM80BG/311 PE	4,7

PUMP TYPE	VERSION	ELECTRIC PUMP			CURRENT ABSORBED
		* P1 kW	PN kW	MOTOR TYPE	
CEAM 210/2	1 ~	2 X 1,11	2 X 1,1	SM80BG/1115	GXS 1x(220-240)Vac A 9,8
CEAM 210/3		2 X 1,37	2 X 1,1	SM80BG/1115	12,2
CEAM 210/4		2 X 1,81	2 X 1,5	PLM90BG/1155	16,5
					GMD 3x(380-415)Vac A
CEA 210/2	3 ~	2 x 1,04	2 x 0,75	SM80BG/307 PE	3,7
CEA 210/3		2 x 1,35	2 x 1,1	SM80BG/311 PE	4,9
CEA 210/4		2 x 1,73	2 x 1,5	SM80BG/315 PE	6,3
CEA 210/5		2 x 2,2	2 x 2,2	PLM90BG/322 E3	8,5

PUMP TYPE	VERSION	ELECTRIC PUMP			CURRENT ABSORBED
		* P1 kW	PN kW	MOTOR TYPE	
CEAM 370/1	1 ~	2 X 1,43	2 X 1,1	SM80BG/1115	GXS 1x(220-240)Vac A 12,6
CEAM 370/2		2 X 1,95	2 X 1,5	PLM90BG/1155	17,7
					GMD 3x(380-415)Vac A
CEA 370/1	3 ~	2 x 1,4	2 x 1,1	SM80BG/311 PE	5,0
CEA 370/2		2 x 1,95	2 x 1,5	SM80BG/315 PE	6,9
CEA 370/3		2 x 2,45	2 x 2,2	PLM90BG/322 E3	9,1
CEA 370/5		2 x 3,26	2 x 3	PLM90BG/330 E3	11,7

The current shown is the nominal current of set

2p_cea-2p50-en_b_te

* Maximum value in specific range:P1 = input power

BOOSTER SETS GX5 AND GMD SERIES WITH ELECTRIC PUMPS CEA SINGLE-PHASE MOTORS, 2 POLES AT 50 Hz

P _N kW	MOTOR TYPE	IEC SIZE	Construction Design	INPUT CURRENT I _N (A)	CAPACITOR		DATA FOR 230 V 50 Hz VOLTAGE						OPERATING CONDITIONS*			
					μF	V	min ⁻¹	Is / I _N	η %	cosφ	T _N Nm	Ts/T _N	Tm/T _N	Altitude asl m	T. amb min/max °C	ATEX
0,4	SM63BG/1045	63	SPECIAL	220-240 V	16	450	2800	3,24	70,4	0,99	1,36	0,66	1,98	≤ 1000	-15/45	No
0,55	SM71BG/1055	71		3,33-3,19	16	450	2810	4,16	74,1	0,99	1,87	0,69	2,13			
0,75	SM80BG/1075	80		4,38-4,27	25	450	2865	5,11	77,4	0,97	2,50	0,40	2,26			
1,1	SM80BG/1115	80		6,26-5,93	30	450	2860	4,78	79,6	0,98	3,67	0,50	2,14			
1,5	PLM90CEA-CO/1155 E2	90		8,41-7,87	50	450	2890	6,71	81,3	0,97	4,95	0,59	2,78			

** Operating conditions related only to the motor. For the electric pump refer to the IOM.

cea-motm-2p50-en_d_te

THREE-PHASE MOTORS, 2 POLES AT 50 Hz

P _N kW	Manufacturer		IEC SIZE	Construction Design	N. of Poles	f _N Hz	Data for 400 V / 50 Hz Voltage				
	Xylem Service Italia Srl Reg. No. 07520560967 Montecchio Maggiore Vicenza - Italia						cosφ	Is / I _N	T _N Nm	Ts/T _N	Tm/T _N
	Model										
0,4	SM63BG/304		63	SPECIALE	2	50	0,64	4,35	1,37	4,14	4,10
0,55	SM71BG/305		71				0,71	6,25	1,84	3,96	3,97
0,75	SM80BG/307 PE		80				0,78	7,38	2,48	3,57	3,75
1,1	SM80BG/311 PE		80				0,79	8,31	3,63	3,95	3,95
1,5	SM80BG/315 PE		80				0,80	8,80	4,96	4,31	4,10
2,2	PLM90BG/322 E3		90				0,80	8,77	7,28	3,72	3,70
3	PLM90BG/330 E3		90				0,79	7,81	9,93	4,26	3,94

P _N kW	Voltage U _N V											n _N min ⁻¹	Operating conditions **		
	Δ			Y			Δ			Y			Altitude Above Sea Level (m)	T. amb min/max °C	ATEX
	220 V	230 V	240 V	380 V	400 V	415 V	380 V	400 V	415 V	660 V	690 V				
	I _N (A)														
0,4	2,03	2,18	2,32	1,17	1,26	1,34	-	-	-	-	-	2745 ÷ 2800	≤ 1000	-15 / 40	No
0,55	2,46	2,49	2,56	1,43	1,44	1,48	-	-	-	-	-	2835 ÷ 2865			
0,75	2,96	2,94	2,96	1,71	1,70	1,71	1,70	1,69	1,70	0,98	0,98	2875 ÷ 2895			
1,1	4,19	4,14	4,16	2,42	2,39	2,40	2,41	2,38	2,38	1,39	1,37	2870 ÷ 2900			
1,5	5,56	5,49	5,51	3,21	3,17	3,18	3,21	3,18	3,19	1,85	1,84	2870 ÷ 2895			
2,2	7,97	7,90	7,98	4,60	4,56	4,61	4,57	4,54	4,57	2,64	2,62	2880 ÷ 2900			
3	11,0	11,0	11,2	6,35	6,33	6,44	6,29	6,27	6,34	3,63	3,62	2865 ÷ 2895			

P _N kW	Efficiency η _N																		IE
	Δ 220 V Y 380 V			Δ 230 V Y 400 V			Δ 240 V Y 415 V			Δ 380 V Y 660 V			Δ 400 V Y 690 V			Δ 415 V			
	4/4	3/4	2/4	4/4	3/4	2/4	4/4	3/4	2/4	4/4	3/4	2/4	4/4	3/4	2/4	4/4	3/4	2/4	
0,4	70,4	73,2	68,9	70,4	70,3	64,5	70,4	67,2	60,2	-	-	-	-	-	-	-	-	-	2
0,55	74,1	74,2	70,4	74,1	73,6	68,8	74,1	72,7	67,1	-	-	-	-	-	-	-	-	-	
0,75	82,5	83,1	81,3	82,8	82,7	80,1	82,6	82,0	78,9	82,5	82,0	78,9	82,5	82,0	78,9	82,5	82,0	78,9	3
1,1	84,0	84,7	83,4	84,4	84,5	82,5	84,3	84,0	81,4	84,0	84,0	81,4	84,0	84,0	81,4	84,0	84,0	81,4	
1,5	85,6	86,5	85,8	85,9	86,4	84,9	86,0	86,0	84,0	85,6	86,0	84,0	85,6	86,0	84,0	85,6	86,0	84,0	
2,2	86,5	87,4	86,8	86,4	86,9	85,7	86,6	86,7	85,0	86,4	86,7	85,0	86,4	86,7	85,0	86,4	86,7	85,0	
3	87,2	88,5	88,3	87,5	88,2	87,5	87,5	87,8	86,4	87,2	87,8	86,4	87,2	87,8	86,4	87,2	87,8	86,4	

** Operating conditions to be referred to motor only. About electric pump, refer to limits in user's manual.

cea-IE3-mott-2p50-en_c_te

BOOSTER SETS GX5 AND GMD SERIES CHARACTERISTICS OF BG ELECTRIC PUMPS

PUMP DESIGN

The **BG** are self-priming close-coupled centrifugal pumps with built-in ejector system, designed to remain primed even in the presence of water-dissolved gases. The extensive use of pressed stainless steel ensures a high-performance, durable and lightweight pump. Suitable for use with drinking water.



SPECIFICATIONS PUMP

- Delivery up to **4,2 m³/h**.
- Head up to **53 m**.
- Temperature of pumped liquid: from -10°C to +40°C
- Maximum working **pressure**: 8 bar (PN 8).
- **Maximum total lift**: 8 m.
- Hydraulic performance compliant with ISO 9906:2012 (Grade 3B). (ex ISO 9906:1999 - Annex A).
- Counter-clockwise rotation facing the pump from the suction port.

MOTOR

- Asynchronous, squirrel cage rotor, enclosed construction in aluminum casing, external ventilation.
- **Protection**: IP55.
- Class 155 (F) **insulation**.
- Performances according to EN 60034-1.
- **Standard voltage**:
 - **Single-phase** version:
220-240 V 50 Hz, 2 poles with built-in automatic reset overload protection.
 - **Three-phase** version:
220-240/380-415 V 50 Hz;
overload protection to be provided by the user.

BOOSTER SETS GXS AND GMD SERIES WITH ELECTRIC PUMPS BG HYDRAULIC PERFORMANCE TABLE AT 50 Hz

PUMP TYPE	VERSION	ELECTRIC PUMP			Q = DELIVERY									
		* P1 kW	PN kW	MOTOR TYPE	l/min 0	20	35	50	65	80	95	110	125	140
					m3/h 0	1,2	2,1	3,0	3,9	4,8	5,7	6,6	7,5	8,4
H = TOTAL HEAD IN METRES OF COLUMN OF WATER														
BGM3	1 ~	2 X 0,67	2 X 0,4	SM71BG/1055	38,9	32,5	28,5	25,2	22,1	19,2	16,3			
BGM5		2 X 0,85	2 X 0,75	SM71BG/1075	41,5	37,1	34,2	31,7	29,3	27,0	24,6	22,0		
BGM7		2 X 1,04	2 X 0,8	SM71BG/1075	45,6			36,6	34,2	31,8	29,5	27,3		
BGM11		2 X 1,34	2 X 1,1	SM80BG/1115	52,9			43,9	41,5	39,2	37,0	34,7	32,4	30,0
BG3	3 ~	2 X 0,68	2 X 0,37	SM63BG/304	36,9	30,6	26,8	23,5	20,6	17,7	14,8			
BG5		2 X 0,81	2 X 0,55	SM71BG/305	40,2	35,7	32,9	30,3	28,0	25,7	23,3	20,7		
BG7		2 X 1,02	2 X 0,75	SM80BG/307PE	45,4			36,5	34,0	31,7	29,4	27,1		
BG9		2 X 1,11	2 X 0,9	SM80BG/311PE	49,6			39,4	37,0	34,8	32,8	30,9	29,2	
BG11		2 X 1,3	2 X 1,1	SM80BG/311PE	53,2			44,1	41,8	39,5	37,3	35,0	32,7	30,3

Maximum delivery depends on geodetic suction lift with clean 8 m pipe and 1¼" foot valve.

2p_bg-2p50-en_b_th

Hydraulic performances in compliance with ISO 9906:2012 - Grade 3B (ex ISO 9906:1999 - Annex A)

* Maximum value in specified range: P1 = input power.

The table refers to performance with 2 pumps running.

ELECTRICAL DATA TABLE AT 50 Hz

PUMP TYPE	VERSION	ELECTRIC PUMP			CURRENT ABSORBED
		* P1 kW	PN kW	MOTOR TYPE	GXS 1x(220-240)Vac A
BGM3	1 ~	2 X 0,67	2 X 0,4	SM71BG/1055	5,7
BGM5		2 X 0,85	2 X 0,75	SM71BG/1075	7,6
BGM7		2 X 1,04	2 X 0,8	SM71BG/1075	9,3
BGM11		2 X 1,34	2 X 1,1	SM80BG/1115	11,8
					GMD 3x(380-415)Vac A
BG3	3 ~	2 X 0,68	2 X 0,37	SM63BG/304	3,0
BG5		2 X 0,81	2 X 0,55	SM71BG/305	3,2
BG7		2 X 1,02	2 X 0,75	SM80BG/307PE	3,7
BG9		2 X 1,11	2 X 0,9	SM80BG/311PE	4,4
BG11		2 X 1,3	2 X 1,1	SM80BG/311PE	4,8

The current shown is the nominal current of set

2p_bg-2p50-en_b_te

* Maximum value in specific range: P1 = input power

BOOSTER SETS GX5 AND GMD SERIES WITH ELECTRIC PUMPS BG SINGLE-PHASE MOTORS, 2 POLES AT 50 Hz

P _N kW	MOTOR TYPE	IEC SIZE	Construction Design	INPUT CURRENT I _n (A)		CAPACITOR		DATA FOR 230 V 50 Hz VOLTAGE					Operating conditions *			
				220-240 V	μF	V	min ⁻¹	I _s / I _n	η %	cosφ	T _n Nm	T _s /T _n	T _m /T _n	Altitude A.S.L. m	T. amb min/max °C	ATEX
0,55	SM71BG/1055	71	SPECIAL	3,33-3,19	16	450	2810	4,16	74,1	0,99	1,87	0,69	2,13	1000 VI	-15 / 40	No
0,75	SM80BG/1075	80		4,38-4,27	25	450	2865	5,11	77,4	0,97	2,50	0,40	2,26			
0,8	SM80BG/1085	80		4,71-4,52	25	450	2850	4,79	77,8	0,97	2,68	0,37	2,11			
1,1	SM80BG/1115	80		6,26-5,93	30	450	2860	4,78	79,6	0,98	3,67	0,50	2,14			

* Operating conditions to be referred to motor only. About electric pump, refer to limits in user's manual.

bg-motm_2p50-en_c_te

THREE-PHASE MOTORS, 2 POLES AT 50 Hz

P _N kW	Manufacturer		IEC SIZE	Construction Design	N. of Poles	f _N Hz	Data for 400 V / 50 Hz Voltage				
	Xylem Service Italia Srl Reg. No. 07520560967 Montecchio Maggiore Vicenza - Italia						cosφ	I _s / I _N	T _N Nm	T _s /T _N	T _m /T _N
0,40	SM63BG/304		63	SPECIAL	2	50	0,64	4,35	1,37	4,14	3,13
0,55	SM71BG/305		71				0,74	5,97	1,85	3,74	3,56
0,75	SM80BG/307 PE		80				0,78	7,38	2,48	3,57	3,75
1,1	SM80BG/311 PE		80				0,79	8,31	3,63	3,95	3,95

P _N kW	Voltage U _N V										n _N min ⁻¹	Operating conditions *			
	Δ			Y			Δ			Y		Altitude Above Sea Level (m)	T. amb min/max °C	ATEX	
	220 V	230 V	240 V	380 V	400 V	415 V	380 V	400 V	415 V	660 V					690 V
0,40	2,03	2,18	2,32	1,17	1,26	1,34	-	-	-	-	-	2745 ÷ 2800	≤ 1000	-15 / 40	No
0,55	2,46	2,49	2,56	1,42	1,44	1,48	-	-	-	-	-	2835 ÷ 2865			
0,75	2,96	2,94	2,96	1,71	1,70	1,71	1,70	1,69	1,70	0,98	0,98	2875 ÷ 2895			
1,1	4,19	4,14	4,16	2,42	2,39	2,40	2,41	2,38	2,38	1,39	1,37	2870 ÷ 2900			

P _N kW	Δ 220 V Y 380 V			Δ 230 V Y 400 V			Δ 240 V Y 415 V			Δ 380 V Y 660 V			Δ 400 V Y 690 V			Δ 415 V			IE
	4/4	3/4	2/4	4/4	3/4	2/4	4/4	3/4	2/4	4/4	3/4	2/4	4/4	3/4	2/4	4/4	3/4	2/4	
0,40	70,4	73,2	68,9	70,4	70,3	64,5	70,4	67,2	60,2	-	-	-	-	-	-	-	-	-	2
0,55	74,1	74,2	70,4	74,1	73,6	68,8	74,1	72,7	67,1	-	-	-	-	-	-	-	-	-	2
0,75	82,5	83,1	81,3	82,8	82,7	80,1	82,6	82,0	78,9	82,5	82,0	78,9	82,5	82,0	78,9	82,5	82,0	78,9	3
1,1	84,0	84,7	83,4	84,4	84,5	82,5	84,3	84,0	81,4	84,0	84,0	81,4	84,0	84,0	81,4	84,0	84,0	81,4	3

* Operating conditions to be referred to motor only. About electric pump, refer to limits in user's manual.

bg-IE3-mott-2p50-en_b_te

BOOSTER SETS GX5 AND GMD SERIES CHARACTERISTICS OF e-SV ELECTRIC PUMPS PUMP DESIGN

The **e-SV** pump is a non-self priming vertical multistage pump coupled to a standard motor.

- The liquid end, located between the upper cover and the pump casing, is held in place by tie rods.
- The pump casing is available with different configurations and connection types.
- The following versions are available:
 - **F**: round flanges, in-line delivery and suction ports, AISI 304.
 - **T**: oval flanges, in-line delivery and suction ports, AISI 304.
 - **R**: round flanges, delivery port above the suction port, with four adjustable positions, AISI 304.
 - **N**: round flanges, in-line delivery and suction ports, AISI 316.
 - **V**: Victaulic® couplings, in-line delivery and suction ports, AISI 316.
 - **P**: reinforced sleeve, Victaulic® couplings, in-line delivery and suction ports, AISI 316.
 - **C**: Clamp couplings (DIN 32676), in-line delivery and suction ports, AISI 316.
 - **K**: threaded couplings, (DIN 11851), in-line delivery and suction ports, AISI 316.
- **Balanced mechanical seal** according to EN 12756 (ex DIN 24960) and ISO 3069, which **can be replaced without removing the motor from the pump** for 10, 15 and 22SV (≥ of 5,5 kW) series.



- Seal housing chamber designed to prevent the accumulation of air in the critical area next to the mechanical seal.
- A second plug is available for 10, 15, 22SV series.
- Versions with round flanges that can be coupled to counter-flanges, according to EN 1092.
- Threaded, oval counter-flanges made of stainless steel are standard supply for the T versions.
- Round counter-flanges made of stainless steel are available on request for the F, R and N versions.
- Easy maintenance. No special tools required for assembly or disassembly.

SPECIFICATIONS PUMP

- Delivery: up to **29 m³/h**.
- Head: up to **160 m**.
- Temperature of pumped liquid:
 - from -30°C to +120°C for standard version.
- Maximum operating **pressure**:
 - 1, 3, 5, 10, 15, 22SV with oval flanges: 16 bar (PN16).
 - 1, 3, 5, 10, 15, 22SV with round flanges: 25 bar (PN25).
- Hydraulic performance compliant with ISO 9906:2012
 - Grade 3B (ex ISO 9906:1999 - Annex A).
- Direction of rotation: clockwise looking at the pump from the top down (marked with an arrow on the adapter and on the coupling).

MOTOR

- Squirrel cage in short circuit, enclosed construction with external ventilation.
- IP55 protection.
- Class 155 (F) insulation.
- Performances according to EN 60034-1.
- Standard voltage:
 - Single-phase version: 220-240 V, 50 Hz.
 - Three-phase version: 220-240/380-415 V, 50 Hz for power up to 3 kW, 380-415/660-690 V, 50 Hz for power above 3 kW.
- Supplied **single-phase** surface motors with **IE2** efficiency level
- Supplied **three-phase** surface motors with **IE2** efficiency level (power < 0,75 kW) or **IE3** efficiency level (power ≥ 0,75 kW) as standard according to EN 60034-30:2009 and EN 60034-30-1:2014.

Inlet pressure of the pump plus static pressure of the water within the pump cannot exceed the nominal pressure (PN). Using different motors from those provided could limit inlet pressure. In this event please contact customer services.

The pumps for drinking water use are WRAS, ACS and D.M. 174 certified for F, T, R, N versions.

**BOOSTER SETS GX5 AND GMD SERIES
WITH ELECTRIC PUMPS e-SV
HYDRAULIC PERFORMANCE TABLE AT 50 Hz**

PUMP TYPE	RATED POWER kW	MEI ≥ (1)	Q = DELIVERY										
			l/min 0 m ³ /h 0	24 1,4	40 2,4	50 3,0	60 3,6	70 4,2	80 4,8	90 5,4	100 6,0	120 7,2	146 8,8
H = TOTAL HEAD IN METRES OF COLUMN OF WATER													
3SV02	2 x 0,37	0,70	14,9		14,5	14,3	14,0	13,5	13,0	12,4	11,7	9,8	6,5
3SV03	2 x 0,37	0,70	22,0		21,2	20,8	20,3	19,6	18,7	17,7	16,6	13,7	8,6
3SV04	2 x 0,37	0,70	28,9		27,7	27,1	26,2	25,2	23,9	22,5	20,8	16,8	10,1
3SV05	2 x 0,55	0,70	37,2		36,4	35,8	35,0	33,9	32,6	31,1	29,2	24,5	16,2
3SV06	2 x 0,55	0,70	44,4		43,4	42,6	41,6	40,2	38,6	36,6	34,3	28,5	18,5
3SV07	2 x 0,75	0,70	52,5		51,8	51,0	50,0	48,7	47,0	45,0	42,5	36,1	24,6
3SV08	2 x 0,75	0,70	60,0		59,1	58,2	57,0	55,4	53,4	51,0	48,1	40,7	27,5
3SV09	2 x 1,1	0,70	67,7		66,8	65,8	64,5	62,8	60,6	57,9	54,6	46,4	31,6
3SV10	2 x 1,1	0,70	75,0		73,8	72,7	71,3	69,3	66,9	63,8	60,2	51,0	34,5
3SV11	2 x 1,1	0,70	82,3		81,0	79,7	78,0	75,8	73,1	69,7	65,7	55,5	37,4
3SV12	2 x 1,1	0,70	89,6		87,8	86,4	84,5	82,1	79,1	75,5	71,1	59,9	40,1
3SV13	2 x 1,5	0,70	98,1		96,7	95,4	93,5	91,0	87,8	83,9	79,2	67,2	45,6
3SV14	2 x 1,5	0,70	105,6		104,1	102,5	100,4	97,7	94,2	89,9	84,8	71,8	48,5
3SV16	2 x 1,5	0,70	119,9		117,8	116,1	113,6	110,5	106,5	101,6	95,8	80,9	54,2
3SV19	2 x 2,2	0,70	144,3		142,3	140,3	137,5	133,9	129,2	123,5	116,7	99,1	67,6
3SV21	2 x 2,2	0,70	159,3		156,9	154,6	151,4	147,3	142,1	135,7	128,0	108,5	73,6

Hydraulic performances in compliance with ISO 9906:2012 - Grade 3B (ex ISO 9906:1999 - Annex A)

2p_3sv-2p50-en_a_th

(1) Value referred to the F, T, R, N, V, C, K versions. P version excluded.

The table refers to performance with 2 pumps running.

PUMP TYPE	RATED POWER kW	MEI ≥ (1)	Q = DELIVERY										
			l/min 0 m ³ /h 0	50 3,0	70 4,2	80 4,8	90 5,4	100 6,0	120 7,2	146 8,8	200 12,0	240 14,4	282 16,9
H = TOTAL HEAD IN METRES OF COLUMN OF WATER													
5SV02	2 x 0,37	0,70	14,8			13,8	13,7	13,4	13,0	12,2	10,2	8,2	5,7
5SV03	2 x 0,55	0,70	22,8			21,8	21,6	21,3	20,7	19,7	16,9	14,1	10,3
5SV04	2 x 0,55	0,70	30,0			28,2	27,9	27,5	26,6	25,2	21,2	17,3	12,2
5SV05	2 x 0,75	0,70	38,0			36,4	36,0	35,5	34,5	32,9	28,2	23,5	17,1
5SV06	2 x 1,1	0,70	45,3			43,7	43,3	42,8	41,6	39,6	33,9	28,1	20,3
5SV07	2 x 1,1	0,70	52,7			50,7	50,1	49,5	48,1	45,8	39,1	32,2	23,1
5SV08	2 x 1,1	0,70	60,1			57,6	57,0	56,2	54,6	51,8	44,1	36,2	25,8
5SV09	2 x 1,5	0,70	68,0			65,5	64,8	64,0	62,2	59,3	50,6	41,9	30,2
5SV10	2 x 1,5	0,70	75,5			72,4	71,7	70,8	68,7	65,4	55,7	46,0	33,0
5SV11	2 x 1,5	0,70	82,8			79,3	78,4	77,5	75,2	71,4	60,7	49,9	35,6
5SV12	2 x 2,2	0,70	90,8			88,0	87,0	86,0	83,4	79,3	67,4	55,7	40,5
5SV13	2 x 2,2	0,70	98,3			95,0	94,0	92,8	90,0	85,5	72,6	59,9	43,5
5SV14	2 x 2,2	0,70	105,7			102,0	100,9	99,6	96,6	91,7	77,8	64,0	46,3
5SV15	2 x 2,2	0,70	113,1			109,0	107,8	106,4	103,1	97,8	82,8	68,1	49,1
5SV16	2 x 2,2	0,70	120,5			115,9	114,6	113,1	109,6	103,9	87,8	72,1	51,8
5SV18	2 x 3	0,70	135,8			131,1	129,7	128,0	124,1	117,8	99,9	82,3	59,5
5SV21	2 x 3	0,70	157,9			152,0	150,3	148,3	143,6	136,1	114,9	94,2	67,6

Hydraulic performances in compliance with ISO 9906:2012 - Grade 3B (ex ISO 9906:1999 - Annex A)

2p_5sv-2p50-en_a_th

(1) Value referred to the F, T, R, N, V, C, K versions. P version excluded.

The table refers to performance with 2 pumps running.

**BOOSTER SETS GX5 AND GMD SERIES
 WITH ELECTRIC PUMPS e-SV
 HYDRAULIC PERFORMANCE TABLE AT 50 Hz**

PUMP TYPE	RATED POWER kW	MEI ≥ (1)	Q = DELIVERY										
			l/min 0	166,7	200	266	340	366,7	466	540	700	860	966,7
			m ³ /h 0	10,0	12,0	16,0	20,4	22,0	28,0	32,4	42,0	51,6	58,0
H = TOTAL HEAD IN METRES OF COLUMN OF WATER													
10SV01	2 x 0,75	0,70	11,8	11,2	10,9	9,9	8,3	7,6	4,3				
10SV02	2 x 0,75	0,70	23,6	21,9	21,3	19,6	17,0	15,8	10,0				
10SV03	2 x 1,1	0,70	35,7	33,0	32,1	29,6	25,8	24,1	16,0				
10SV04	2 x 1,5	0,70	47,7	44,2	43,0	39,9	34,8	32,6	21,7				
10SV05	2 x 2,2	0,70	60,0	56,1	54,7	50,9	44,9	42,2	29,0				
10SV06	2 x 2,2	0,70	71,8	66,8	65,0	60,4	53,1	49,8	33,9				
10SV07	2 x 3	0,70	83,6	78,3	76,2	70,8	62,1	58,3	39,8				
10SV08	2 x 3	0,70	95,3	88,9	86,5	80,1	70,2	65,7	44,5				
10SV09	2 x 4	0,70	106,3	100,1	97,5	90,8	80,0	75,1	52,1				
10SV10	2 x 4	0,70	118,0	110,8	107,9	100,3	88,2	82,8	57,2				
10SV11	2 x 4	0,70	129,6	121,3	118,1	109,6	96,3	90,3	62,1				

Hydraulic performances in compliance with ISO 9906:2012 - Grade 3B (ex ISO 9906:1999 - Annex A)

2p_10sv-040-2p50-en_a_th

(1) Value referred to the F, T, R, N, V, C, K versions. P version excluded.

The table refers to performance with 2 pumps running.

**BOOSTER SETS GXS AND GMD SERIES
 WITH ELECTRIC PUMPS e-SV
 ELECTRICAL DATA TABLE AT 50 Hz**

TYPE	PUMP		GXS20 CURRENT ABSORBED 1x(220-240)Vac A	GMD20 CURRENT ABSORBED 3 x 400 V A
	NOMINAL POWER P _N kW			
3SV02	2 x 0,37		2 x (2,34-2,28)	2,5
3SV03	2 x 0,37		2 x (2,34-2,28)	2,5
3SV04	2 x 0,37		2 x (2,34-2,28)	2,5
3SV05	2 x 0,55		2 x (3,33-3,19)	3,0
3SV06	2 x 0,55		2 x (3,33-3,19)	3,0
3SV07	2 x 0,75		2 x (4,38-4,27)	3,4
3SV08	2 x 0,75		2 x (4,38-4,27)	3,4
3SV09	2 x 1,1		2 x (6,26-5,93)	4,8
3SV10	2 x 1,1		2 x (6,26-5,93)	4,8
3SV11	2 x 1,1		2 x (6,26-5,93)	4,8
3SV12	2 x 1,1		2 x (6,26-5,93)	4,8
3SV13	2 x 1,5		2 x (8,81-7,87)	6,3
3SV14	2 x 1,5		2 x (8,81-7,87)	6,3
3SV16	2 x 1,5		2 x (8,81-7,87)	6,3
3SV19	2 x 2,2		-	9,2
3SV21	2 x 2,2		-	9,2
5SV02	2 x 0,37		2 x (2,34-2,28)	2,5
5SV03	2 x 0,55		2 x (3,33-3,19)	3,0
5SV04	2 x 0,55		2 x (3,33-3,19)	3,0
5SV05	2 x 0,75		2 x (4,38-4,27)	3,4
5SV06	2 x 1,1		2 x (6,26-5,93)	4,8
5SV07	2 x 1,1		2 x (6,26-5,93)	4,8
5SV08	2 x 1,1		2 x (6,26-5,93)	4,8
5SV09	2 x 1,5		2 x (8,81-7,87)	6,3
5SV10	2 x 1,5		2 x (8,81-7,87)	6,3
5SV11	2 x 1,5		2 x (8,81-7,87)	6,3
5SV12	2 x 2,2		-	9,2
5SV13	2 x 2,2		-	9,2
5SV14	2 x 2,2		-	9,2
5SV15	2 x 2,2		-	9,2
5SV16	2 x 2,2		-	9,2
5SV18	2 x 3		-	12,7
5SV21	2 x 3		-	12,7
10SV01	2 x 0,75		2 x (4,38-4,27)	3,4
10SV02	2 x 0,75		2 x (4,38-4,27)	3,4
10SV03	2 x 1,1		2 x (6,26-5,93)	4,8
10SV04	2 x 1,5		2 x (8,81-7,87)	6,3
10SV05	2 x 2,2		-	9,2
10SV06	2 x 2,2		-	9,2
10SV07	2 x 3		-	12,7
10SV08	2 x 3		-	12,7
10SV09	2 x 4		-	15,5
10SV10	2 x 4		-	15,5
10SV11	2 x 4		-	15,5

The current shown is the nominal current of the set.

g20v-2p50-en_e_te

BOOSTER SETS GX5 AND GMD SERIES WITH ELECTRIC PUMPS e-SV SINGLE-PHASE MOTORS, 2 POLES AT 50 Hz

P _N kW	MOTOR TYPE	IEC SIZE*	Construction Design	INPUT CURRENT I _n (A) 220-240 V		CAPACITOR		DATA FOR 230 V 50 Hz VOLTAGE						OPERATING CONDITIONS **		
				μF	V	min ⁻¹	Is / I _n	η %	cosφ	T _n Nm	T _s /T _n	T _m /T _n	Altitude asl m	T. amb min/max °C	ATEX	
0,37	SM71RB14/1045 E2	71R	V18/B14	2,52-2,41	16	450	2800	3,24	70,4	0,99	1,36	0,66	1,98	≤1000	-15/45	No
0,55	SM71B14/1055 E2	71		3,33-3,19	16	450	2810	4,16	74,1	0,99	1,87	0,69	2,13			
0,75	SM80B14/1075 E2	80		4,38-4,27	25	450	2865	5,11	77,4	0,97	2,50	0,40	2,26			
1,1	SM80B14/1115 E2	80		6,26-5,93	30	450	2860	4,78	79,6	0,98	3,67	0,50	2,14			
1,5	PLM90B14/1155 E2	90		8,41-7,87	50	450	2890	6,71	81,3	0,97	4,95	0,59	2,78			

* R = Reduced size of motor casing as compared to shaft extension and flange.

1-22sv-motm_2p50-en_d_te

** Operating conditions related only to the motor. For the electric pump refer to the IOM.

BOOSTER SETS GX5 AND GMD SERIES WITH ELECTRIC PUMPS e-SV THREE-PHASE MOTORS, 2 POLES AT 50 Hz

P _N kW	Manufacturer		IEC SIZE*	Construction Design	N. of Poles	f _N Hz	Data for 400 V / 50 Hz Voltage				
	Xylem Service Italia Srl Reg. No. 07520560967 Montecchio Maggiore Vicenza - Italia						cosφ	I _s / I _N	T _N Nm	T _s /T _N	T _m /T _N
	Model										
0,37	SM71RB14/304		71R	V18/B14	2	50	0,64	4,35	1,37	4,14	4,10
0,55	SM71B14/305		71				0,71	6,25	1,84	3,96	3,97
0,75	SM80B14/307 PE		80				0,78	7,38	2,48	3,57	3,75
1,1	SM80B14/311 PE		80				0,79	8,31	3,63	3,95	3,95
1,5	SM90RB14/315 PE		90R				0,80	8,80	4,96	4,31	4,10
2,2	PLM90B14/322 E3		90				0,80	8,77	7,28	3,72	3,70
3	PLM100RB14/330 E3		100R				0,79	7,81	9,93	4,26	3,94
4	PLM112RB14S6/340 E3		112R				0,85	9,13	13,2	3,82	4,32
5,5	PLM132RB5/355 E3		132R				0,85	10,5	18,1	4,74	5,11
7,5	PLM132B5/375 E3		132				0,85	10,2	24,4	3,43	4,76
11	PLM160RB5/3110 E3		160R				0,86	9,89	35,9	3,46	4,59
15	PLM160B5/3150 E3		160				0,88	9,51	48,6	2,73	4,32
18,5	PLM160B5/3185 E3		160				0,88	9,81	59,9	2,81	4,53
22	PLM180RB5/3220 E3		180R				V1/B5			0,85	10,9
				0,85	10,9	71,1				3,26	5,12

P _N kW	Voltage U _N V											n _N min ⁻¹	Operating conditions **		
	Δ			Y			Δ			Y			Altitude Above Sea Level (m)	T. amb min/max °C	ATEX
	220 V	230 V	240 V	380 V	400 V	415 V	380 V	400 V	415 V	660 V	690 V				
	I _N (A)														
0,37	2,03	2,18	2,32	1,17	1,26	1,34	-	-	-	-	-	2745 ÷ 2800	≤ 1000	-15 / 40	No
0,55	2,46	2,49	2,56	1,42	1,44	1,48	-	-	-	-	-	2835 ÷ 2865			
0,75	2,96	2,94	2,96	1,71	1,70	1,71	1,70	1,69	1,70	0,98	0,98	2875 ÷ 2895			
1,1	4,19	4,14	4,16	2,42	2,39	2,40	2,41	2,38	2,38	1,39	1,37	2870 ÷ 2900			
1,5	5,56	5,49	5,51	3,21	3,17	3,18	3,21	3,18	3,19	1,85	1,84	2870 ÷ 2895			
2,2	7,97	7,90	7,98	4,6	4,56	4,61	4,57	4,54	4,57	2,64	2,62	2880 ÷ 2900			
3	11,0	11,0	11,2	6,35	6,33	6,44	6,29	6,27	6,34	3,63	3,62	2865 ÷ 2895			
4	13,6	13,4	13,4	7,87	7,75	7,74	7,80	7,62	7,61	4,50	4,40	2885 ÷ 2910			
5,5	18,1	17,9	18,1	10,4	10,4	10,4	10,6	10,5	10,7	6,10	6,05	2880 ÷ 2910			
7,5	24,8	24,4	24,3	14,3	14,1	14,0	14,4	14,1	14,2	8,32	8,16	2920 ÷ 2935			
11	35,7	35,0	34,9	20,6	20,2	20,2	20,6	20,2	20,2	11,9	11,7	2910 ÷ 2930			
15	47,6	46,1	45,2	27,5	26,6	26,1	27,5	26,6	26,1	15,9	15,3	2940 ÷ 2950			
18,5	58,3	56,7	55,6	33,7	32,7	32,1	34,0	33,0	32,7	19,6	19,0	2940 ÷ 2950			
22	72,9	73,1	73,7	42,1	42,2	42,6	40,9	40,4	40,6	23,6	23,3	2950 ÷ 2960			

P _N kW	Efficiency η _N %																		IE
	Δ 220 V			Δ 230 V			Δ 240 V			Δ 380 V			Δ 400 V			Δ 415 V			
	Y 380 V			Y 400 V			Y 415 V			Y 660 V			Y 690 V						
	4/4	3/4	2/4	4/4	3/4	2/4	4/4	3/4	2/4	4/4	3/4	2/4	4/4	3/4	2/4	4/4	3/4	2/4	
0,37	70,4	73,2	68,9	70,4	70,3	64,5	70,4	67,2	60,2	-	-	-	-	-	-	-	-	-	2
0,55	74,1	74,2	70,4	74,1	73,6	68,8	74,1	72,7	67,1	-	-	-	-	-	-	-	-	-	
0,75	82,5	83,1	81,3	82,8	82,7	80,1	82,6	82,0	78,9	82,5	82,0	78,9	82,5	82,0	78,9	82,5	82,0	78,9	
1,1	84,0	84,7	83,4	84,4	84,5	82,5	84,3	84,0	81,4	84,0	84,0	81,4	84,0	84,0	81,4	84,0	84,0	81,4	
1,5	85,6	86,5	85,8	85,9	86,4	84,9	86,0	86,0	84,0	85,6	86,0	84,0	85,6	86,0	84,0	85,6	86,0	84,0	
2,2	86,5	87,4	86,8	86,4	86,9	85,7	86,6	86,7	85,0	86,4	86,7	85,0	86,4	86,7	85,0	86,4	86,7	85,0	
3	87,2	88,5	88,3	87,5	88,2	87,5	87,5	87,8	86,4	87,2	87,8	86,4	87,2	87,8	86,4	87,2	87,8	86,4	
4	89,1	90,1	89,2	89,1	90,1	89,2	89,1	90,1	89,2	89,1	90,3	90,4	89,6	90,4	89,9	89,6	90,1	89,2	
5,5	89,5	89,6	88,0	89,5	89,6	88,0	89,5	89,6	88,0	89,5	90,3	89,9	89,7	90,0	89,0	89,6	89,6	88,0	
7,5	90,6	90,5	89,0	90,6	90,5	89,0	90,6	90,5	89,0	90,6	91,0	90,2	90,8	90,8	89,6	90,7	90,5	89,0	
11	91,3	92,0	91,1	91,3	92,0	91,1	91,3	92,0	91,1	91,3	92,2	92,2	91,6	92,2	91,7	91,7	92,0	91,1	
15	92,5	92,4	91,2	92,5	92,4	91,2	92,5	92,4	91,2	92,7	93,3	92,9	93,1	93,3	92,7	92,5	92,4	91,2	
18,5	92,6	93,1	92,4	92,6	93,1	92,4	92,6	93,1	92,4	92,6	93,2	93,0	92,9	93,3	92,8	92,9	93,1	92,4	
22	93,0	92,7	91,3	93,0	92,7	91,3	93,0	92,7	91,3	93,0	93,2	92,4	93,1	93,0	91,9	93,0	92,7	91,3	

* R = Reduced size of motor casing as compared to shaft extension and flange.

sv-IE3-mott22-2p50-en_c_te

** Operating conditions to be referred to motor only. About electric pump, refer to limits in user's manual.

BOOSTER SETS GX5 AND GMD SERIES CHARACTERISTICS OF VM ELECTRIC PUMPS

PUMP DESIGN

The VM is a non-self-priming vertical multistage, high pressure centrifugal pump, with threaded inlet and outlet manifolds. The pumps are close-coupled design and are equipped with non-standard Lowara motors.

The VM is equipped with mechanical seal. The VM are highly modular pumps that are fitted with an innovative hydraulic design that secures high efficiency performances and an increased Mean Time Between Failure.

The VM is available in four different sizes; the design is made of a cast iron pump body coupled to an external stainless steel (EN 1.4301/ AISI 304) TIG welded sleeve with the mean of stainless steel tie rods screwed in the aluminum motor flange. The impellers are made in technopolymer.



SPECIFICATIONS

PUMP

- Flow rate: up to **14 m³/h**.
- Head: up to **98 m**.
- Temperature of the pumped liquid: **+90°C** for uses as EN 60335-2-41.
- Maximum operating pressure: **10 bar** (PN 10).
- Connections: Rp threaded for both suction and discharge manifold.
- Hydraulic performances compliant with ISO 9906:2012 - Grade 3B.

MOTOR

The VM are equipped with Lowara designed and manufactured surface motors in accordance with EN standards. The VM series can be equipped as well with Lowara variable speed drivers.

- Electric short-circuit squirrel-cage motor, enclosed construction, air-cooled (TEFC).
- IP 55 protection degree.
- Insulation class 155 (F).
- Performances according to EN 60034-1.
- Standard voltage:
 - Single-phase: 220-240V, 50 Hz.
 - Three-phase: 220-240/380-415V, 50 Hz up to 3 kW.

BOOSTER SETS GX5 AND GMD SERIES WITH ELECTRIC PUMP VM HYDRAULIC PERFORMANCE TABLE AT 50 Hz

PUMP TYPE VM..P	VERSION	ELECTRIC PUMP			Q = DELIVERY							
		* P ₁ kW	P _N kW	MOTOR TYPE	l/min 0 m ³ /h 0	40,0	56,0	72,0	88,0	104,0	120,0	140,0
H = TOTAL HEAD IN METRES OF COLUMN OF WATER												
3VM02	1 ~	2 x 0,49	2 x 0,55	SM71HM../1055 E2	24,1	22,1	21,1	19,7	17,9	15,9	13,6	10,4
3VM03		2 x 0,62	2 x 0,55	SM71HM../1055 E2	35,3	32,5	30,9	28,8	26,2	23,3	20,1	15,6
3VM04		2 x 0,75	2 x 0,55	SM71HM../1055 E2	46,5	42,4	40,1	37,2	33,6	29,7	25,3	19,4
3VM05		2 x 0,94	2 x 0,75	SM80HM../1075 E2	59,1	54,5	51,8	48,3	44,1	39,2	33,8	26,4
3VM06		2 x 1,14	2 x 1,1	SM80HM../1115 E2	71,4	66,2	63,0	58,9	53,9	48,1	41,6	32,7
3VM07		2 x 1,29	2 x 1,1	SM80HM../1115 E2	82,9	76,5	72,8	67,9	62,0	55,1	47,6	37,1
3VM08		2 x 1,43	2 x 1,1	SM80HM../1115 E2	94,3	86,7	82,4	76,6	69,7	61,9	53,2	41,3
3VM02		3 ~	2 x 0,43	2 x 0,3	SM63HM../303	23,2	20,9	19,6	18,1	16,2	14,1	11,9
3VM03	2 x 0,56		2 x 0,4	SM63HM../304	34,5	31,3	29,4	27,2	24,5	21,6	18,4	13,9
3VM04	2 x 0,70		2 x 0,5	SM63HM../305	45,3	40,6	38,0	34,9	31,3	27,3	23,0	17,1
3VM05	2 x 0,90		2 x 0,75	SM80HM../307 E3	59,5	55,0	52,4	49,0	44,8	39,9	34,5	27,1
3VM06	2 x 1,07		2 x 1,1	SM80HM../311 E3	71,8	66,7	63,7	59,7	54,7	48,9	42,5	33,5
3VM07	2 x 1,23		2 x 1,1	SM80HM../311 E3	83,5	77,3	73,7	68,9	63,1	56,3	48,8	38,3
3VM08	2 x 1,41		2 x 1,5	SM80HM../315 E3	95,8	88,9	84,9	79,5	72,9	65,2	56,6	44,6

Hydraulic performances in compliance with ISO 9906:2012 - Grade 3B (ex ISO 9906:1999 - Annex A)

2p_3vm-2p50-en_b_th

* Maximum value in specified range: P₁ = input power.

The table refers to performance with 2 pumps running.

PUMP TYPE VM..P	VERSION	ELECTRIC PUMP			Q = DELIVERY							
		* P ₁ kW	P _N kW	MOTOR TYPE	l/min 0 m ³ /h 0	80,0	106,0	132,0	158,0	184,0	210	240
H = TOTAL HEAD IN METRES OF COLUMN OF WATER												
5VM02	1 ~	2 x 0,58	2 x 0,55	SM71HM../1055 E2	24,4	21,2	19,8	18,3	16,5	14,4	11,7	7,7
5VM03		2 x 0,77	2 x 0,55	SM71HM../1055 E2	36,0	30,4	28,4	26,3	23,8	20,5	16,4	10,4
5VM04		2 x 1,02	2 x 0,75	SM80HM../1075 E2	48,6	41,6	39,2	36,5	33,2	28,9	23,5	15,5
5VM05		2 x 1,27	2 x 1,1	SM80HM../1115 E2	61,0	52,6	49,6	46,3	42,3	37,0	30,2	20,2
5VM06		2 x 1,48	2 x 1,1	SM80HM../1115 E2	72,9	62,3	58,6	54,5	49,5	43,1	34,9	22,9
5VM07		2 x 1,75	2 x 1,5	PLM90HM../1155 E2	85,8	74,4	70,3	65,8	60,2	52,9	43,4	29,4
5VM08		2 x 1,96	2 x 1,5	PLM90HM../1155 E2	97,8	84,3	79,6	74,3	67,8	59,4	48,5	32,6
5VM02		3 ~	2 x 0,52	2 x 0,4	SM63HM../304	24,1	20,4	18,9	17,3	15,5	13,3	10,5
5VM03	2 x 0,72		2 x 0,5	SM63HM../305	35,3	28,9	26,8	24,5	21,9	18,6	14,4	8,4
5VM04	2 x 0,99		2 x 1,1	SM80HM../311 E3	49,3	43,0	40,7	38,2	35,1	30,9	25,6	17,6
5VM05	2 x 1,22		2 x 1,1	SM80HM../311 E3	61,4	53,2	50,3	47,1	43,1	37,9	31,1	21,1
5VM06	2 x 1,45		2 x 1,5	SM80HM../315 E3	73,8	64,1	60,7	56,9	52,1	45,9	37,8	25,8
5VM07	2 x 1,67		2 x 1,5	SM80HM../315 E3	85,8	74,2	70,1	65,6	60,0	52,7	43,2	29,2
5VM08	2 x 1,93		2 x 2,2	PLM90HM../322 E3	98,6	85,9	81,4	76,3	70,0	61,8	51,0	35,0

Hydraulic performances in compliance with ISO 9906:2012 - Grade 3B (ex ISO 9906:1999 - Annex A)

2p_5vm-2p50-en_b_th

* Maximum value in specified range: P₁ = input power.

The table refers to performance with 2 pumps running.

PUMP TYPE VM..P	VERSION	ELECTRIC PUMP			Q = DELIVERY							
		* P ₁ kW	P _N kW	MOTOR TYPE	l/min 0 m ³ /h 0	166,7	216	266	316	366	416	466
H = TOTAL HEAD IN METRES OF COLUMN OF WATER												
10VM02	1 ~	2 x 1,28	2 x 1,1	SM80HM../1115 E2	30,7	27,0	25,4	23,7	21,6	19,1	16,1	12,6
10VM03		2 x 1,81	2 x 1,5	PLM90HM../1155 E2	46,2	41,4	39,3	36,9	34,1	30,8	26,6	21,5
10VM02	3 ~	2 x 1,22	2 x 1,1	SM80HM../311 E3	30,8	27,3	25,8	24,0	22,0	19,5	16,5	13,0
10VM03		2 x 1,74	2 x 1,5	SM80HM../315 E3	46,2	41,4	39,2	36,8	34,0	30,7	26,5	21,4
10VM04		2 x 2,32	2 x 2,2	PLM90HM../322 E3	61,8	55,4	52,6	49,4	45,8	41,3	35,8	29,0
10VM05		2 x 2,91	2 x 3	PLM90HM../330 E3	77,3	69,5	66,0	62,1	57,5	51,9	45,0	36,5
10VM06		2 x 3,43	2 x 3	PLM90HM../330 E3	92,5	82,6	78,3	73,5	67,9	61,1	52,8	42,6

Hydraulic performances in compliance with ISO 9906:2012 - Grade 3B (ex ISO 9906:1999 - Annex A)

2p_10vm-2p50-en_b_th

* Maximum value in specified range: P₁ = input power.

The table refers to performance with 2 pumps running.

**BOOSTER SETS GXS AND GMD SERIES
 WITH ELECTRIC PUMP VM
 ELECTRICAL DATA TABLE AT 50 Hz**

PUMP TYPE HM..P	MOTOR VERSION	NOMINAL POWER P _N	GXS20 CURRENT ABSORBED 1x(220-240)Vac	GMD20 CURRENT ABSORBED 3 x 400 Vac
		kW	A	A
3VM02	1 ~	2 x 0,5	4,4	-
3VM03		2 x 0,5	5,3	-
3VM04		2 x 0,5	6,4	-
3VM05		2 x 0,75	8,3	-
3VM06		2 x 0,95	10,0	-
3VM07		2 x 0,95	11,3	-
3VM08		2 x 1,1	12,7	-
3VM02		3 ~	2 x 0,3	-
3VM03	2 x 0,4		-	2,7
3VM04	2 x 0,5		-	3,1
3VM05	2 x 0,75		-	3,4
3VM06	2 x 1,1		-	4,3
3VM07	2 x 1,1		-	4,6
3VM08	2 x 1,5		-	5,6
PUMP TYPE VM..P	MOTOR VERSION		NOMINAL POWER P _N	GXS20 CURRENT ABSORBED 1x(220-240)Vac
		kW	A	A
5VM02	1 ~	2 x 0,5	5,1	-
5VM03		2 x 0,5	6,6	-
5VM04		2 x 0,75	9,0	-
5VM05		2 x 0,95	11,2	-
5VM06		2 x 1,1	13,1	-
5VM07		2 x 1,5	15,9	-
5VM08		2 x 1,5	17,7	-
5VM02		3 ~	2 x 0,4	-
5VM03	2 x 0,5		-	3,1
5VM04	2 x 1,1		-	4,1
5VM05	2 x 1,1		-	4,6
5VM06	2 x 1,5		-	5,7
5VM07	2 x 1,5		-	6,2
5VM08	2 x 2,2		-	7,8
PUMP TYPE HM..P	MOTOR VERSION		NOMINAL POWER P _N	GXS20 CURRENT ABSORBED 1x(220-240)Vac
		kW	A	A
10VM02	1 ~	2 x 1,1	11,3	-
10VM03		2 x 1,5	16,4	-
10VM02	3 ~	2 x 1,1	-	4,6
10VM03		2 x 1,5	-	6,3
10VM04		2 x 2,2	-	8,7
10VM05		2 x 3	-	11,6
10VM06		2 x 3	-	12,8

The current shown is the nominal current of the set.

GXS-GMD20-VM-P-2p50-en_b_te

BOOSTER SETS GX5 AND GMD SERIES WITH ELECTRIC PUMP VM SINGLE-PHASE MOTORS, 2 POLES AT 50 Hz

P _N kW	MOTOR TYPE	IEC SIZE	Construction Design	INPUT CURRENT I _n (A)		CAPACITOR		DATA FOR 230 V 50 Hz VOLTAGE						OPERATING CONDITIONS **		
				220-240 V		μF	V	min ⁻¹	Is / I _N	η %	cosφ	T _N Nm	T _s /T _N	T _m /T _N	Altitude asl m	T. amb min/max °C
0,55	SM71HM../1055 E2	71	SPECIAL	3,33-3,19	16	450	2810	4,16	74,1	0,99	1,87	0,69	2,13	1000	-15/45	No
0,75	SM80HM../1075 E2	80		4,38-4,27	25	450	2865	5,11	77,4	0,97	2,50	0,40	2,26			
1,1	SM80HM../1115 E2	80		6,26-5,93	30	450	2860	4,78	79,6	0,98	3,67	0,50	2,14			
1,5	PLM90HM../1155 E2	90		8,41-7,87	50	450	2890	6,71	81,3	0,97	4,95	0,59	2,78			

** Operating conditions related only to the motor. For the electric pump refer to the IOM.

1-22hm-motm_2p50-en_c_te

THREE-PHASE MOTORS, 2 POLES AT 50 Hz

P _N kW	Manufacturer		IEC SIZE	Construction Design	N. of Poles	f _N Hz	Data for 400 V / 50 Hz Voltage				
	Xylem Service Italia srl Reg. No. 07520560967 Montecchio Maggiore Vicenza - Italia						cosφ	Is / I _N	T _N Nm	T _s /T _N	T _m /T _N
0,30	SM63HM../303	63	SPECIAL	2	50	0,63	4,20	1,04	4,18	4,12	
0,40	SM63HM../304	63				0,64	4,35	1,37	4,14	4,10	
0,50	SM63HM../305	63				0,69	4,72	1,75	4,08	4,00	
0,55	SM71HM../305	71				0,71	6,25	1,84	3,96	3,97	
0,75	SM80HM../307 E3	80				0,78	7,38	2,48	3,57	3,75	
1,1	SM80HM../311 E3	80				0,79	8,31	3,63	3,95	3,95	
1,5	SM80HM../315 E3	80				0,80	8,80	4,96	4,31	4,10	
2,2	PLM90HM../322 E3	90				0,80	8,77	7,28	3,72	3,70	
3	PLM90HM../330 E3	90				0,79	7,81	9,93	4,26	3,94	

P _N kW	Voltage U _N V										n _N min ⁻¹	Operating conditions **			
	Δ		Y			Δ		Y				Altitude Above Sea Level (m)	T. amb min/max °C	ATEX	
	220 V	230 V	240 V	380 V	400 V	415 V	380 V	400 V	415 V	660 V					690 V
0,30	1,66	1,82	1,96	0,96	1,05	1,13	-	-	-	-	-	2715 ÷ 2775	≤ 1000	-15 / 50	No
0,40	2,03	2,18	2,32	1,17	1,26	1,34	-	-	-	-	-	2745 ÷ 2800			
0,50	2,42	2,51	2,65	1,40	1,45	1,53	-	-	-	-	-	2690 ÷ 2765			
0,55	2,46	2,49	2,56	1,42	1,44	1,48	-	-	-	-	-	2835 ÷ 2865			
0,75	2,96	2,94	2,96	1,71	1,70	1,71	1,70	1,69	1,70	0,98	0,98	2875 ÷ 2895			
1,1	4,19	4,14	4,16	2,42	2,39	2,40	2,41	2,38	2,38	1,39	1,37	2870 ÷ 2900			
1,5	5,56	5,49	5,51	3,21	3,17	3,18	3,21	3,18	3,19	1,85	1,84	2870 ÷ 2895			
2,2	7,97	7,90	7,98	4,60	4,56	4,61	4,57	4,54	4,57	2,64	2,62	2880 ÷ 2900			
3	11,0	11,0	11,2	6,35	6,33	6,44	6,29	6,27	6,34	3,63	3,62	2865 ÷ 2895			

P _N kW	Efficiency η _N %																		IE
	Δ 220 V Y 380 V			Δ 230 V Y 400 V			Δ 240 V Y 415 V			Δ 380 V Y 660 V			Δ 400 V Y 690 V			Δ 415 V			
	4/4	3/4	2/4	4/4	3/4	2/4	4/4	3/4	2/4	4/4	3/4	2/4	4/4	3/4	2/4	4/4	3/4	2/4	
0,30	67,1	69,6	65	67,1	66,5	60,2	67,1	63,3	55,7	-	-	-	-	-	-	-	-	-	2
0,40	70,4	73,2	68,9	70,4	70,3	64,5	70,4	67,2	60,2	-	-	-	-	-	-	-	-	-	
0,50	73	76,1	73,4	73	73,8	69,6	73	71,3	65,7	-	-	-	-	-	-	-	-	-	
0,55	74,1	74,2	70,4	74,1	73,6	68,8	74,1	72,7	67,1	-	-	-	-	-	-	-	-	-	
0,75	82,5	83,1	81,3	82,8	82,7	80,1	82,6	82,0	78,9	82,5	82,0	78,9	82,5	82,0	78,9	82,5	82,0	78,9	3
1,1	84,0	84,7	83,4	84,4	84,5	82,5	84,3	84,0	81,4	84,0	84,0	81,4	84,0	84,0	81,4	84,0	84,0	81,4	
1,5	85,6	86,5	85,8	85,9	86,4	84,9	86,0	86,0	84,0	85,6	86,0	84,0	85,6	86,0	84,0	85,6	86,0	84,0	
2,2	86,5	87,4	86,8	86,4	86,9	85,7	86,6	86,7	85,0	86,4	86,7	85,0	86,4	86,7	85,0	86,4	86,7	85,0	
3	87,2	88,5	88,3	87,5	88,2	87,5	87,5	87,8	86,4	87,2	87,8	86,4	87,2	87,8	86,4	87,2	87,8	86,4	

** Operating conditions to be referred to motor only. About electric pump, refer to limits in user's manual.

1-10VM-ie3-mott-2p50-en_b_te

BOOSTER SETS GXS AND GMD SERIES RANGE

The range of two-pump booster sets includes fixed speed systems available in a variety of material configurations to suit the specific requirements of different applications.

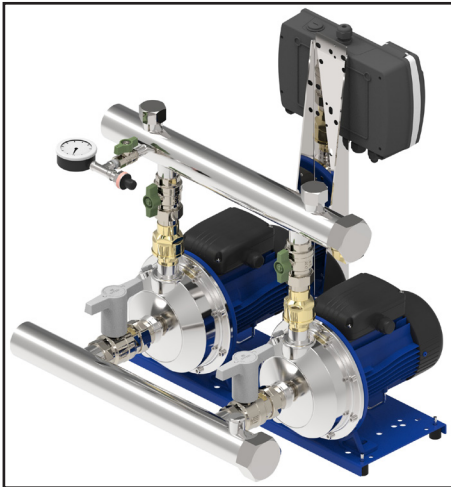

GXS SERIES SETS

- Single-phase power supply, fixed speed and pressure transducer.
For BG, CEA, e-HM, VM, e-SV series electric pumps.

Head up to 141 m.
Flow rate up to 62,4 m³/h.
Power up to 2 x 1,5 kW.

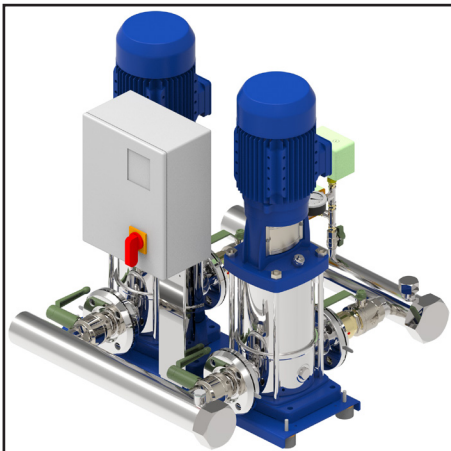

GMD SERIES SETS

- Three-phase power supply, fixed speed and pressure switches control.
For BG, CA, CEA, e-HM and e-SV series electric pumps.

Head up to 160 m.
Flow rate up to 62,4 m³/h.
Power up to 2 x 4 kW.

Booster sets

MARKET SECTORS

CIVIL

APPLICATIONS

- Water network supply in condominiums, offices, hotels, shopping centers, factories.
- Water supply to agricultural water networks (e.g. irrigation).

GXS Series

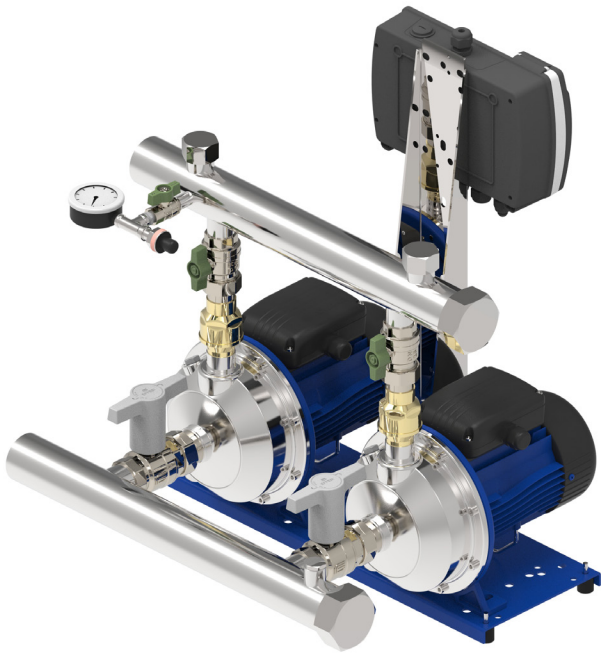

SPECIFICATIONS

- **Flow rate:**
up to 64 m³/h.
- **Head:**
up to 141 m.
- **Electrical panel supply voltage:**
1 x 230V ± 10%.
- **Frequency:**
50 Hz.
- **Protection class electrical panel:**
IP 55.
- **Maximum electric pump power:**
2 x 1,5 kW.
- **Direct motor start.**
- **Maximum temperature of pumped liquid(set):**
 - for e-HM, e-SV, CEA:
from +5 to +60° C, standard version
from +5 to +80° C, A304, B304, C304, A316, B316, C316 versions
 - for BG: from +5 to +40° C
 - for VM: from +5 to +60° C
- **Horizontal design pump**
Maximum operating pressure:
10 bar for e-HM...P
16 bar for e-HM...S
8 bar for BG and CEA
- **Vertical design pump**
Maximum operating pressure:
10 bar for VM
16 bar for e-SV

GXS series booster sets with e-HM, e-SV and VM series pumps are certified for use with drinking water according to WRAS and ACS standards, and with Italian Ministry Decree no. 174.

BOOSTER SETS GX S SERIES IDENTIFICATION CODE

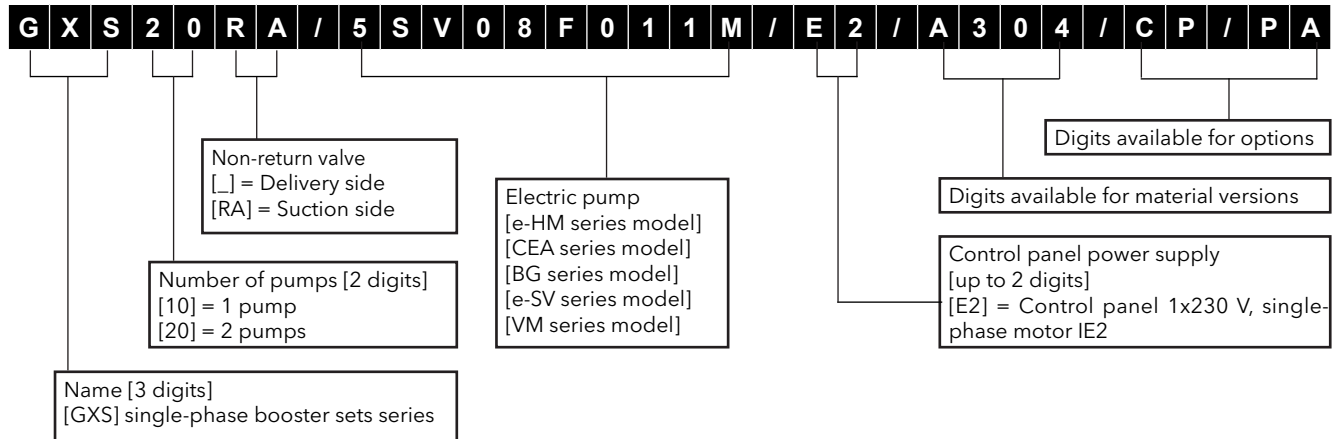

VERSIONS

- A304** Main components in contact with the liquid in AISI 304 stainless steel or higher. Galvanized screws and bolts. Flanges not in contact with the liquid galvanized.
- B304** Main components in contact with the liquid in AISI 304 stainless steel or higher. Screws and bolts in AISI 304 stainless steel or higher. Flanges not in contact with the liquid in AISI 304 stainless steel.
- C304** Main components in contact with the liquid in AISI 304 stainless steel or higher. Base, brackets, supports, screws and bolts in AISI 304 stainless steel or higher. Flanges not in contact with the liquid in AISI 304 stainless steel or higher. Valves fully made of AISI 304 stainless steel or higher (body, heads, disc).
- A316** Main components in contact with the liquid in AISI 316 stainless steel or higher. Galvanized screws and bolts. Flanges not in contact with the liquid galvanized.
- B316** Main components in contact with the liquid in AISI 316 stainless steel. Screws and bolts in AISI 316 stainless steel. Flanges not in contact with the liquid in AISI 316 stainless steel.
- C316** Main components in contact with the liquid in AISI 316 stainless steel. Base, brackets, supports, screws and bolts in AISI 316 stainless steel. Flanges not in contact with the liquid in AISI 316 stainless steel. Valves fully made of AISI 316 stainless steel (body, heads, disc).

OPTIONS

- 3A** Set with 1A certified pumps (Factory test report issued from end of line, QH curve included).
- 3B** Set with 1B certified pumps (Test bulletin issued by Sala Audit (Audit Room); it includes QH curve, output and power).
- BAP** High pressure switch on the delivery manifold.
- CM** Suction or delivery manifold larger than standard size.
- DR1** Set with 1 optical sensor for lack/presence of water.
- CP** Dry contact version: power line, Automatic/Manual mode, Run/Stop for each pump, thermal block.
- IP65** IP65 protection degree control panel.
- PE** Control panel with emergency button.
- PMA** Minimum pressure switch and vacuum pressure gauge for protection against dry running, installed on the suction manifold.
- PQ** Set for aqueduct installation (with pressure gauge/ pressure switches/transmitters oversized by one size).
- RE** Control panel with condensation resistance, controlled by a thermostat.
- SA** Without suction: without suction valves and without suction manifold.
- SC** Set without control devices such as pressure switches and transmitters; with pressure gauge.
- SCA** Without suction manifold (but with suction valves).
- SCM** Without delivery manifold (without pressure switches, transmitters and pressure gauge; with delivery valves).
- SM** Without delivery: without delivery valves and without delivery manifold.
- SQC** Booster set without control panel and bracket; with out pressure transmitter.
- TS** Set with electric pumps with special seals.
- VA** Control panel with digital voltmeter and ammeter.
- WM** Wall mounted control panel; cables L=5m.

BOOSTER SETS GXS SERIES CONTROL PANEL

Q-Smart single-phase electronic control panel, single-phase power input, for controlling and protecting up to two single-phase electric pumps, made of self-extinguishing thermoplastic polymer and protected to IP55.

MAIN CHARACTERISTICS

- Automatic switch with general overload protection and short circuit protection fuses for each motor.
- Standard supply voltage: 1x230Vac +/-10%, 50/60Hz.
- In standard setting, pressure controlled by sensor.
- Inside digital control unit, with microprocessor, offers the following functions:
 - Alphanumeric LED's display (rif. C)
 - Indicator LED's: power on (ref. 9), general fault (rif. 4) and no water level alarm (ref. 6), electric pump running (ref. 1, 3), automatic mode (ref. 2) and manual mode (ref. 5), unit (rif. 7, 8, 10).
- Push buttons (rif. A, B, D, E) to set the unit, control the electric pumps in manual mode, show the alarm log and unit's status. Alarms visualized on display:
 - Maximum, minimum pressure;
 - Short circuit breaker protection for each motor;
 - Pressure transmitter fault.
 - Out-of-curve operation;
 - No water;
 - Maximum/minimum pressure
 - Block for tripped external device (digital input configurable)
- In standard configuration with sensor, pressure is measured and shown.
- Cycle reversal function (can be disabled). Automatically switches pumps after every start/stop cycle.
- Jockey pump management by disabled of cycle reversal function.
- Adjustable electronic thresholds to manage start and stop of each electric pumps. Ready for connection of pressure switches. Automatic switch-on of the pressure switches if the sensor is defective.
- Adjustable timer extending the operation of each electric pumps.
- Dedicated circuit for connection of electrode probes with sensitivity adjustment.
- Adjustable timer delaying tripping the no-water protection system
- Set electronic thresholds for maximum and minimum discharge pressure.
- Recording of operating hours and alarms.
- No-water protection system alternatives: float, minimum pressure switch.
- Connection for maximum pressure switch.
- Connection for external ON/OFF or external alarm.
- Inside card, automatic, manual or exclusion switches for each electric pump. To be used in the event of failure of the electronic board to guarantee the operation of the pumps.
- Connection for 6 relais card (optional) to boost the following

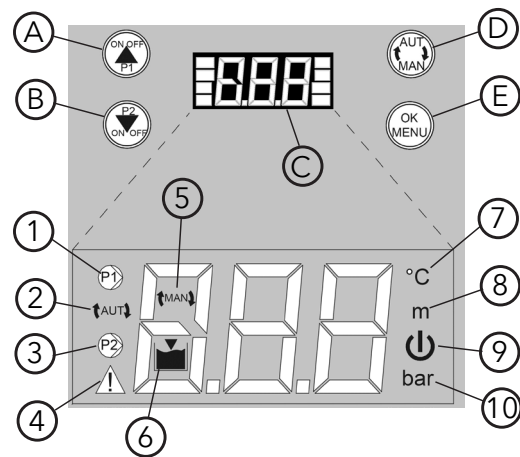

signals:

- Electric pump 1 running,
- Electric pump 2 running,
- Fuse electric pump 1 burned,
- Fuse electric pump 2 burned,
- No water alarm,
- Maximum pressure threshold alarm,
- Minimum pressure threshold alarm,
- External alarm,
- Auto-test faulty,
- Power ON,
- Aut/Man mode.
- Connection ready for ModBus kit RTU 485 (optional).

BOOSTER SETS GX5 SERIES MAIN COMPONENTS

- **Main On-off valves** on suction and discharge side of each pump, ball type with threaded coupling.
- **Check valve** on discharge side of each pump, spring-loaded type
- **Suction manifold** with threaded ends. Threaded coupling for water charging
- **Delivery manifold** with threaded ends. Fitted with two R1" threaded couplings with caps to allow connection of diaphragm pressure vessels.
- **Pressure gauge and control transmitters** located on the delivery side of the unit.
- **Electric control panel**
- **Various couplings** for the connections.
- **Mounting base**, for pump set and panel mounting brackets
- **Anti-vibration dampers** sized depending on the set. In some sets they are provided but not assembled. The installation is the responsibility of the customer.

Version available:

Manifolds, valves, non-return valves and main components with parts directly in contact with the pumped liquid are made of AISI 304 or AISI 316 stainless steel.

.../A304, .../B304, .../C304

.../A316, .../B316, .../C316

Accessories on request:

Devices for protection against dry running in one of the following versions:

- float switch
- pack of electronic module and probe electrodes
- minimum pressure switch

Diaphragm expansion vessel kit Hydrotube with on-off valve, depending on the maximum head of the pump:

- 24 lt, 8 bar hydro tube kit
- 24 lt, 10 bar hydro tube kit
- 24 lt, 16 bar hydro tube kit
- 20 lt, 25 bar hydro tube kit

SPECIAL VERSIONS AVAILABLE ON REQUEST (Contact the Sales and technical Assistance Service)

- Units with special valves.
- Units with stainless steel expansion vessels.

BOOSTER SETS GX5 SERIES TABLE OF MATERIALS

DENOMINATION	G... (STANDARD)	G.../A304	G.../A316
Manifolds	AISI 304	AISI 304	AISI 316
On-off valves	Nickel-plated brass	AISI 316	AISI 316
Non-return valves	Brass	AISI 304	AISI 316
Pressure switches	Galvanized steel/AISI 301	AISI 301	AISI 301
Pressure transmitters	AISI 304	AISI 304	AISI 304
Caps/plugs	AISI 304 / 316	AISI 304 / 316	AISI 316
Sliding/Blind Flanges (not in contact with liquid)	Galvanized steel	Galvanized steel *	Galvanized steel *
Welded flanges (contact with liquid)	AISI 304	AISI 304	AISI 316
Fittings	AISI 316	AISI 316	AISI 316
Bracket	Galvanized steel/painted steel	Galvanized steel/painted steel	Galvanized steel/painted steel
Base	Painted steel	Painted steel	Painted steel

* B304, C304 version in AISI 304; B316, C316 version in AISI 316

g_wad_3-22sv-en_b_tm

BOOSTER SETS GX5 SERIES OPERATING CHARACTERISTICS AND LIMITS

Permitted liquids	Water without gases and corrosive and/or aggressive substances.
Fluid temperature	per e-HM, e-SV, CEA: da +5 a +60° C, standard version. da +5 a +80° C, version A304, B304, C304, A316, B316, C316. per BG: da +5 a +40° C. per VM: da +5 a +60° C.
Ambient temperature	0°C to + 40 °C
Maximum operating pressure*	Max 16 bar
Minimum input pressure	In line with the NPSH curve and the losses, with a margin of at least 0,5 m
Maximum input pressure	The input pressure added to the pump pressure without flow must be lower than the maximum operating pressure of the set.
Installation	Internal environment protected from atmospheric agents. Away from heat sources. Max altitude 1000 a.s.l. Max humidity 50%, without condensation.

* Higher PN available on request depending on pump type

GX_2p-en_a_ti

**BOOSTER SETS GXS SERIES
HM..P HORIZONTAL ELECTRIC PUMPS
DIMENSIONAL TABLE**

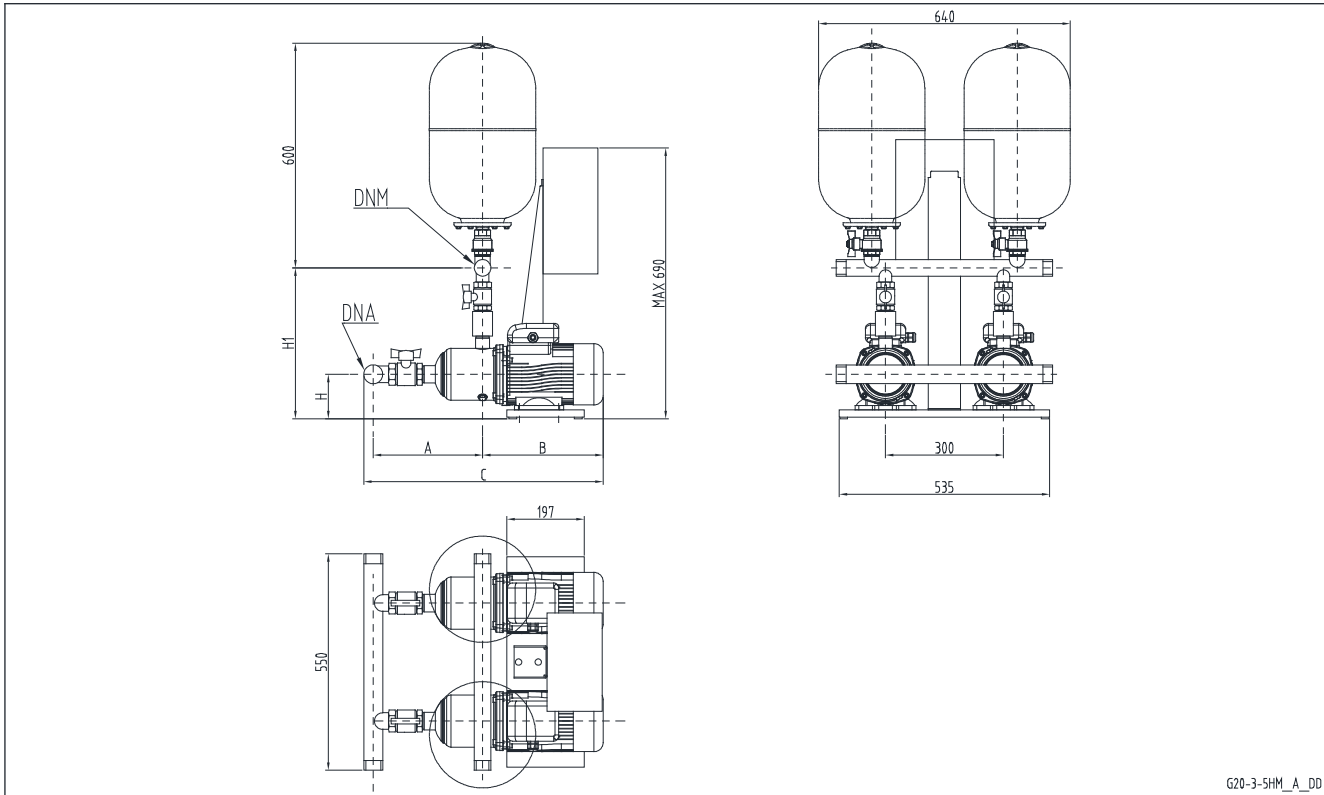

G20-3-5HM_A_DD

GXS 20	DNA	DNM	A	B	C	H	H1
3HM02	R 2"	R 2"	224	263	517	113	398
3HM03	R 2"	R 2"	224	263	517	113	398
3HM04	R 2"	R 2"	244	263	537	113	398
3HM05	R 2"	R 2"	264	308	602	113	398
3HM06	R 2"	R 2"	284	308	622	113	398
5HM02	R 2"	R 2"	245	263	538	113	398
5HM03	R 2"	R 2"	245	263	538	113	398
5HM04	R 2"	R 2"	265	308	603	113	398
5HM05	R 2"	R 2"	285	308	623	113	398
5HM06	R 2"	R 2"	305	308	643	113	398

Dimensions in mm. Tolerance ± 10 mm.

gxs20_3-5hm_c_td

**BOOSTER SETS GXS SERIES
HM..P HORIZONTAL ELECTRIC PUMPS
DIMENSIONAL TABLE**

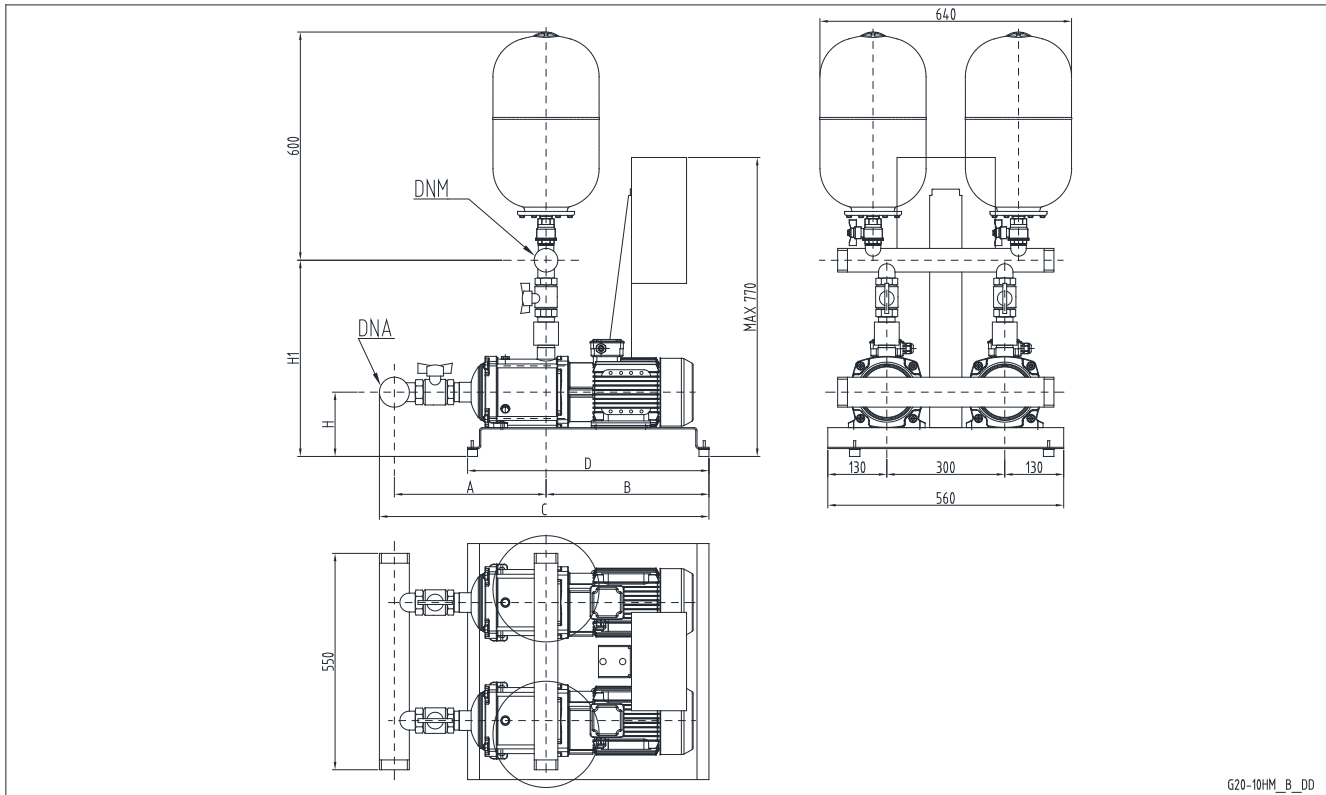

GXS 20	DNA	DNM	A	B	C	D	H	H1
10HM02	R 2"1/2	R 2"1/2	302	354	694	590	205	547
10HM03	R 2"1/2	R 2"1/2	302	354	694	590	205	547

Dimensions in mm. Tolerance ± 10 mm.

gxs20_10hm_c_td

**BOOSTER SETS GX S SERIES
HM..S HORIZONTAL ELECTRIC PUMPS
DIMENSIONAL TABLE**

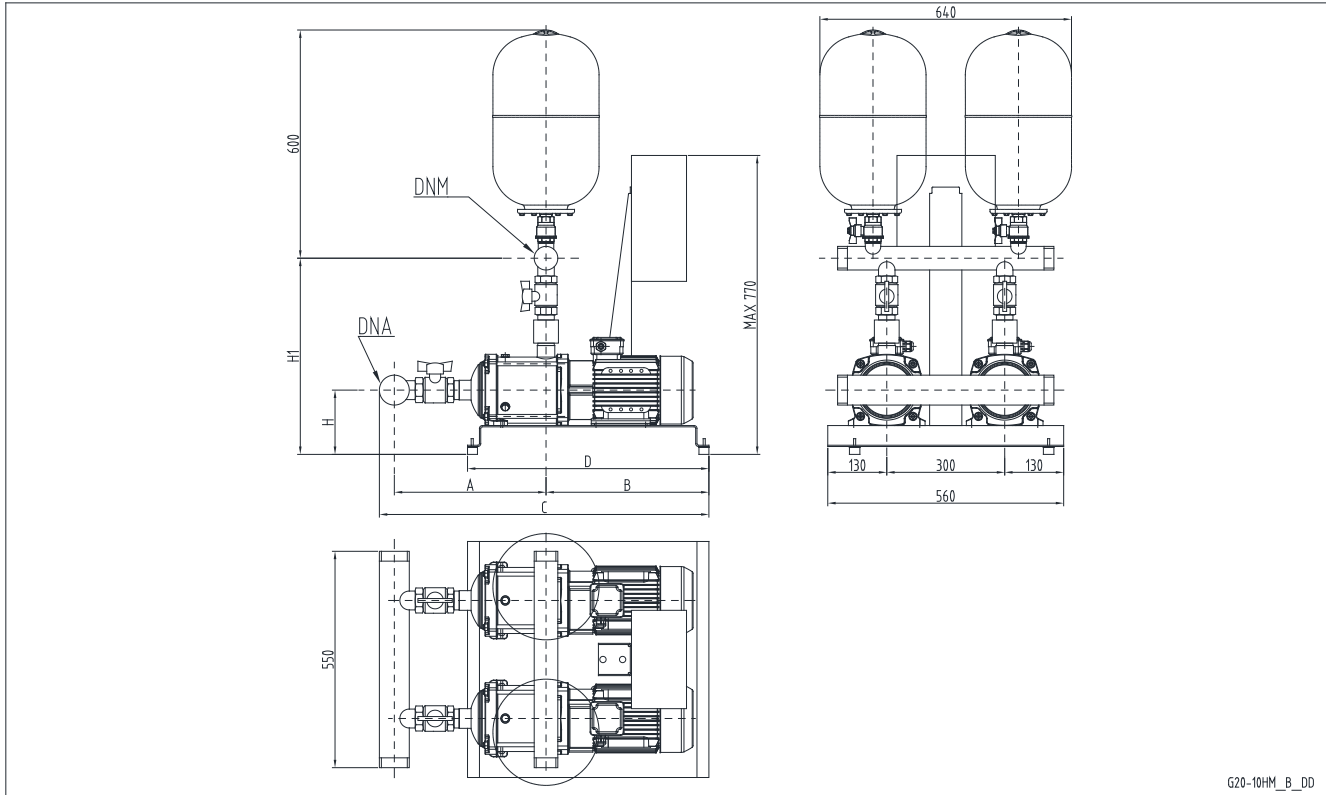

G20-10HM_B_DD

GXS 20	DNA	DNM	A	B	C	D	H	H1
3HM10	R 2"	R 2"	348	354	732	590	205	490
3HM11	R 2"	R 2"	368	354	671	590	205	490
3HM12	R 2"	R 2"	388	354	691	590	205	490
3HM13	R 2"	R 2"	408	354	755	762	205	490
3HM14	R 2"	R 2"	428	354	775	762	205	490
3HM16	R 2"	R 2"	468	354	815	762	205	490
3HM17	R 2"	R 2"	488	354	835	762	205	490
3HM19	R 2"	R 2"	528	377	875	762	205	490
5HM09	R 2"	R 2"	389	354	736	590	205	490
5HM10	R 2"	R 2"	414	354	817	762	205	490
5HM11	R 2"	R 2"	439	354	842	762	205	490
5HM12	R 2"	R 2"	464	390	867	762	205	490

Dimensions in mm. Tolerance ± 10 mm.

gxs20_3-5hms_c_td

**BOOSTER SETS GX S SERIES
BG / CEA HORIZONTAL ELECTRIC PUMPS
DIMENSIONAL TABLE**

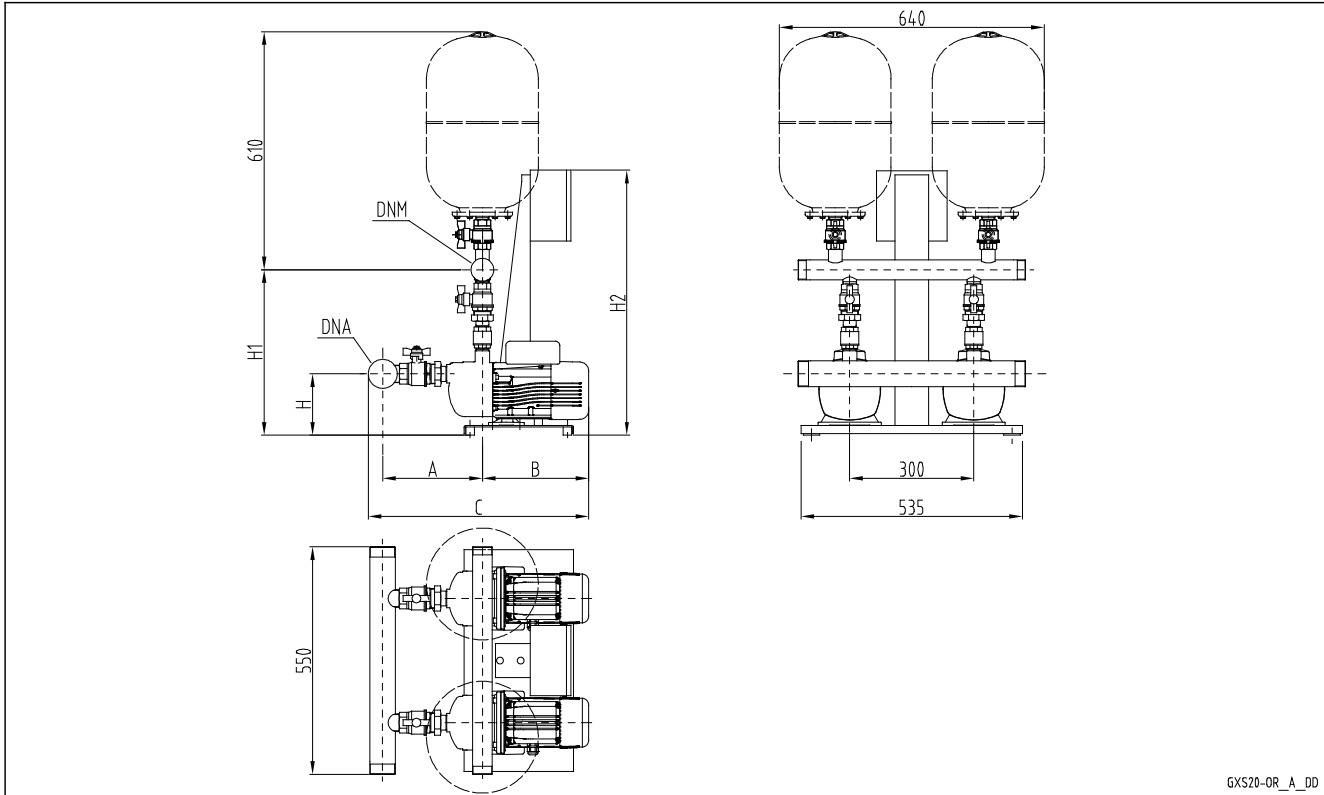

GXS20-OR_A_DD

GXS 20	DNA	DNM	A	B	C	H	H1	H2
BGM3	R 2"	R 1 1/2"	225	311	566	189	431	640
BGM5	R 2"	R 1 1/2"	225	356	611	189	431	640
BGM7	R 2"	R 1 1/2"	225	356	611	189	431	640
BGM11	R 2"	R 1 1/2"	225	356	611	189	431	640
CEAM70/3	R 2"	R 1 1/2"	207	260	497	134	429	640
CEAM70/5	R 2"	R 1 1/2"	207	320	557	134	429	640
CEAM80/5	R 2"	R 1 1/2"	207	320	557	134	429	640
CEAM120/3	R 2"	R 2"	207	274	511	134	453	640
CEAM120/5	R 2"	R 2"	220	320	570	134	453	640
CEAM210/2	R 2 1/2"	R 2 1/2"	231	331	600	134	493	640
CEAM210/3	R 2 1/2"	R 2 1/2"	231	331	600	134	493	640
CEAM210/4	R 2 1/2"	R 2 1/2"	231	379	648	134	493	640
CEAM370/1	R 3"	R 2 1/2"	272	331	647	134	578	640
CEAM370/2	R 3"	R 2 1/2"	272	331	647	134	578	640

Dimensions in mm. Tolerance ± 10 mm.

gxs20_or_i_td

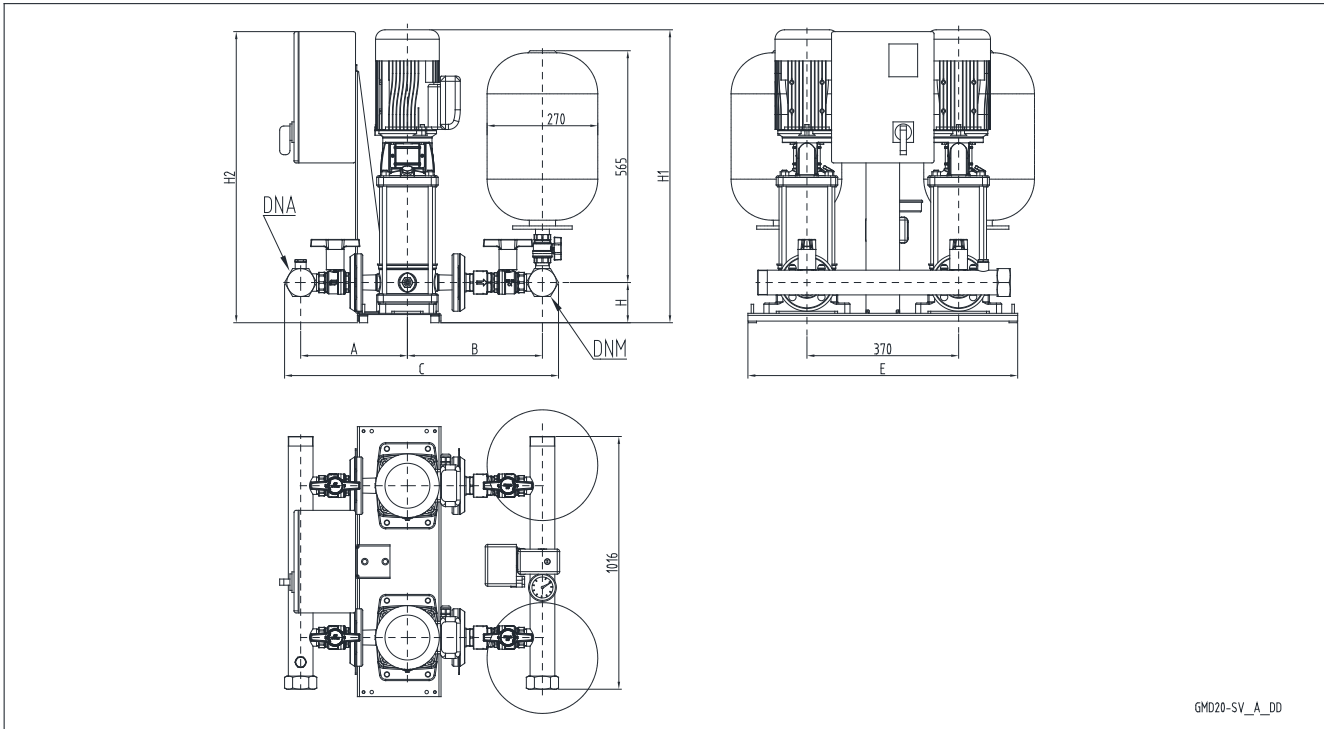
**BOOSTER SETS GX S SERIES
e-SV VERTICAL ELECTRIC PUMPS
DIMENSIONAL TABLE**

GXS 20	DNA	DNM	A	B	C	E	H	H1	H2
3SV02F003M	R 2"	R 2"	256	311	627	658	98	510	629
3SV03F003M	R 2"	R 2"	256	311	627	658	98	510	629
3SV04F003M	R 2"	R 2"	256	311	627	658	98	530	629
3SV05F005M	R 2"	R 2"	256	311	627	658	98	572	629
3SV06F005M	R 2"	R 2"	256	311	627	658	98	592	629
3SV07F007M	R 2"	R 2"	256	311	627	658	98	654	629
3SV08F007M	R 2"	R 2"	256	311	627	658	98	674	629
3SV09F011M	R 2"	R 2"	256	311	627	658	98	694	629
3SV10F011M	R 2"	R 2"	256	311	627	658	98	714	629
3SV11F011M	R 2"	R 2"	256	311	627	658	98	734	629
3SV12F011M	R 2"	R 2"	256	311	627	658	98	754	629
3SV13F015M	R 2"	R 2"	256	311	627	658	98	784	629
3SV14F015M	R 2"	R 2"	256	311	627	658	98	804	629
3SV16F015M	R 2"	R 2"	256	311	627	658	98	844	629
5SV02F003M	R 2"	R 2"	260	329	649	658	98	500	629
5SV03F005M	R 2"	R 2"	260	329	649	658	98	547	629
5SV04F005M	R 2"	R 2"	260	329	649	658	98	572	629
5SV05F007M	R 2"	R 2"	260	329	649	658	98	639	629
5SV06F011M	R 2"	R 2"	260	329	649	658	98	664	629
5SV07F011M	R 2"	R 2"	260	329	649	658	98	689	629
5SV08F011M	R 2"	R 2"	260	329	649	658	98	714	629
5SV09F015M	R 2"	R 2"	260	329	649	658	98	749	629
5SV10F015M	R 2"	R 2"	260	329	649	658	98	774	629
5SV11F015M	R 2"	R 2"	260	329	649	658	98	799	629
10SV01F007M	R 2 1/2"	R 2 1/2"	294	356	726	682	114	654	640
10SV02F007M	R 2 1/2"	R 2 1/2"	294	356	726	682	114	654	640
10SV03F011M	R 2 1/2"	R 2 1/2"	294	356	726	682	114	686	640
10SV04F015M	R 2 1/2"	R 2 1/2"	294	356	726	682	114	728	640

 Dimensions in mm. Tolerance ± 10 mm.

gxs20_eshv-f_c_td

BOOSTER SETS GX S SERIES VM VERTICAL ELECTRIC PUMPS DIMENSIONAL TABLE

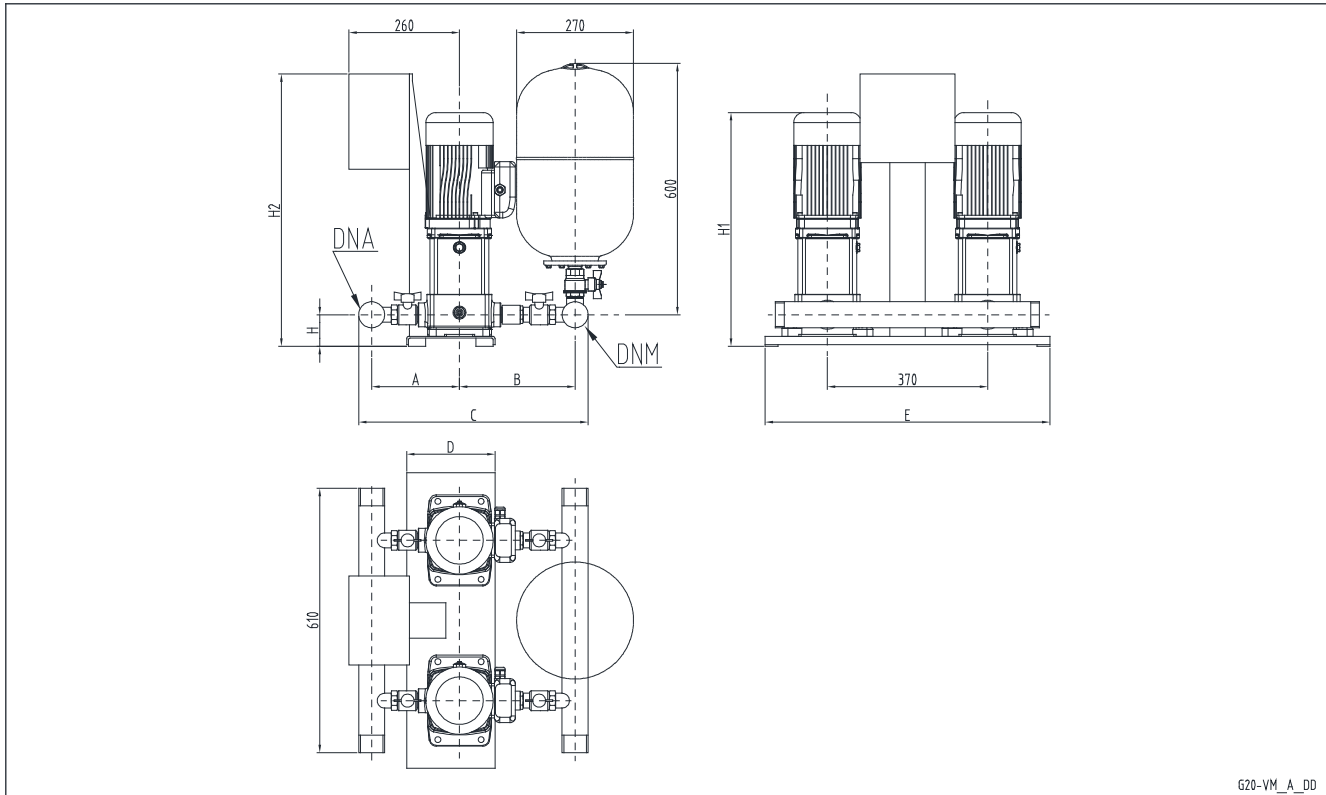

620-VM_A_DD

GX S 20	DNA	DNM	A		B		C		D	E	H	H1	H2
			STD	AISI	STD	AISI	STD	AISI					
3VM02	R2"	R2"	232	314	287	419	579	793	204	658	73	402	629
3VM03	R2"	R2"	232	314	287	419	579	793	204	658	73	402	629
3VM04	R2"	R2"	232	314	287	419	579	793	204	658	73	422	629
3VM05	R2"	R2"	232	314	287	419	579	793	204	658	73	456	629
3VM06	R2"	R2"	232	314	287	419	579	793	204	658	73	476	629
3VM07	R2"	R2"	232	314	287	419	579	793	204	658	73	496	629
3VM08	R2"	R2"	232	314	287	419	579	793	204	658	73	560	629
5VM02	R2"	R2"	251	329	320	449	631	838	204	658	73	402	629
5VM03	R2"	R2"	251	329	320	449	631	838	204	658	73	402	629
5VM04	R2"	R2"	251	329	320	449	631	838	204	658	73	436	629
5VM05	R2"	R2"	251	329	320	449	631	838	204	658	73	456	629
5VM06	R2"	R2"	251	329	320	449	631	838	204	658	73	520	629
5VM07	R2"	R2"	251	329	320	449	631	838	204	658	73	540	629
5VM08	R2"	R2"	251	329	320	449	631	838	204	658	73	560	629
10VM02	R2"1/2	R2"1/2	287	374	354	517	717	967	235	682	114	535	640
10VM03	R2"1/2	R2"1/2	287	374	354	517	717	967	235	682	114	567	640

Dimensioni in mm. Tolleranza ± 10 mm.

gxs20_vm_c_td

Booster sets

MARKET SECTORS

CIVIL

APPLICATIONS

- Water network supply in condominiums, offices, hotels, shopping centers, factories.
- Water supply to agricultural water networks (e.g. irrigation).

GMD Series

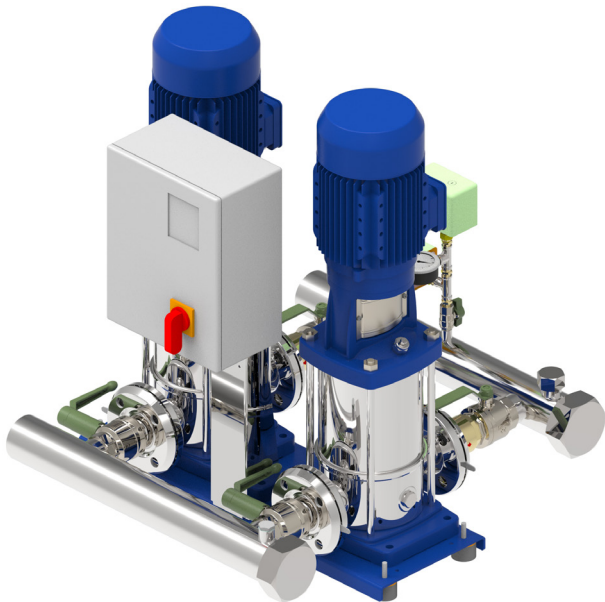

SPECIFICATIONS

- **Flow rate:**
up to 64 m³/h.
- **Head:**
up to 160 m.
- **Electrical panel supply voltage:**
3 x 400V ± 10%.
- **Frequency:**
50 Hz.
- **Protection class electrical panel:**
IP 54.
- **Maximum electric pump power:**
2 x 4 kW.
- **Direct motor start.**
- **Maximum temperature of pumped liquid(set):**
 - for e-HM, e-SV, CEA, VM:
from +5 to +60° C, standard version
from +5 to +80° C, A304, B304, C304, A316, B316, C316 versions
 - for BG: from +5 to +40° C
- **Horizontal design pump**
Maximum operating pressure:
10 bar for e-HM...P
16 bar for e-HM...S
8 bar for BG and CEA
- **Vertical design pump**
Maximum operating pressure:
10 bar for VM
16 bar for e-SV

GXS series booster sets with e-HM, e-SV and VM series pumps are certified for use with drinking water according to WRAS and ACS standards, and with Italian Ministry Decree no. 174.

BOOSTER SETS GMD SERIES IDENTIFICATION CODE

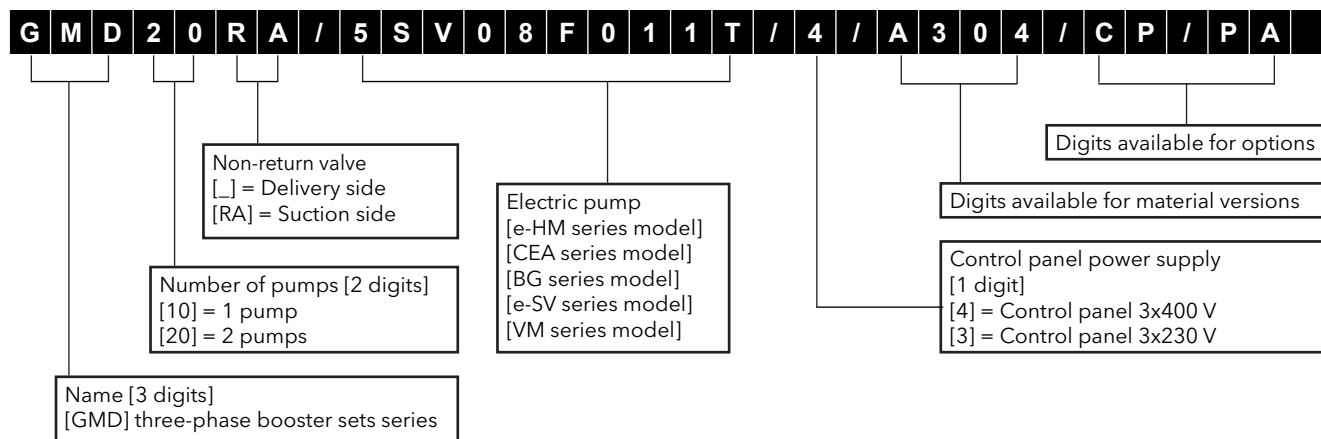

VERSIONS

- A304 Main components in contact with the liquid in AISI 304 stainless steel or higher. Galvanized screws and bolts. Flanges not in contact with the liquid galvanized.
- B304 Main components in contact with the liquid in AISI 304 stainless steel or higher. Screws and bolts in AISI 304 stainless steel or higher. Flanges not in contact with the liquid in AISI 304 stainless steel.
- C304 Main components in contact with the liquid in AISI 304 stainless steel or higher. Base, brackets, supports, screws and bolts in AISI 304 stainless steel or higher. Flanges not in contact with the liquid in AISI 304 stainless steel or higher. Valves fully made of AISI 304 stainless steel or higher (body, heads, disc).
- A316 Main components in contact with the liquid in AISI 316 stainless steel or higher. Galvanized screws and bolts. Flanges not in contact with the liquid galvanized.
- B316 Main components in contact with the liquid in AISI 316 stainless steel. Screws and bolts in AISI 316 stainless steel. Flanges not in contact with the liquid in AISI 316 stainless steel.
- C316 Main components in contact with the liquid in AISI 316 stainless steel. Base, brackets, supports, screws and bolts in AISI 316 stainless steel. Flanges not in contact with the liquid in AISI 316 stainless steel. Valves fully made of AISI 316 stainless steel (body, heads, disc).

OPTIONS

- 3A Set with 1A certified pumps (Factory test report issued from end of line, QH curve included).
- 3B Set with 1B certified pumps (Test bulletin issued by Sala Audit (Audit Room); it includes QH curve, output and power).
- 60 Booster sets frequency of functioning 60 Hz, electric pump with 60 Hz motor.
- BAP High pressure switch on the delivery manifold.
- CM Suction or delivery manifold larger than standard size.
- DR1 Set with 1 optical sensor for lack/presence of water.
- CP Dry contact version: power line, Automatic/Manual mode, Run/Stop for each pump, thermal block.
- IP65 IP65 protection degree control panel.
- PE Control panel with emergency button.
- PMA Minimum pressure switch and vacuum pressure gauge for protection against dry running, installed on the suction manifold.
- PQ Set for aqueduct installation (with pressure gauge/ pressure switches/transmitters oversized by one size).
- RE Control panel with condensation resistance, controlled by a thermostat.
- RV Control panel with phase missing, phase asymmetry and minimum and maximum voltage value control.
- SA Without suction: without suction valves and without suction manifold.
- SC Set without control devices such as pressure switches and transmitters; with pressure gauge.
- SCA Without suction manifold (but with suction valves).
- SCM Without delivery manifold (without pressure switches, transmitters and pressure gauge; with delivery valves).
- SM Without delivery: without delivery valves and without delivery manifold.
- SQC Booster set without control panel and bracket; with out pressure transmitter.
- TS Set with electric pumps with special seals.
- VA Control panel with digital voltmeter and ammeter.
- WM Wall mounted control panel; cables L=5m.

BOOSTER SETS GMD SERIES CONTROL PANEL



Electric panel, three-phase power supply, for controlling and protecting up to two three-phase electric pumps, with case made from sheet steel and protected to IP54.

MAIN CHARACTERISTICS

- Main door-lock switch, fuse holders and fuses, starting contactors and thermal protection such as overload protectors for each motor.
- Standard supply voltage: 3x400Vac +/-10%, 50/60 Hz. Non standard voltages on request, 3x230Vac +/-10%, 3x440Vac +/-10%, 3x460Vac +/-10%, 3x480Vac +/-10%, 50/60 Hz.
- Transformer for low voltage auxiliary circuit; auxiliary voltage 24 Vac.
- Lowara SM20 digital control unit, offers the following functions:
 - Indicator LED's: power on (ref. 1), thermal protection cut-in (ref. 2), no-water level alarm (ref. 3), pump running (ref. 4).
 - Automatic / manual operation buttons (ref. 5) and indicator LED's (ref. 6).
 - Manual pump stop/start (one button for each pump) (ref. 7).
 - Automatic cascade pump control with two pressure switches (one for each pump).
 - Jockey pump management by disabling cycle reversal.
 - Cycle reversal function (can be disabled). Automatically switches pumps after every start/stop cycle.
 - Automatic, manual or disabled mode switches for each pump (inside board). Only to be used if a board fault develops in order to assure pump operation.
 - No-water protection system alternatives: float, minimum pressure switch, external contact or electrode probes with sensitivity adjustment.
 - Adjustable timer delaying tripping of the no-water protection system (inside board); can be adjusted from 0 to 30 seconds.
 - Adjustable timer extending the operation of each pump (inside board); can be adjusted from 0 to 100 sec.
 - A relay board (optional) can be installed on the board to boost the following signals: pump 1,2 running, manual mode, overload alarm, no-water alarm, power on.
- External enable connection or pressure switch for maximum pressure protection.

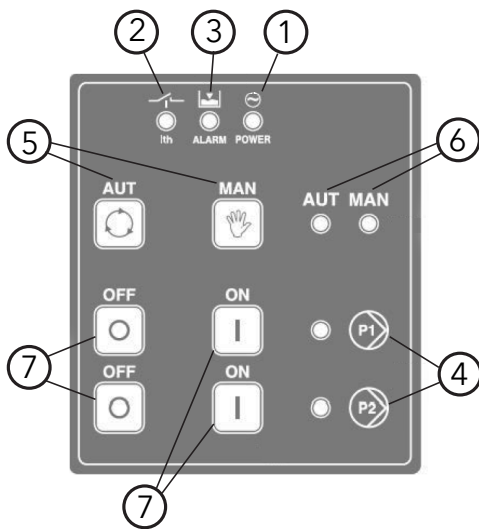

BOOSTER SETS GMD SERIES MAIN COMPONENTS

- **Main On-off valves** on suction and discharge side of each pump, ball type with threaded coupling.
- **Check valve** on discharge side of each pump, spring-loaded type
- **Suction manifold** with threaded ends. Threaded coupling for water charging
- **Delivery manifold** with threaded ends. Fitted with two R1" threaded couplings with caps to allow connection of diaphragm pressure vessels.
- **Pressure gauge and control transmitters** located on the delivery side of the unit.
- **Electric control panel**
- **Various couplings** for the connections.
- **Mounting base**, for pump set and panel mounting brackets
- **Anti-vibration dampers** sized depending on the set. In some sets they are provided but not assembled. The installation is the responsibility of the customer.

Version available:

Manifolds, valves, non-return valves and main components with parts directly in contact with the pumped liquid are made of AISI 304 or AISI 316 stainless steel.

.../A304, .../B304, .../C304

.../A316, .../B316, .../C316

Accessories on request:

Devices for protection against dry running in one of the following versions:

- float switch
- pack of electronic module and probe electrodes
- minimum pressure switch

Diaphragm expansion vessel kit Hydrotube with on-off valve, depending on the maximum head of the pump:

- 24 lt, 8 bar hydro tube kit
- 24 lt, 10 bar hydro tube kit
- 24 lt, 16 bar hydro tube kit
- 20 lt, 25 bar hydro tube kit

SPECIAL VERSIONS AVAILABLE ON REQUEST (Contact the Sales and technical Assistance Service)

- Units with special valves.
- Units with stainless steel expansion vessels.

BOOSTER SETS GMD SERIES TABLE OF MATERIALS

DENOMINATION	G... (STANDARD)	G.../A304	G.../A316
Manifolds	AISI 304	AISI 304	AISI 316
On-off valves	Nickel-plated brass	AISI 316	AISI 316
Non-return valves	Brass	AISI 304	AISI 316
Pressure switches	Galvanized steel/AISI 301	AISI 301	AISI 301
Pressure transmitters	AISI 304	AISI 304	AISI 304
Caps/plugs	AISI 304 / 316	AISI 304 / 316	AISI 316
Sliding/Blind Flanges (not in contact with liquid)	Galvanized steel	Galvanized steel *	Galvanized steel *
Welded flanges (contact with liquid)	AISI 304	AISI 304	AISI 316
Fittings	AISI 316	AISI 316	AISI 316
Bracket	Galvanized steel/painted steel	Galvanized steel/painted steel	Galvanized steel/painted steel
Base	Painted steel	Painted steel	Painted steel

* B304, C304 version in AISI 304; B316, C316 version in AISI 316

g_wad_3-22sv-en_b_tm

BOOSTER SETS GMD SERIES OPERATING CHARACTERISTICS AND LIMITS

Permitted liquids	Water without gases and corrosive and/or aggressive substances.
Fluid temperature	per e-HM, e-SV, CEA, VM: da +5 a +60° C, standard version. da +5 a +80° C, version A304, B304, C304, A316, B316, C316. per BG: da +5 a +40° C.
Ambient temperature	0°C to + 40 °C
Maximum operating pressure*	Max 16 bar
Minimum input pressure	In line with the NPSH curve and the losses, with a margin of at least 0,5 m
Maximum input pressure	The input pressure added to the pump pressure without flow must be lower than the maximum operating pressure of the set.
Installation	Internal environment protected from atmospheric agents. Away from heat sources. Max altitude 1000 a.s.l. Max humidity 50%, without condensation.

* Higher PN available on request depending on pump type

GM_2p-en_a_ti

**BOOSTER SETS GMD SERIES
HM..P HORIZONTAL ELECTRIC PUMPS
DIMENSIONAL TABLE**

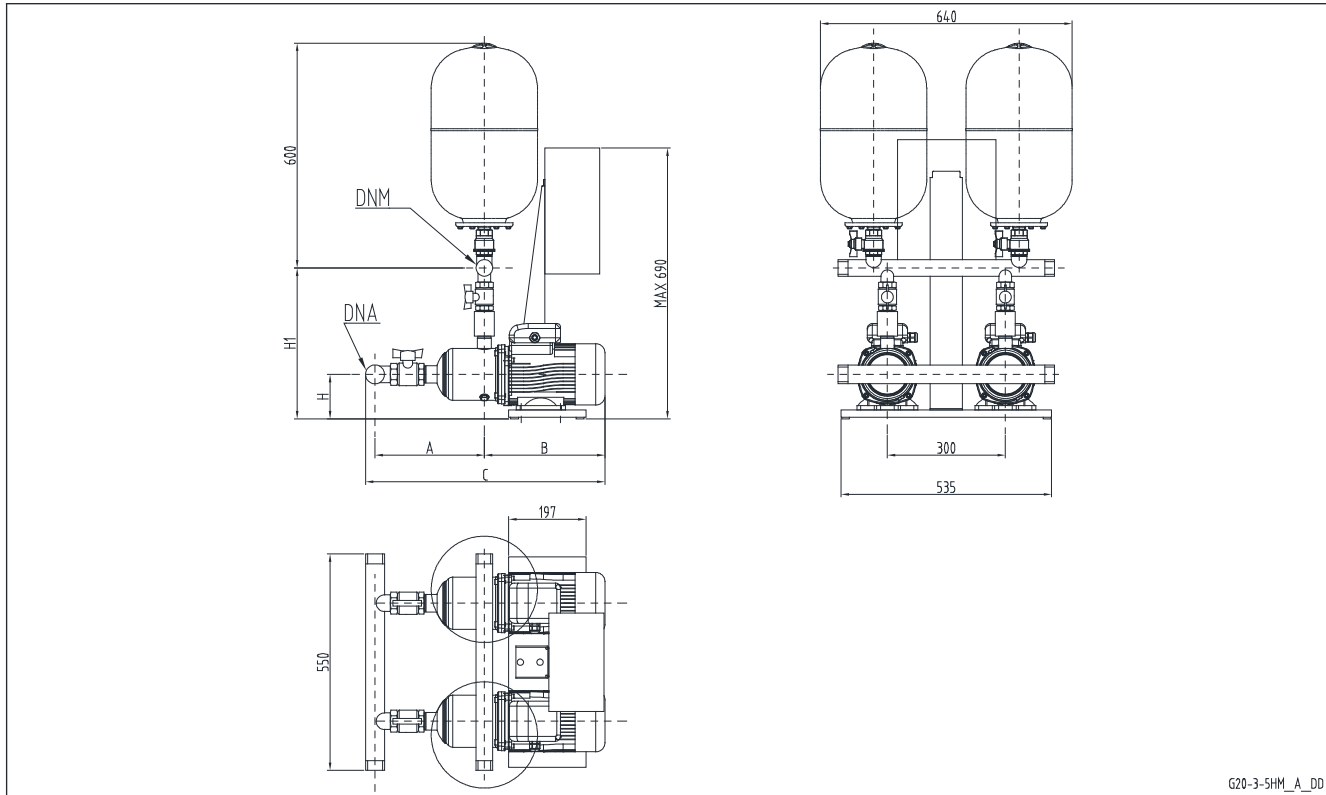

GMD 20	DNA	DNM	A	B	C	H	H1
3HM02	R 2"	R 2"	224	249	503	113	398
3HM03	R 2"	R 2"	224	249	503	113	398
3HM04	R 2"	R 2"	244	249	523	113	398
3HM05	R 2"	R 2"	264	308	602	113	398
3HM06	R 2"	R 2"	284	308	622	113	398
5HM02	R 2"	R 2"	245	249	524	113	398
5HM03	R 2"	R 2"	245	249	524	113	398
5HM04	R 2"	R 2"	265	308	603	113	398
5HM05	R 2"	R 2"	285	308	623	113	398
5HM06	R 2"	R 2"	305	308	643	113	398

Dimensions in mm. Tolerance ± 10 mm.

gmd20_3-5hm_c_td

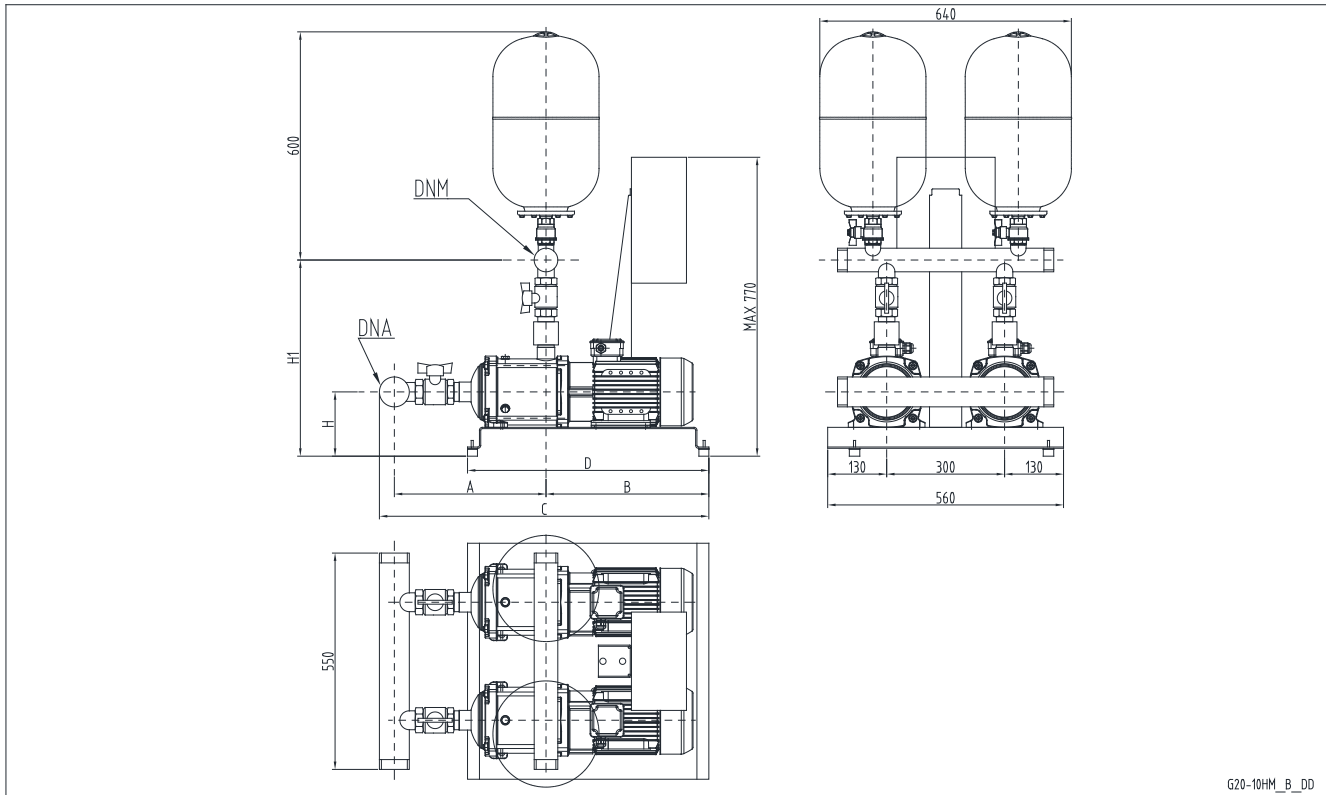
**BOOSTER SETS GMD SERIES
HM..P HORIZONTAL ELECTRIC PUMPS
DIMENSIONAL TABLE**

GMD 20	DNA	DNM	A	B	C	D	H	H1
10HM02	R 2"1/2	R 2"1/2	302	354	694	590	205	547
10HM03	R 2"1/2	R 2"1/2	302	354	694	590	205	547
10HM04	R 2"1/2	R 2"1/2	334	354	726	590	205	547
10HM05	R 2"1/2	R 2"1/2	366	390	794	590	205	547
10HM06	R 2"1/2	R 2"1/2	398	390	826	590	205	547

 Dimensions in mm. Tolerance ± 10 mm.

gmd20_10hm_c_td

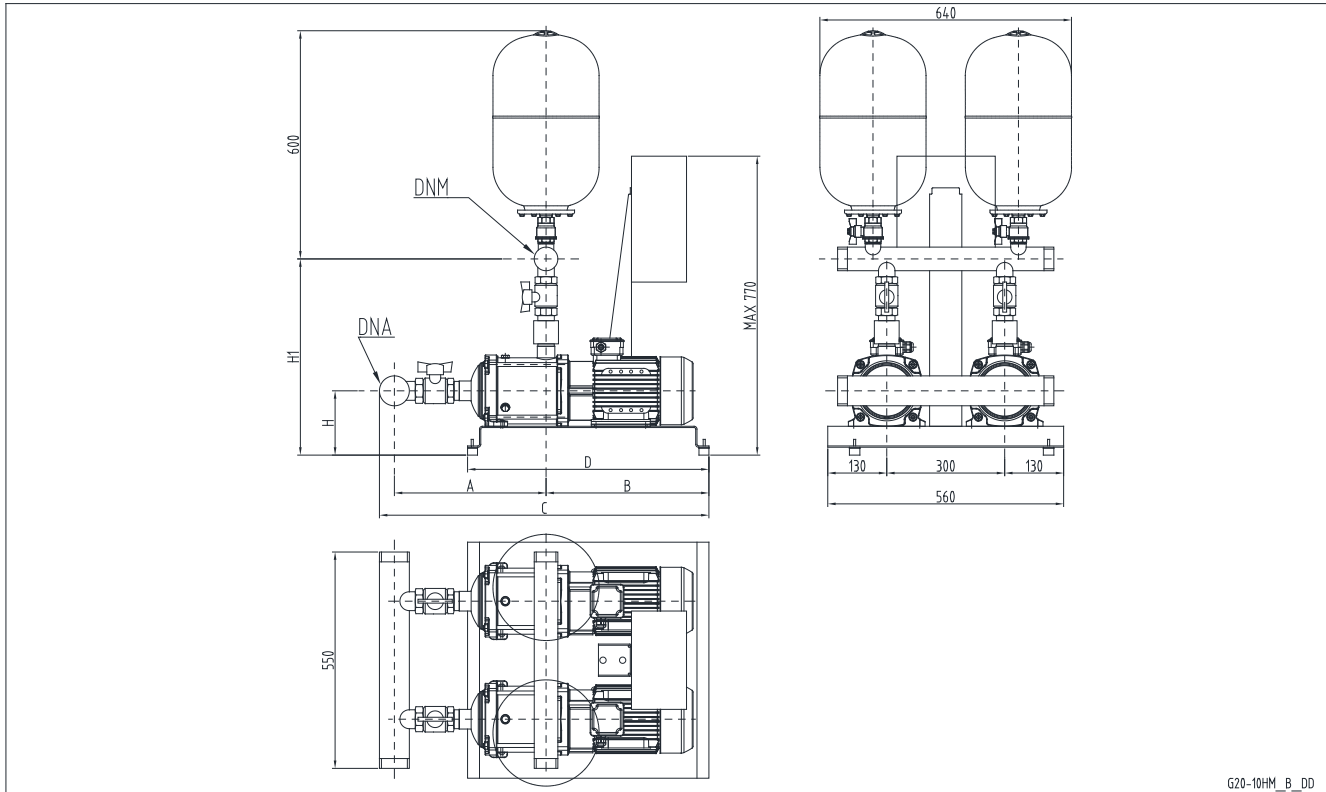
**BOOSTER SETS GMD SERIES
HM..S HORIZONTAL ELECTRIC PUMPS
DIMENSIONAL TABLE**

G20-10HM_B_DD

GMD 20	DNA	DNM	A	B	C	D	H	H1
3HM10	R 2"	R 2"	348	354	732	590	205	490
3HM11	R 2"	R 2"	368	354	752	590	205	490
3HM12	R 2"	R 2"	388	354	772	590	205	490
3HM13	R 2"	R 2"	408	354	792	762	205	490
3HM14	R 2"	R 2"	428	354	812	762	205	490
3HM16	R 2"	R 2"	468	354	852	762	205	490
3HM17	R 2"	R 2"	488	354	872	762	205	490
3HM19	R 2"	R 2"	528	377	935	762	205	490
3HM21	R 2"	R 2"	568	390	988	902	205	490
5HM09	R 2"	R 2"	389	354	773	590	205	490
5HM10	R 2"	R 2"	414	354	798	762	205	490
5HM11	R 2"	R 2"	439	354	823	762	205	490
5HM12	R 2"	R 2"	464	390	884	762	205	490
5HM13	R 2"	R 2"	489	390	909	762	205	490
5HM14	R 2"	R 2"	514	390	934	762	205	490
5HM15	R 2"	R 2"	539	390	959	762	205	490
5HM17	R 2"	R 2"	589	390	1009	902	205	490
5HM19	R 2"	R 2"	639	390	1059	902	205	490
5HM21	R 2"	R 2"	689	390	1109	902	205	490
10HM07	R 2"1/2	R 2"1/2	430	390	858	762	205	547
10HM08	R 2"1/2	R 2"1/2	462	390	890	762	205	547
10HM09	R 2"1/2	R 2"1/2	494	417	949	762	215	557
10HM10	R 2"1/2	R 2"1/2	526	417	981	762	215	557
10HM11	R 2"1/2	R 2"1/2	558	417	1013	902	215	557
15HM02	R3"	R3"	362	371	777	590	205	651
15HM03	R3"	R3"	362	407	813	590	205	651
15HM04	R3"	R3"	410	407	861	590	205	651
15HM05	R3"	R3"	458	433	935	762	215	661
22HM02	R3"	R3"	362	414	820	590	205	651
22HM03	R3"	R3"	362	414	820	590	205	651
22HM04	R3"	R3"	410	433	887	762	215	661

 Dimensions in mm. Tolerance ± 10 mm.

gmd20_3-22hms_d_td

**BOOSTER SETS GMD SERIES
BG / CEA HORIZONTAL ELECTRIC PUMPS
DIMENSIONAL TABLE**

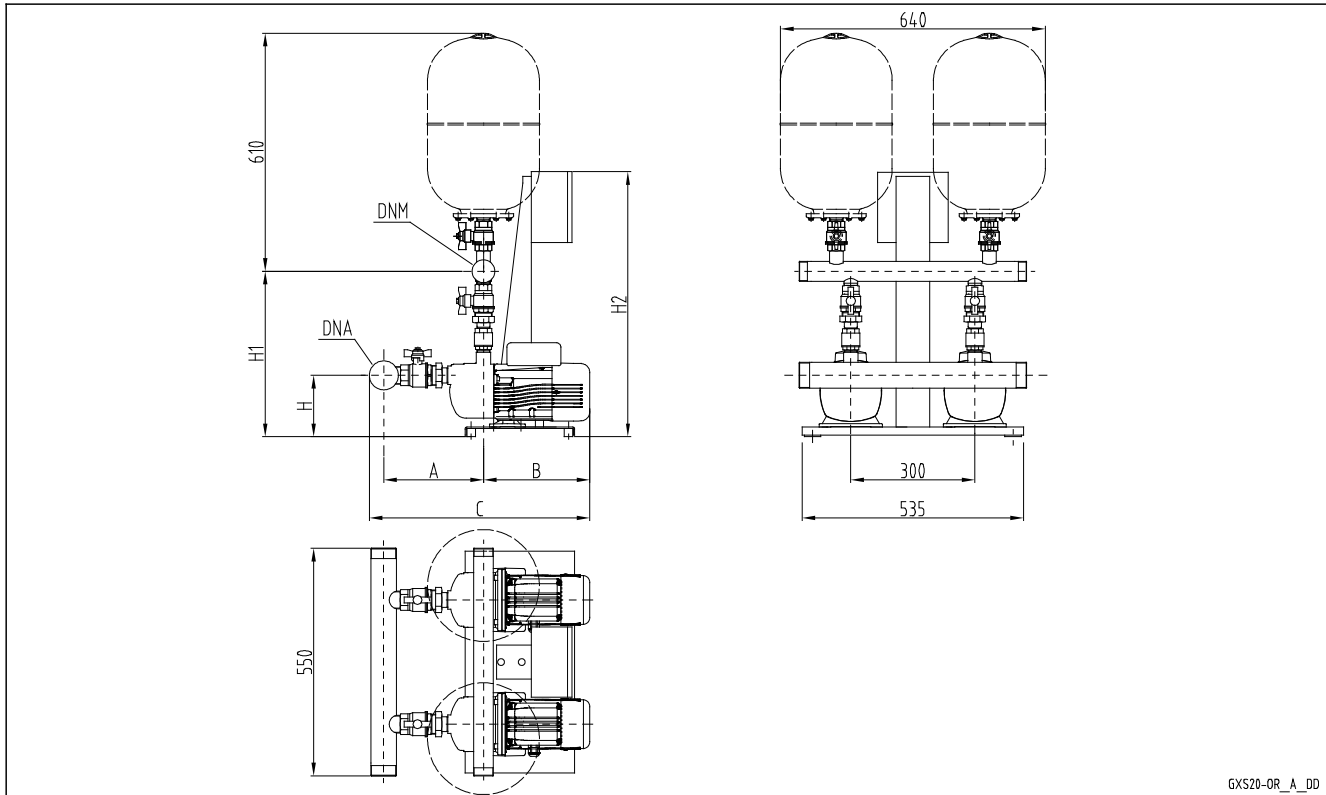

GXS20-OR_A_DD

GMD 20	DNA	DNM	A	B	C	H	H1	H2
BG3	R 2"	R 1 1/2"	225	297	552	189	431	640
BG5	R 2"	R 1 1/2"	225	311	566	189	431	640
BG7	R 2"	R 1 1/2"	225	356	611	189	431	640
BG9	R 2"	R 1 1/2"	225	356	611	189	431	640
BG11	R 2"	R 1 1/2"	225	356	611	189	431	640
CEA70/3	R 2"	R 1 1/2"	207	260	497	134	429	640
CEA70/5	R 2"	R 1 1/2"	207	274	511	134	429	640
CEA80/5	R 2"	R 1 1/2"	207	320	557	134	429	640
CEA120/3	R 2"	R 2"	207	274	511	134	453	640
CEA120/5	R 2"	R 2"	220	320	570	134	453	640
CEA210/2	R 2" 1/2	R 2 1/2"	231	331	600	134	493	640
CEA210/3	R 2" 1/2	R 2 1/2"	231	331	600	134	493	640
CEA210/4	R 2" 1/2	R 2 1/2"	231	375	644	134	493	640
CEA210/5	R 2" 1/2	R 2 1/2"	231	375	644	134	493	640
CEA370/1	R 3"	R 2 1/2"	272	331	647	134	578	640
CEA370/2	R 3"	R 2 1/2"	272	375	691	134	578	640
CEA370/3	R 3"	R 2 1/2"	272	375	691	134	578	640
CEA370/5	R 3"	R 2 1/2"	272	375	691	134	578	640

Dimensions in mm. Tolerance ± 10 mm.

qmd20 or i td

BOOSTER SETS GMD SERIES
e-SV VERTICAL ELECTRIC PUMPS
DIMENSIONAL TABLE

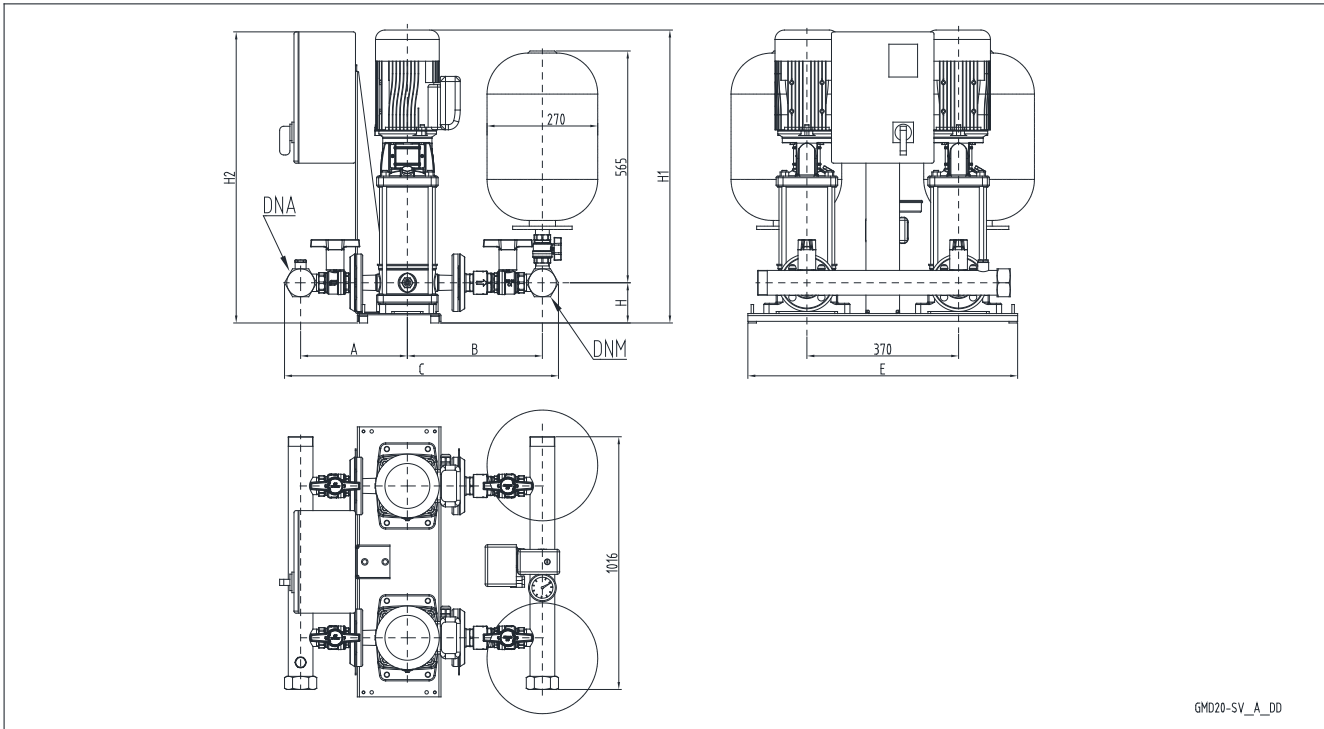

GMD20-SV_A_DD

GMD 20	DNA	DNM	A	B	C	E	H	H1	H2
3SV02F003T	R 2"	R 2"	256	311	627	658	98	510	700
3SV03F003T	R 2"	R 2"	256	311	627	658	98	510	700
3SV04F003T	R 2"	R 2"	256	311	627	658	98	530	700
3SV05F005T	R 2"	R 2"	256	311	627	658	98	572	700
3SV06F005T	R 2"	R 2"	256	311	627	658	98	592	700
3SV07F007T	R 2"	R 2"	256	311	627	658	98	654	700
3SV08F007T	R 2"	R 2"	256	311	627	658	98	674	700
3SV09F011T	R 2"	R 2"	256	311	627	658	98	694	700
3SV10F011T	R 2"	R 2"	256	311	627	658	98	714	700
3SV11F011T	R 2"	R 2"	256	311	627	658	98	734	700
3SV12F011T	R 2"	R 2"	256	311	627	658	98	754	700
3SV13F015T	R 2"	R 2"	256	311	627	658	98	784	700
3SV14F015T	R 2"	R 2"	256	311	627	658	98	804	700
3SV16F015T	R 2"	R 2"	256	311	627	658	98	844	700
3SV19F022T	R 2"	R 2"	256	311	627	658	98	939	700
3SV21F022T	R 2"	R 2"	256	311	627	658	98	979	700
5SV02F003T	R 2"	R 2"	260	329	649	658	98	500	700
5SV03F005T	R 2"	R 2"	260	329	649	658	98	547	700
5SV04F005T	R 2"	R 2"	260	329	649	658	98	572	700
5SV05F007T	R 2"	R 2"	260	329	649	658	98	639	700
5SV06F011T	R 2"	R 2"	260	329	649	658	98	664	700
5SV07F011T	R 2"	R 2"	260	329	649	658	98	689	700
5SV08F011T	R 2"	R 2"	260	329	649	658	98	714	700
5SV09F015T	R 2"	R 2"	260	329	649	658	98	749	700
5SV10F015T	R 2"	R 2"	260	329	649	658	98	774	700
5SV11F015T	R 2"	R 2"	260	329	649	658	98	799	700
5SV12F022T	R 2"	R 2"	260	329	649	658	98	859	700
5SV13F022T	R 2"	R 2"	260	329	649	658	98	884	700
5SV14F022T	R 2"	R 2"	260	329	649	658	98	909	700
5SV15F022T	R 2"	R 2"	260	329	649	658	98	934	700
5SV16F022T	R 2"	R 2"	260	329	649	658	98	959	700
5SV18F030T	R 2"	R 2"	260	329	649	682	109	1030	720
5SV21F030T	R 2"	R 2"	260	329	649	682	109	1105	720

Dimensions in mm. Tolerance ± 10 mm.

gmd20_esv-f-1_a_td

BOOSTER SETS GMD SERIES
e-SV VERTICAL ELECTRIC PUMPS
DIMENSIONAL TABLE

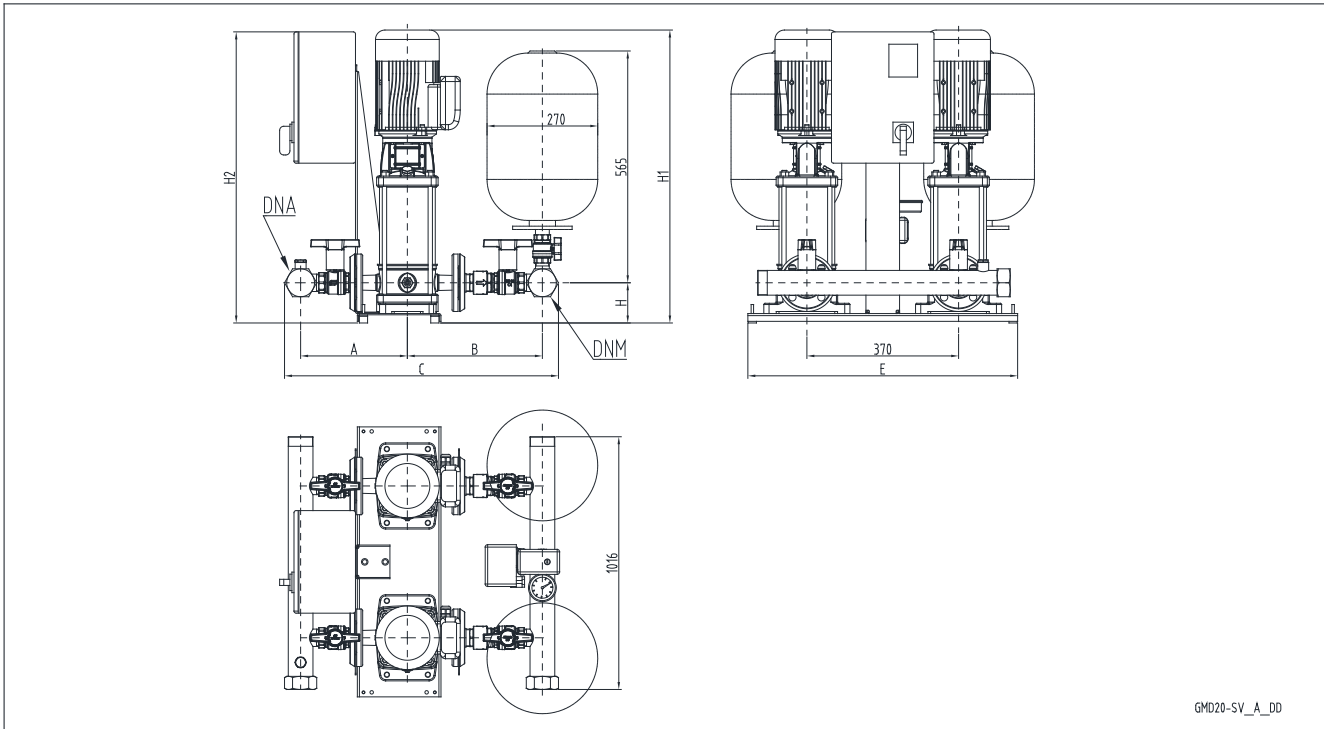

GMD20-SV_A_DD

GMD 20	DNA	DNM	A	B	C	E	H	H1	H2
10SV01F007T	R 2 ¹ / ₂	R 2 ¹ / ₂	294	356	726	682	114	654	720
10SV02F007T	R 2 ¹ / ₂	R 2 ¹ / ₂	294	356	726	682	114	654	720
10SV03F011T	R 2 ¹ / ₂	R 2 ¹ / ₂	294	356	726	682	114	686	720
10SV04F015T	R 2 ¹ / ₂	R 2 ¹ / ₂	294	356	726	682	114	728	720
10SV05F022T	R 2 ¹ / ₂	R 2 ¹ / ₂	294	356	726	682	114	795	720
10SV06F022T	R 2 ¹ / ₂	R 2 ¹ / ₂	294	356	726	682	114	827	720
10SV07F030T	R 2 ¹ / ₂	R 2 ¹ / ₂	294	356	726	682	114	869	720
10SV08F030T	R 2 ¹ / ₂	R 2 ¹ / ₂	294	356	726	682	114	901	720
10SV09F040T	R 2 ¹ / ₂	R 2 ¹ / ₂	294	356	726	682	114	954	720
10SV10F040T	R 2 ¹ / ₂	R 2 ¹ / ₂	294	356	726	682	114	986	720
10SV11F040T	R 2 ¹ / ₂	R 2 ¹ / ₂	294	356	726	682	114	1018	720

Dimensions in mm. Tolerance ± 10 mm.

gmd20_esv-f-2_a_td

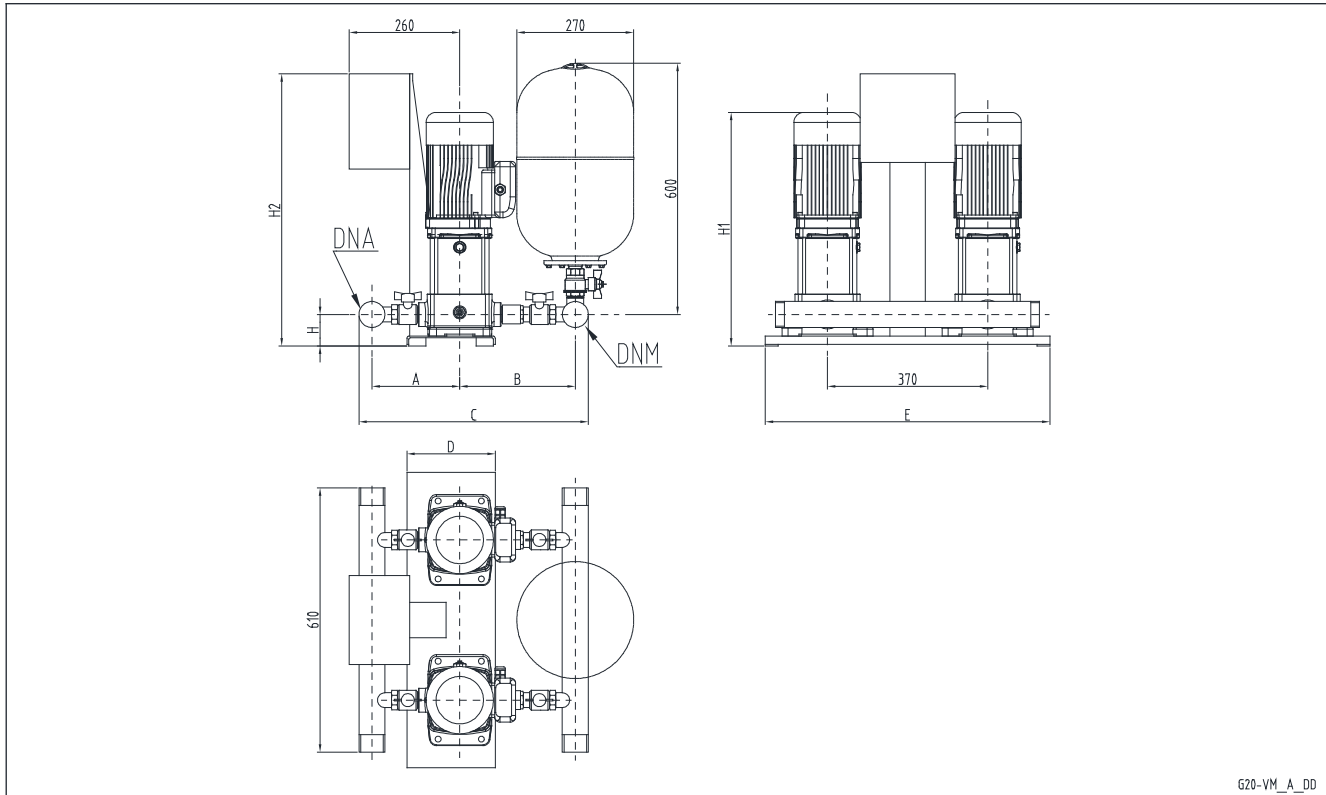
**BOOSTER SETS GMD SERIES
VM VERTICAL ELECTRIC PUMPS
DIMENSIONAL TABLE**

G20-VM_A_DD

GMD 20	DNA	DNM	A	B	C	D	E	H	H1	H2
3VM02	R2"	R2"	232	287	579	204	658	73	402	709
3VM03	R2"	R2"	232	287	579	204	658	73	402	709
3VM04	R2"	R2"	232	287	579	204	658	73	422	709
3VM05	R2"	R2"	232	287	579	204	658	73	500	709
3VM06	R2"	R2"	232	287	579	204	658	73	520	709
3VM07	R2"	R2"	232	287	579	204	658	73	540	709
3VM08	R2"	R2"	232	287	579	204	658	73	560	709
5VM02	R2"	R2"	251	320	631	204	658	73	402	709
5VM03	R2"	R2"	251	320	631	204	658	73	402	709
5VM04	R2"	R2"	251	320	631	204	658	73	480	709
5VM05	R2"	R2"	251	320	631	204	658	73	500	709
5VM06	R2"	R2"	251	320	631	204	658	73	520	709
5VM07	R2"	R2"	251	320	631	204	658	73	540	709
5VM08	R2"	R2"	251	320	631	204	658	73	616	709
10VM02	R2"1/2	R2"1/2	287	354	717	235	682	114	535	720
10VM03	R2"1/2	R2"1/2	287	354	717	235	682	114	567	720
10VM04	R2"1/2	R2"1/2	287	354	717	235	682	114	655	720
10VM05	R2"1/2	R2"1/2	287	354	717	235	682	114	687	720
10VM06	R2"1/2	R2"1/2	287	354	717	235	682	114	719	720

 Dimensions in mm. Tolerance ± 10 mm.

gmd20_vm_e_td

PERFORMANCE CURVES

BOOSTER SETS GX5 AND GMD SERIES OPERATING CHARACTERISTICS AT 50 Hz

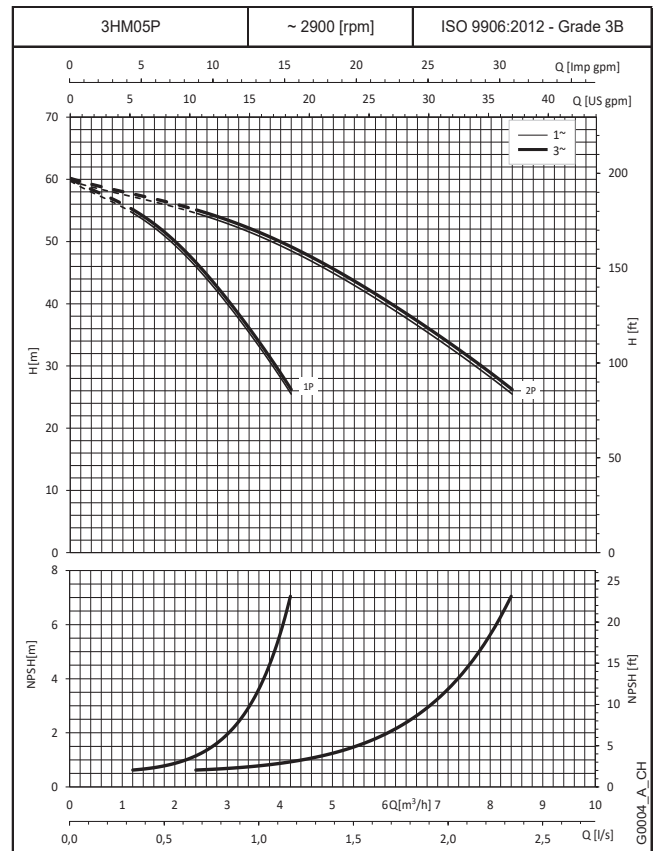
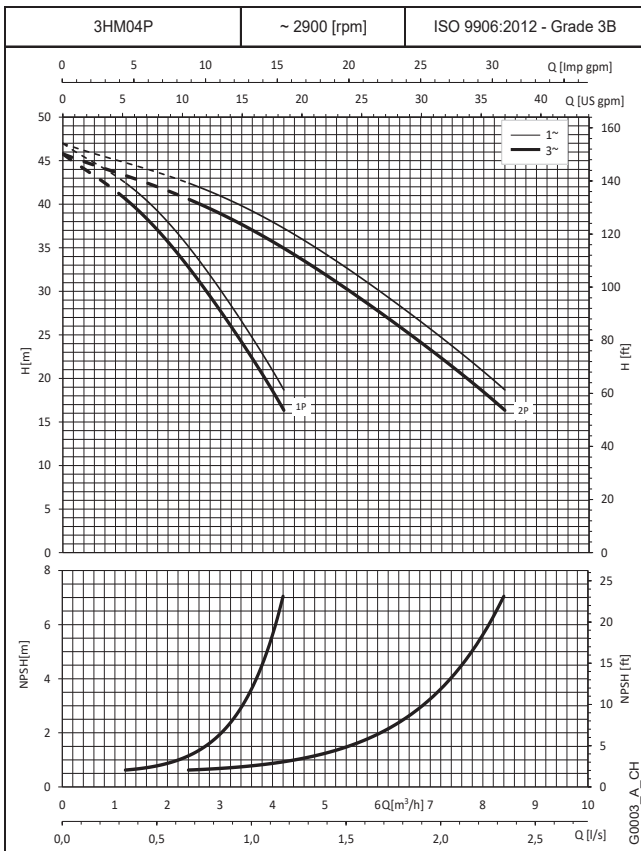
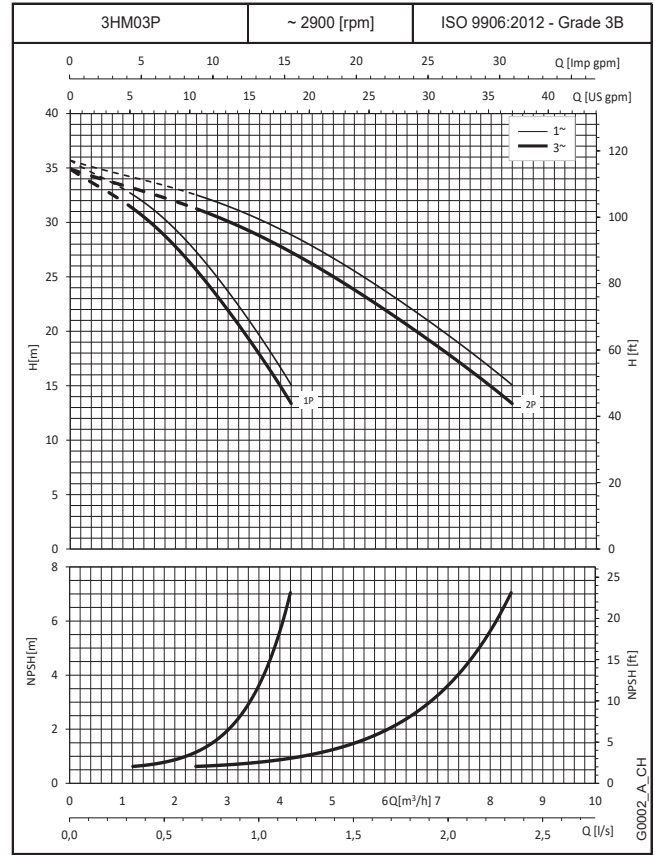
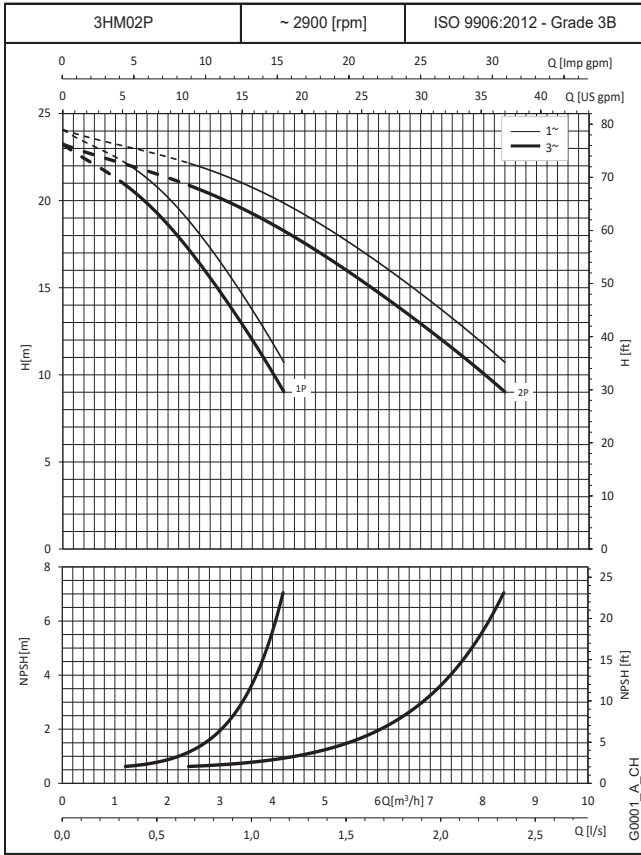

The performance curves do not take into account flow resistance in the valves and piping.
 The curves show the performance with one and two pumps running.
 These performances are valid for liquids with density $\rho = 1.0 \text{ kg/dm}^3$ and kinematic viscosity $\nu = 1 \text{ mm}^2/\text{sec}$.
 The declared NPSH values are laboratory values: for practical use we recommend increasing these values by 0,5 m.

BOOSTER SETS GX5 AND GMD SERIES OPERATING CHARACTERISTICS AT 50 Hz

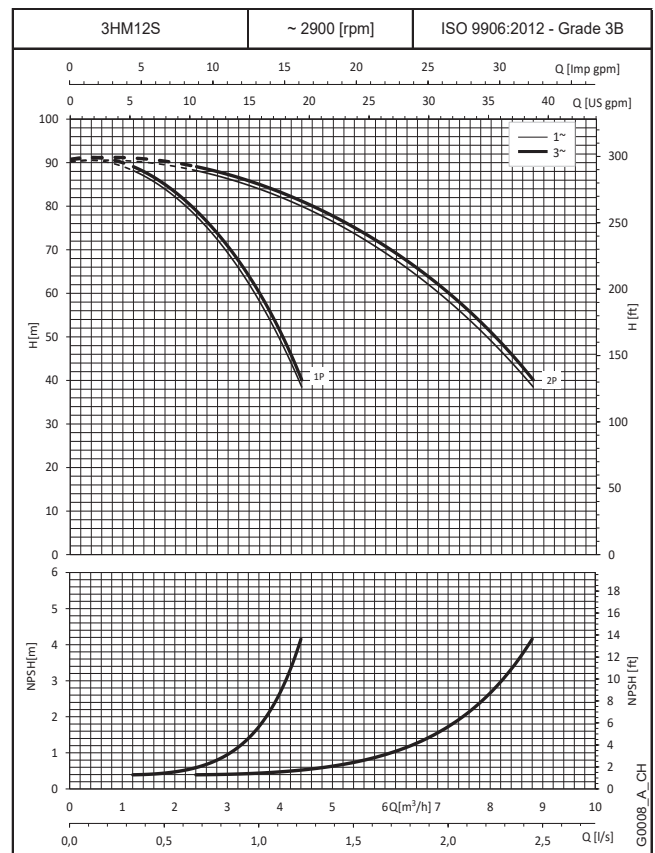
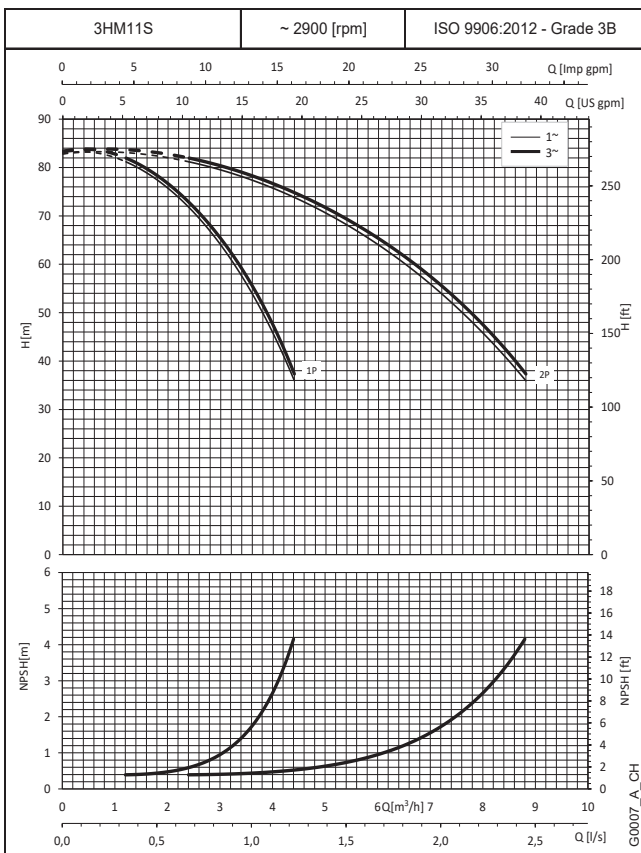
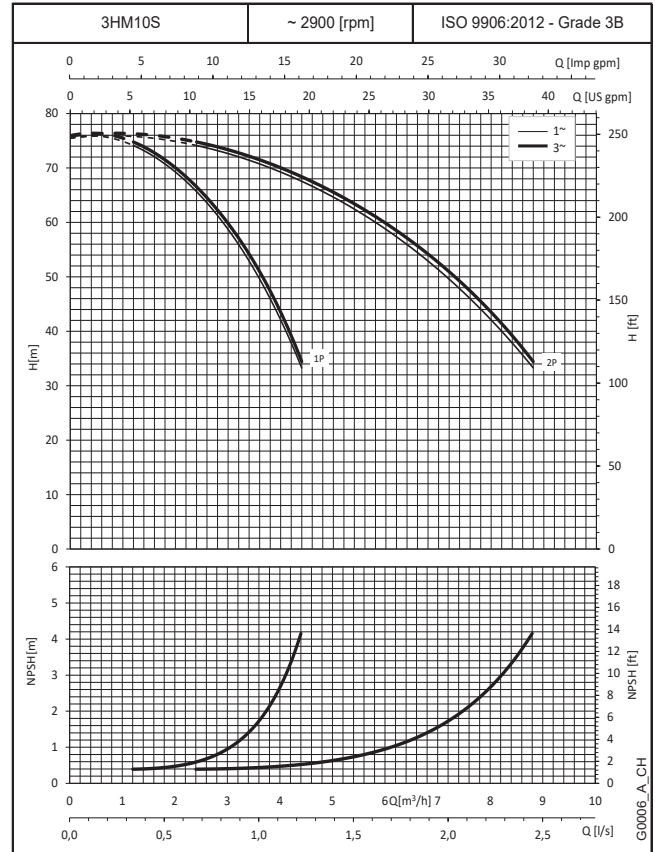
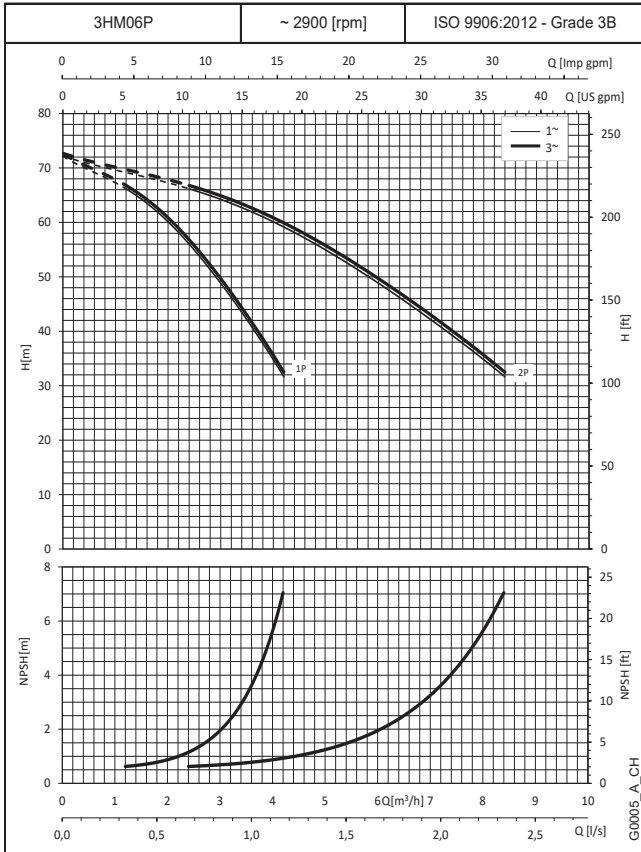

The performance curves do not take into account flow resistance in the valves and piping.
 The curves show the performance with one and two pumps running.
 These performances are valid for liquids with density $\rho = 1.0 \text{ kg/dm}^3$ and kinematic viscosity $\nu = 1 \text{ mm}^2/\text{sec}$.
 The declared NPSH values are laboratory values: for practical use we recommend increasing these values by 0,5 m.

**BOOSTER SETS GX5 AND GMD SERIES
OPERATING CHARACTERISTICS AT 50 Hz**

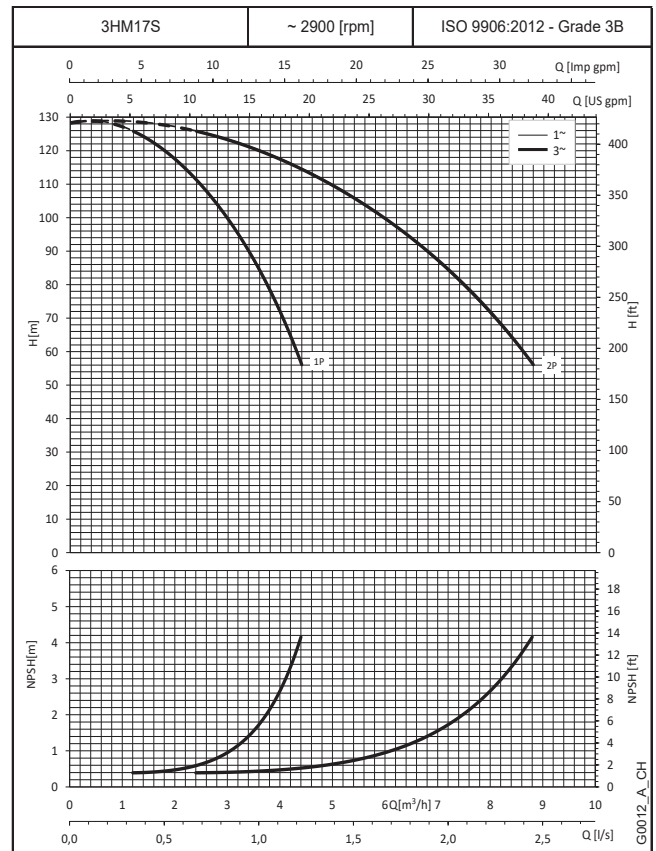
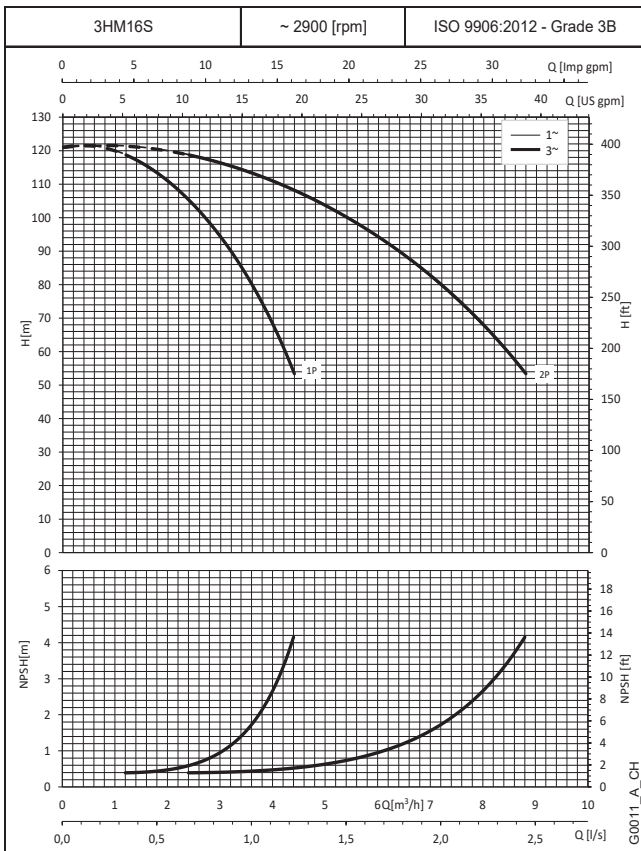
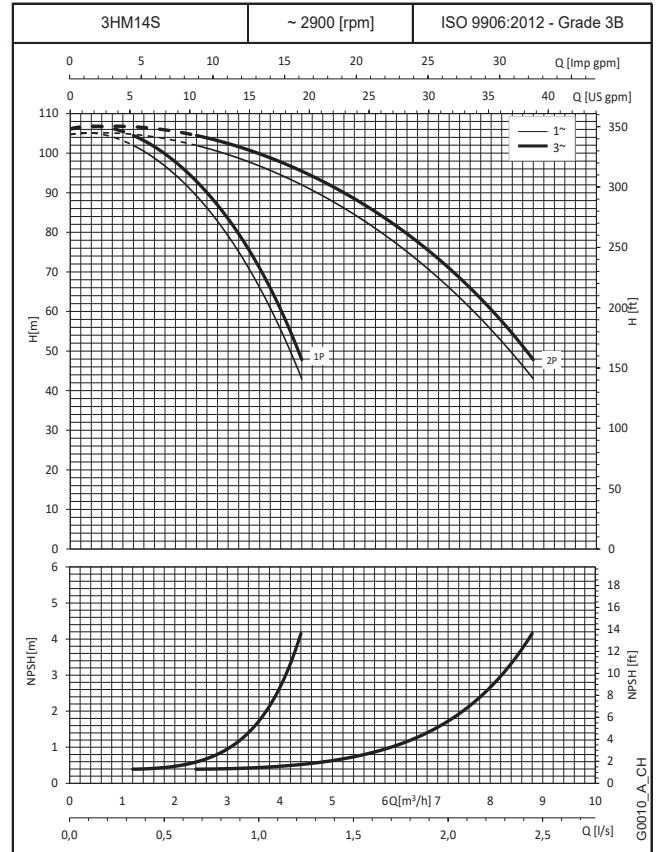
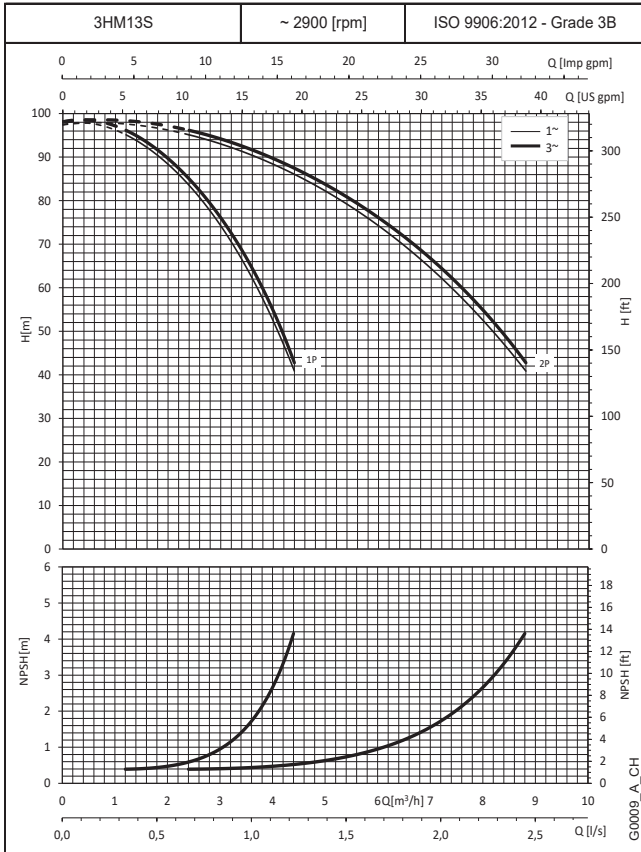

The performance curves do not take into account flow resistance in the valves and piping.
The curves show the performance with one and two pumps running.
These performances are valid for liquids with density $\rho = 1.0 \text{ kg/dm}^3$ and kinematic viscosity $\nu = 1 \text{ mm}^2/\text{sec}$.
The declared NPSH values are laboratory values: for practical use we recommend increasing these values by 0,5 m.

BOOSTER SETS GX5 AND GMD SERIES OPERATING CHARACTERISTICS AT 50 Hz

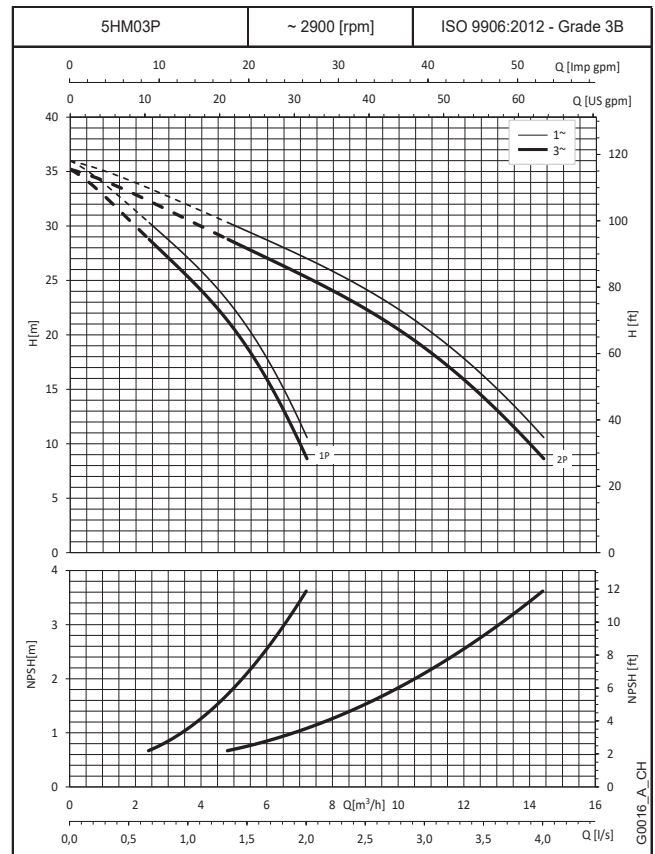
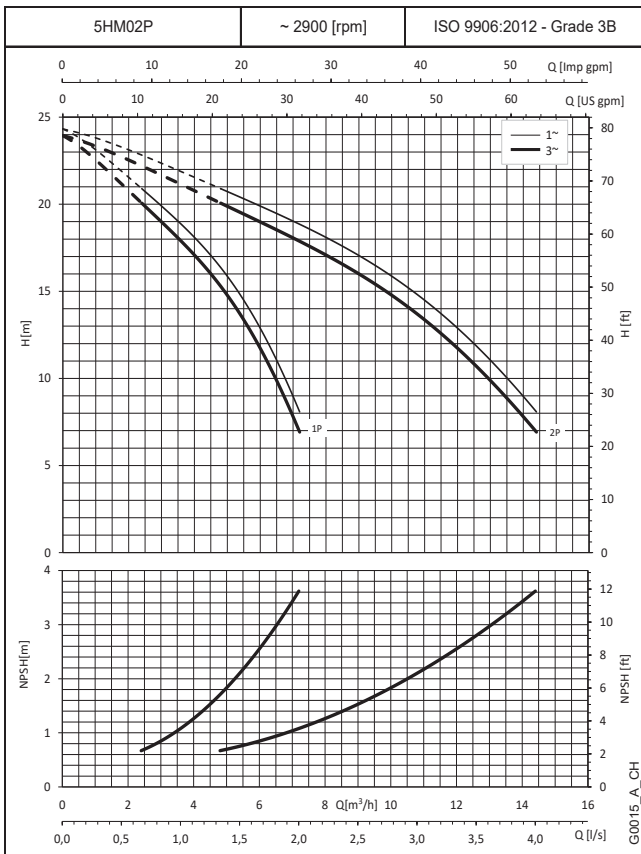
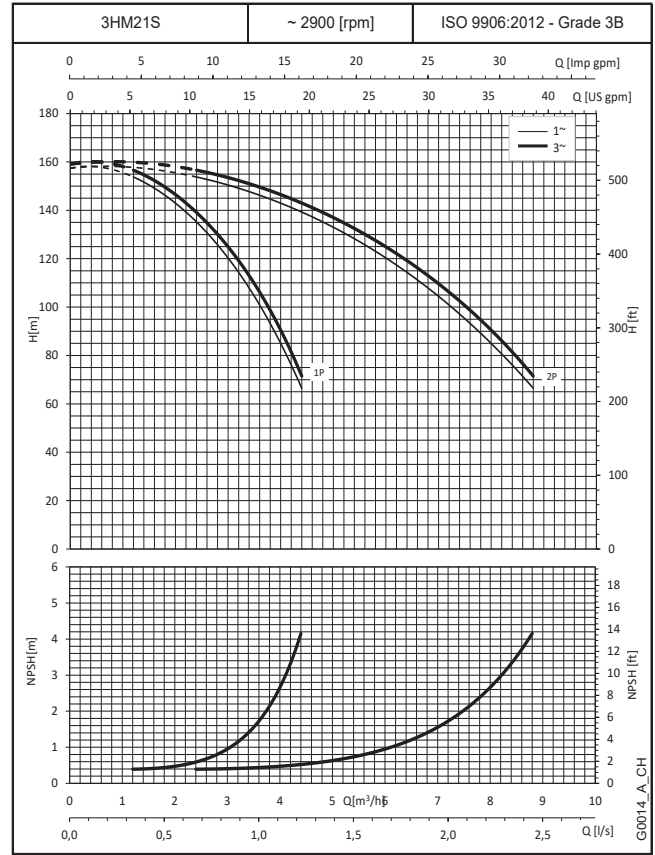
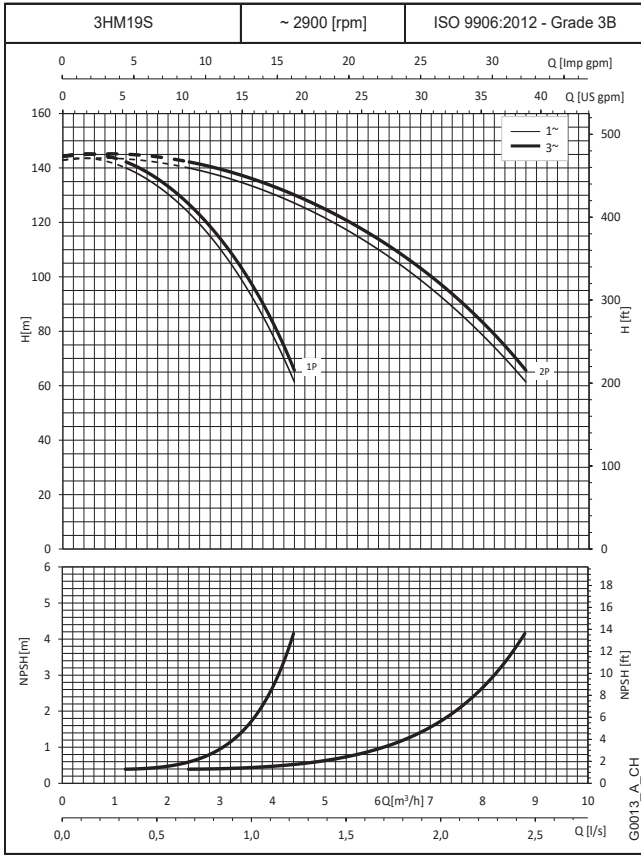

The performance curves do not take into account flow resistance in the valves and piping.
 The curves show the performance with one and two pumps running.
 These performances are valid for liquids with density $\rho = 1.0 \text{ kg/dm}^3$ and kinematic viscosity $\nu = 1 \text{ mm}^2/\text{sec}$.
 The declared NPSH values are laboratory values: for practical use we recommend increasing these values by 0,5 m.

BOOSTER SETS GX5 AND GMD SERIES OPERATING CHARACTERISTICS AT 50 Hz

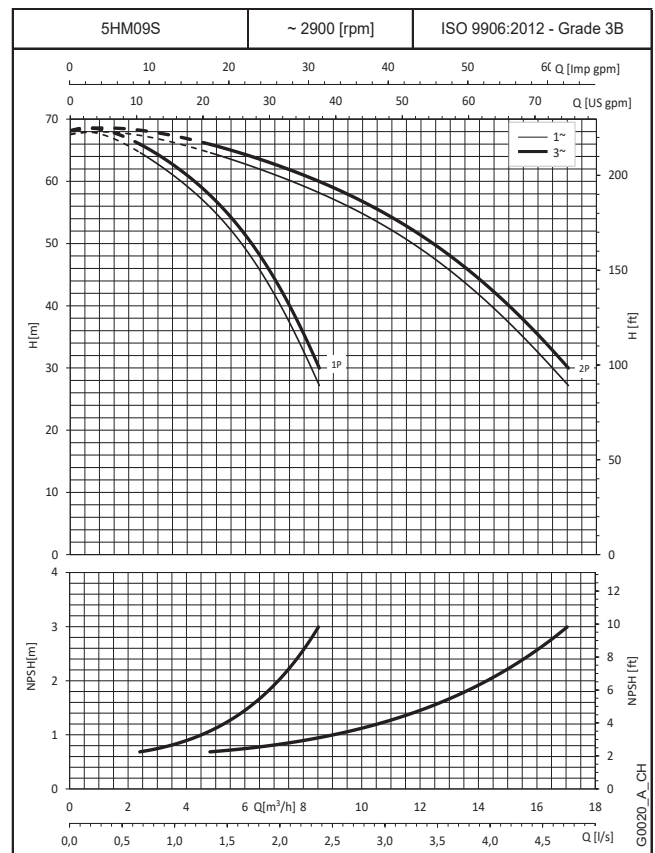
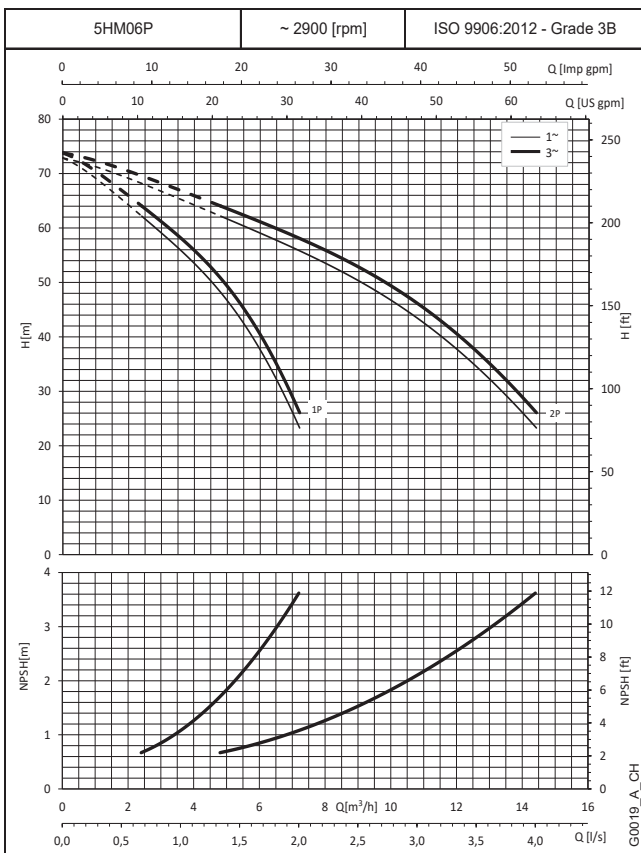
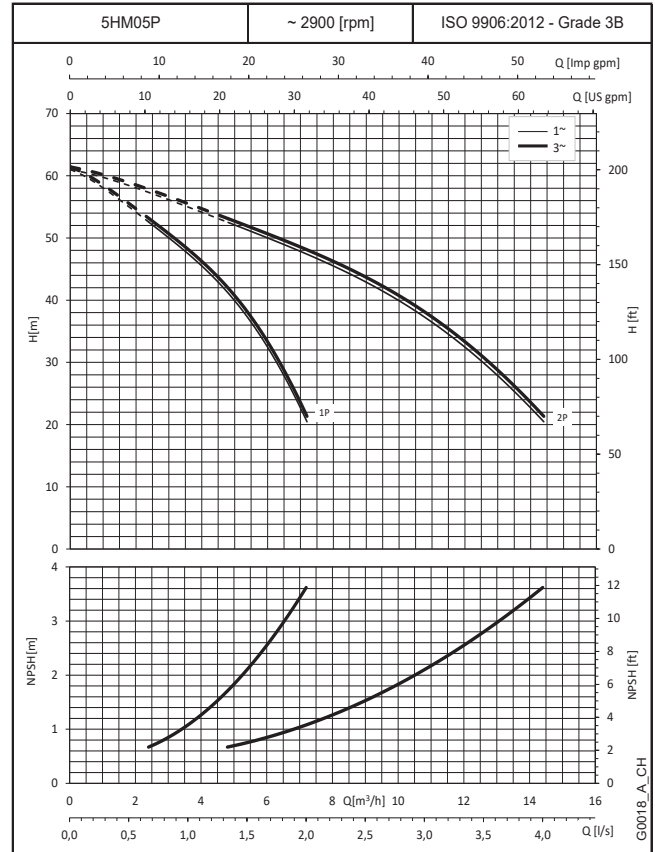
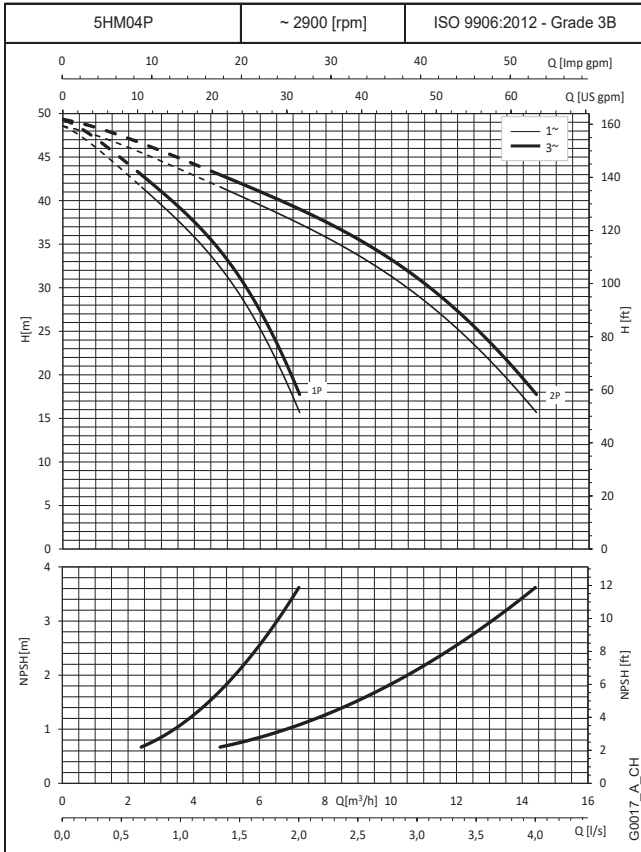

The performance curves do not take into account flow resistance in the valves and piping.
The curves show the performance with one and two pumps running.

These performances are valid for liquids with density $\rho = 1.0 \text{ kg/dm}^3$ and kinematic viscosity $\nu = 1 \text{ mm}^2/\text{sec}$.

The declared NPSH values are laboratory values: for practical use we recommend increasing these values by 0,5 m.

BOOSTER SETS GX5 AND GMD SERIES OPERATING CHARACTERISTICS AT 50 Hz

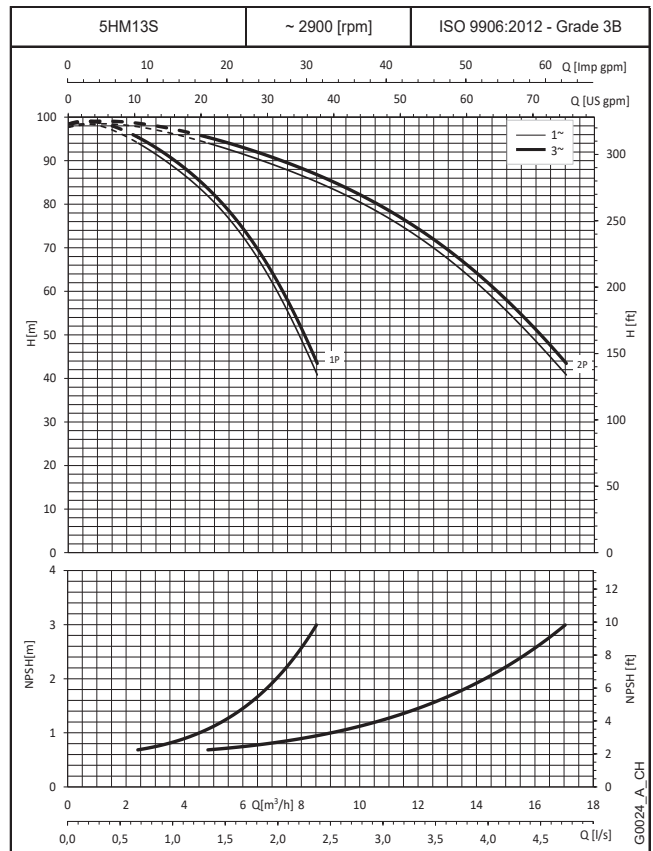
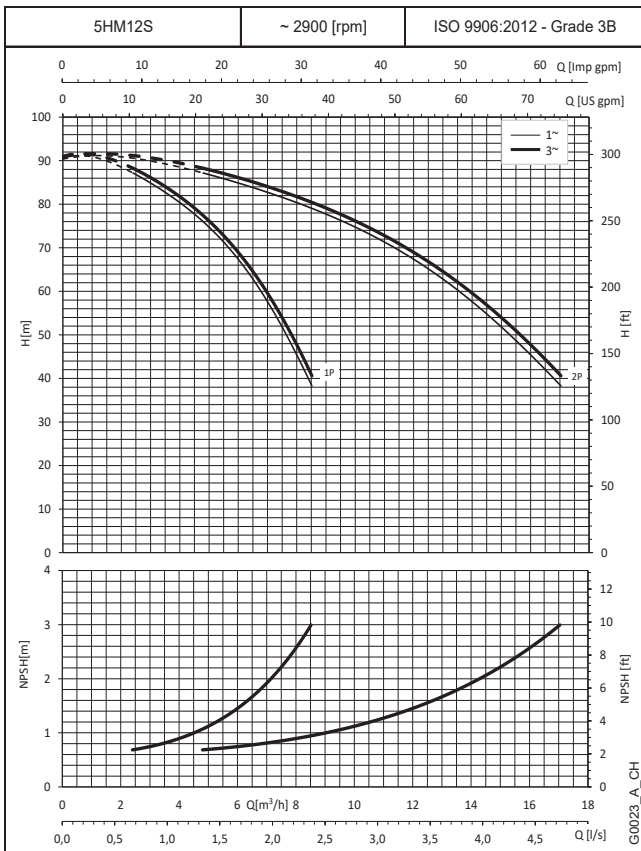
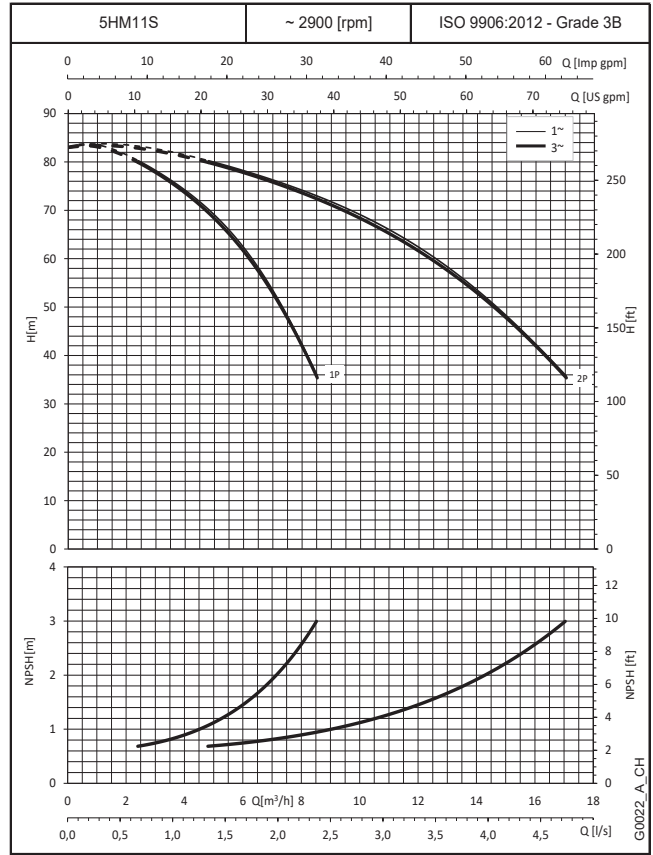
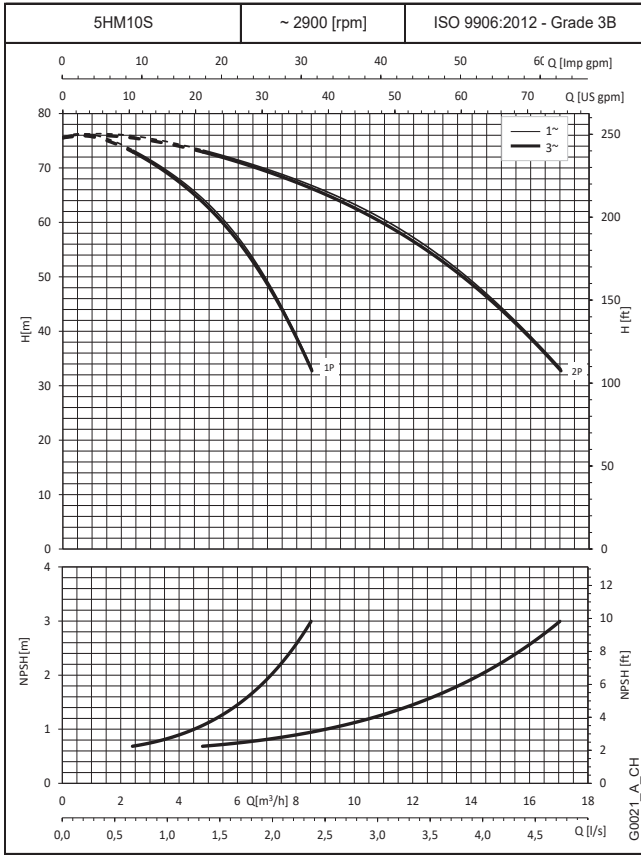

The performance curves do not take into account flow resistance in the valves and piping.
The curves show the performance with one and two pumps running.

These performances are valid for liquids with density $\rho = 1.0 \text{ kg/dm}^3$ and kinematic viscosity $\nu = 1 \text{ mm}^2/\text{sec}$.

The declared NPSH values are laboratory values: for practical use we recommend increasing these values by 0,5 m.

BOOSTER SETS GX5 AND GMD SERIES OPERATING CHARACTERISTICS AT 50 Hz

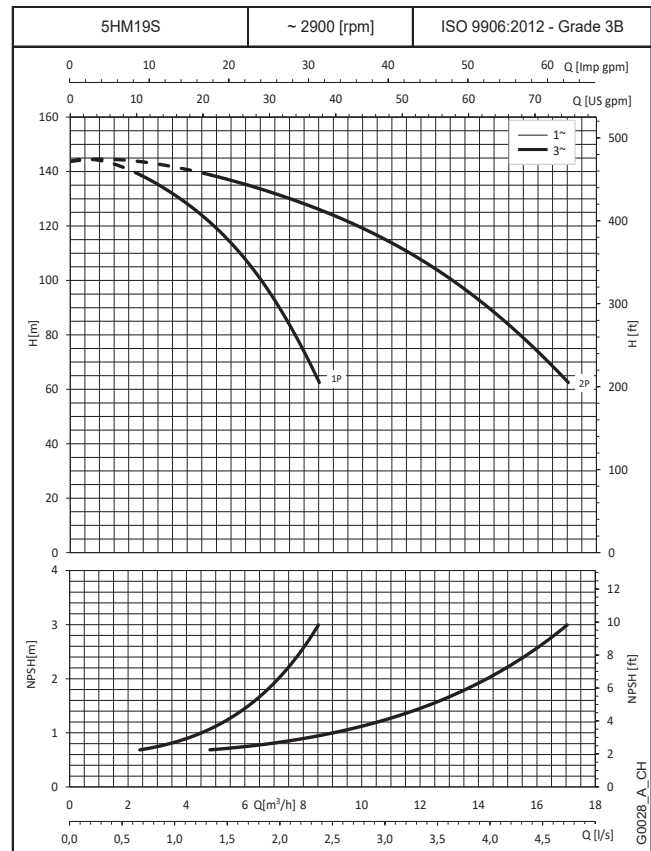
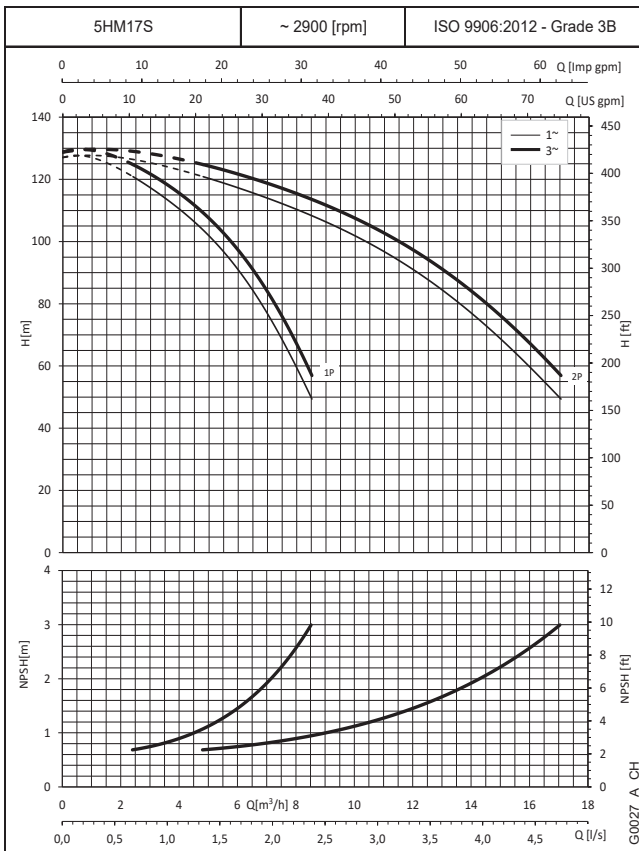
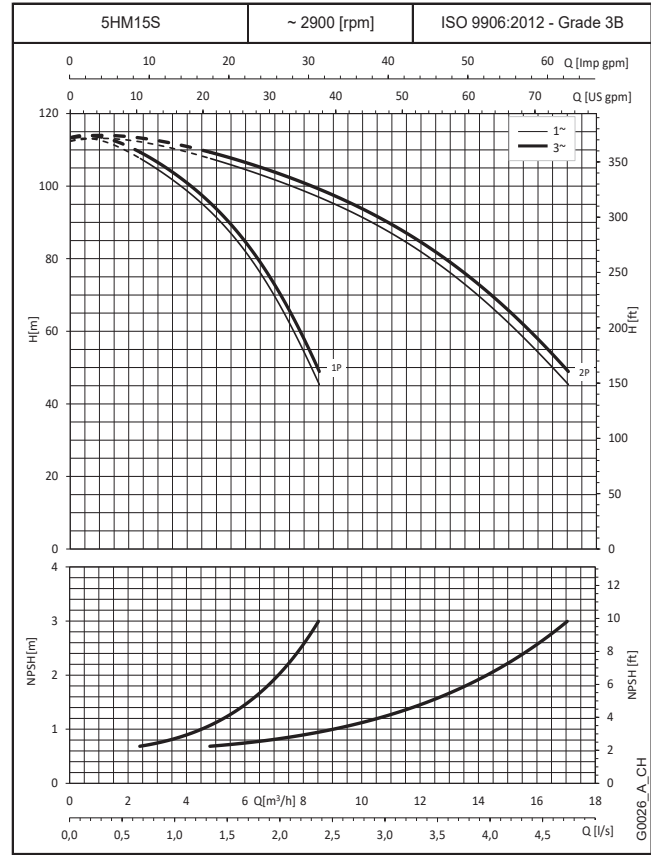
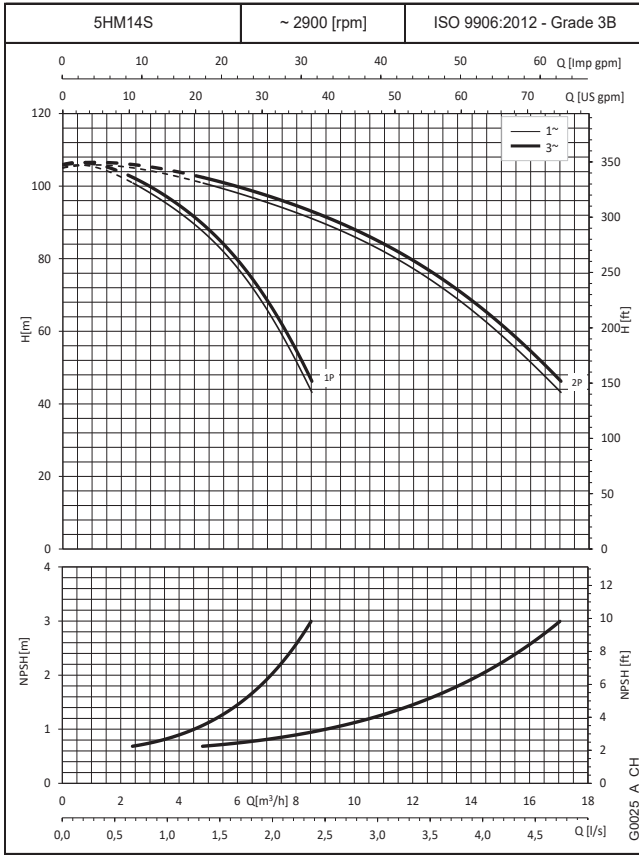

The performance curves do not take into account flow resistance in the valves and piping.
 The curves show the performance with one and two pumps running.
 These performances are valid for liquids with density $\rho = 1.0 \text{ kg/dm}^3$ and kinematic viscosity $\nu = 1 \text{ mm}^2/\text{sec}$.
 The declared NPSH values are laboratory values: for practical use we recommend increasing these values by 0,5 m.

BOOSTER SETS GX5 AND GMD SERIES OPERATING CHARACTERISTICS AT 50 Hz

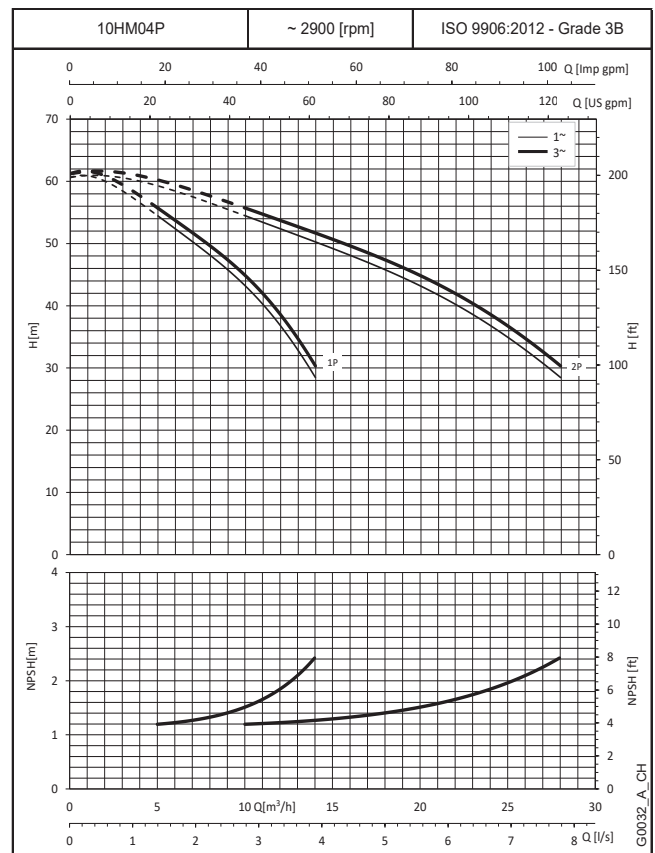
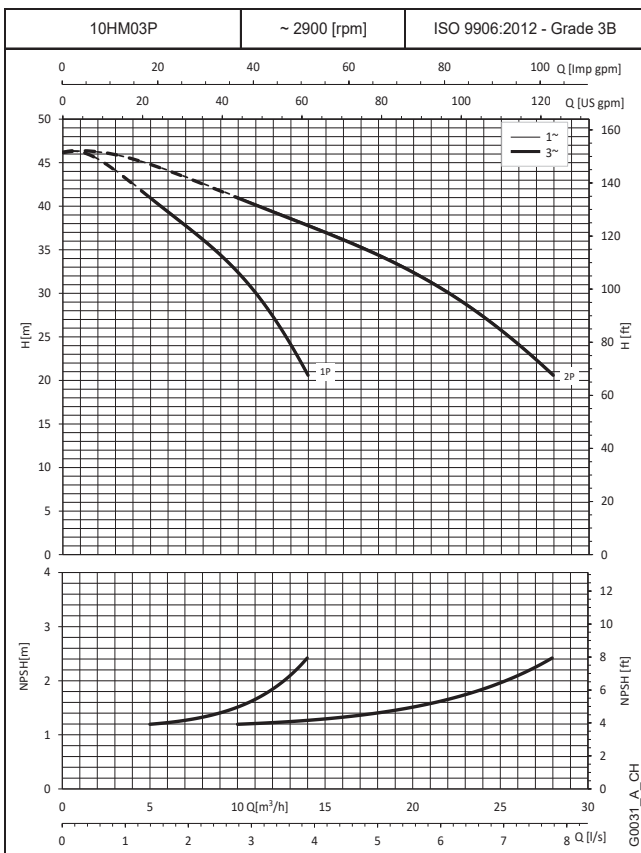
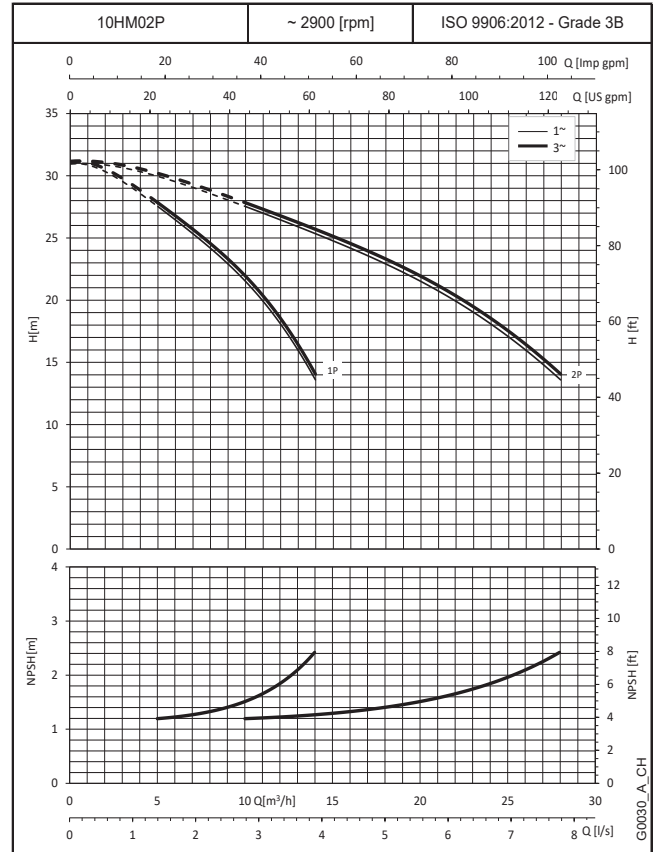
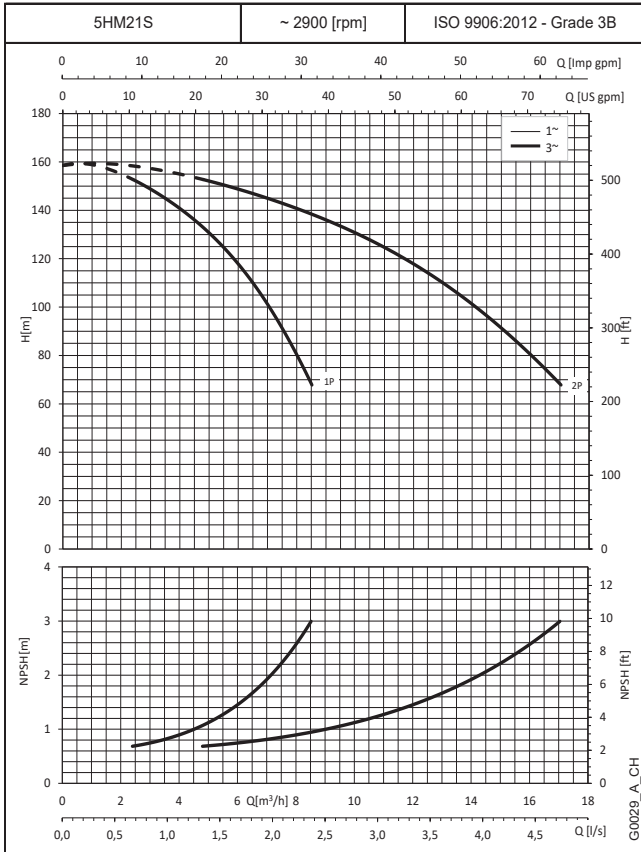

The performance curves do not take into account flow resistance in the valves and piping.
 The curves show the performance with one and two pumps running.
 These performances are valid for liquids with density $\rho = 1.0 \text{ kg/dm}^3$ and kinematic viscosity $\nu = 1 \text{ mm}^2/\text{sec}$.
 The declared NPSH values are laboratory values: for practical use we recommend increasing these values by 0,5 m.

BOOSTER SETS GX5 AND GMD SERIES OPERATING CHARACTERISTICS AT 50 Hz

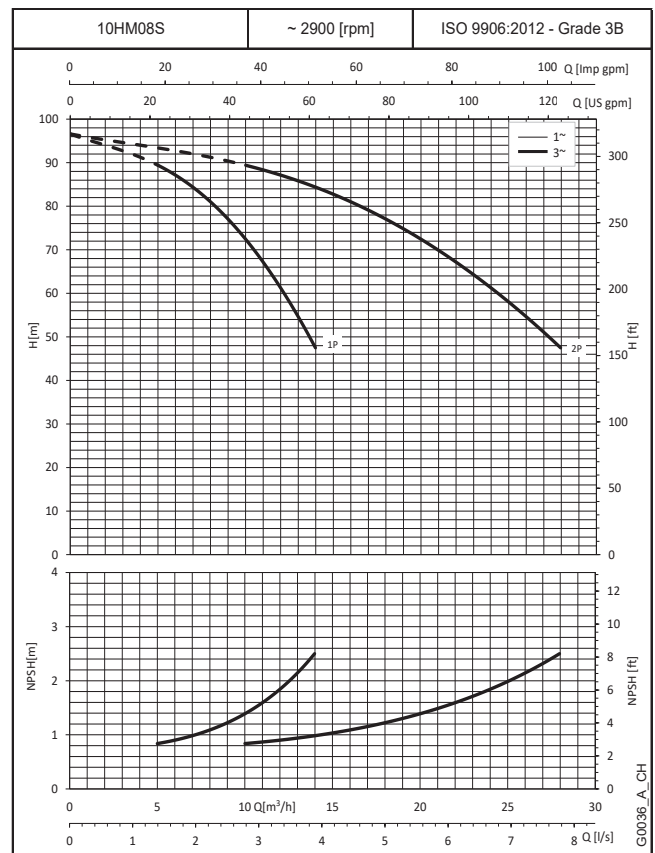
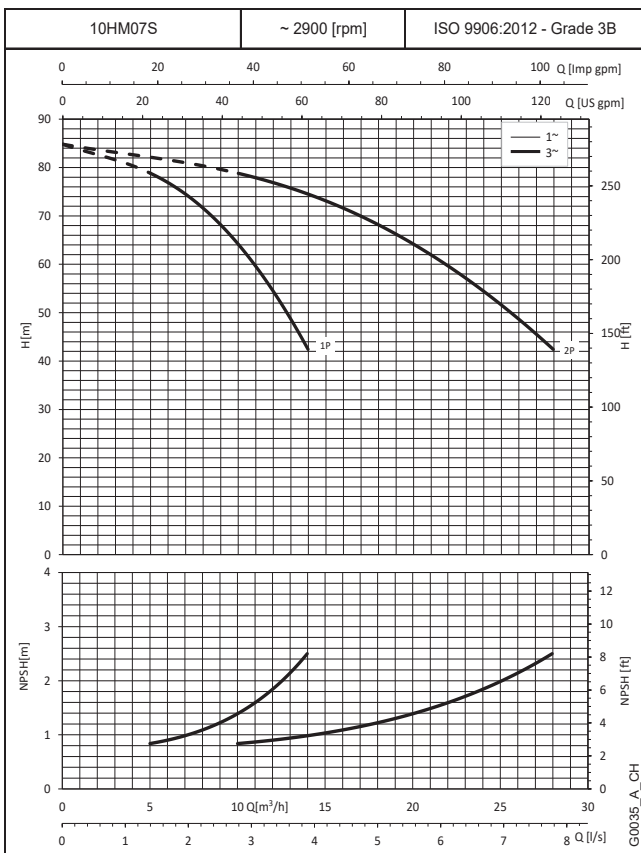
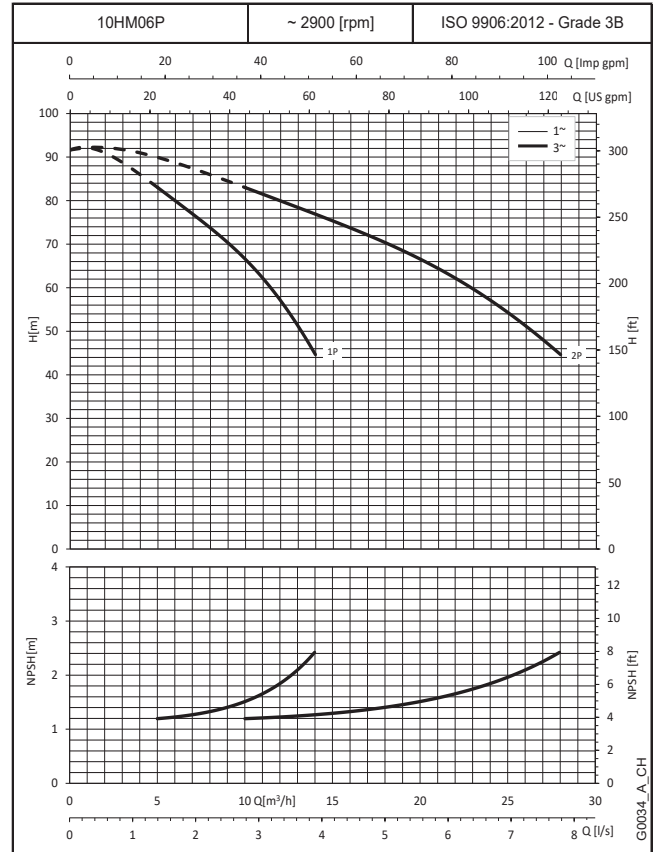
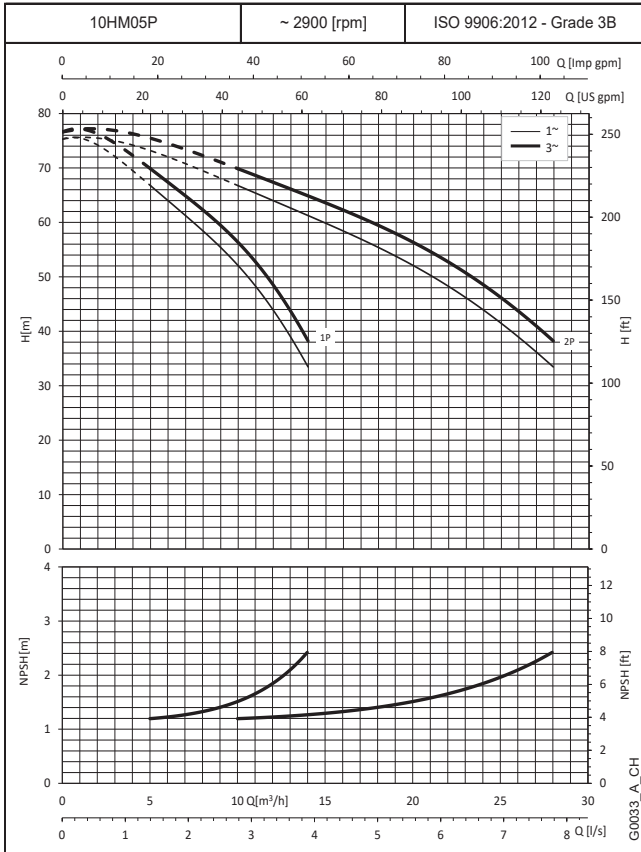

The performance curves do not take into account flow resistance in the valves and piping.
 The curves show the performance with one and two pumps running.
 These performances are valid for liquids with density $\rho = 1.0 \text{ kg/dm}^3$ and kinematic viscosity $\nu = 1 \text{ mm}^2/\text{sec}$.
 The declared NPSH values are laboratory values: for practical use we recommend increasing these values by 0,5 m.

**BOOSTER SETS GX5 AND GMD SERIES
OPERATING CHARACTERISTICS AT 50 Hz**

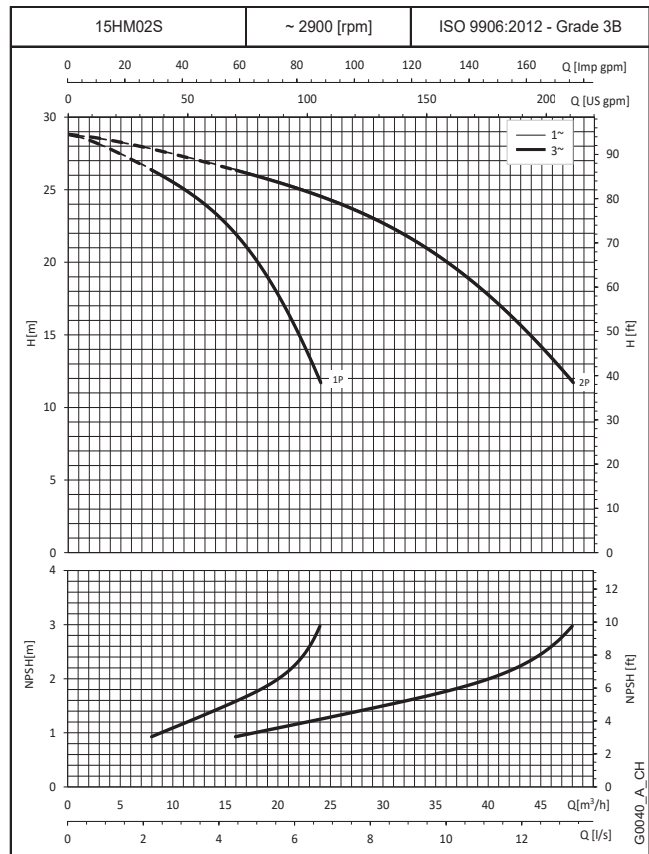
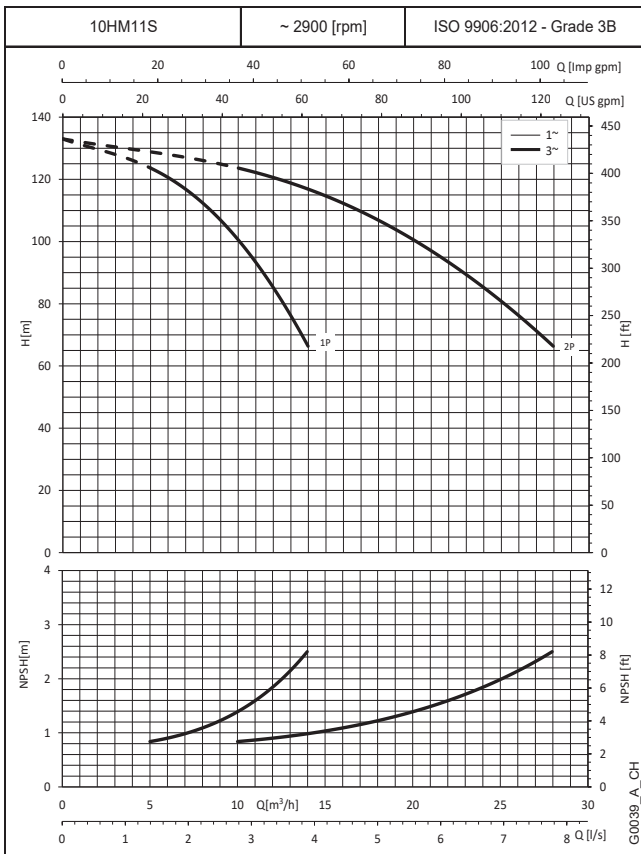
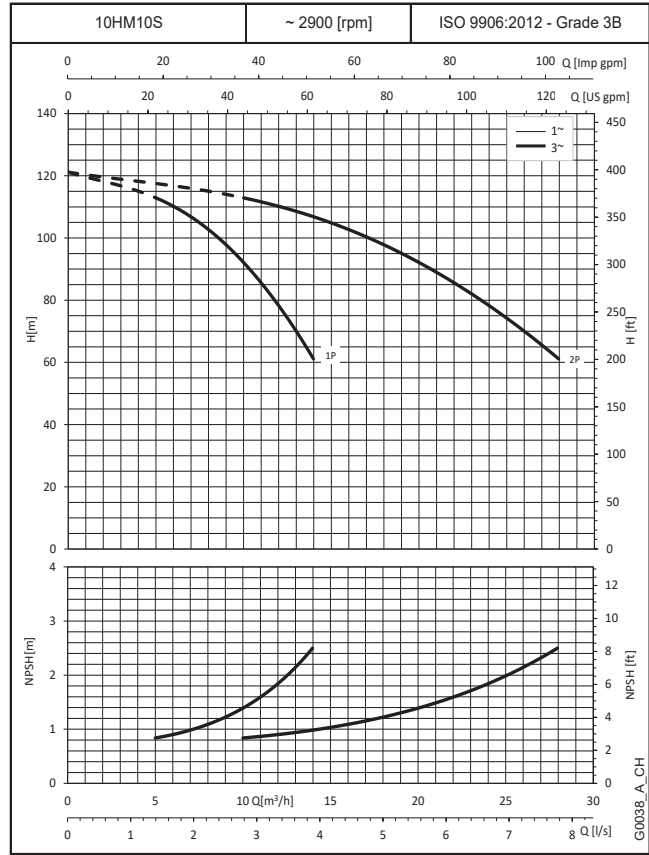
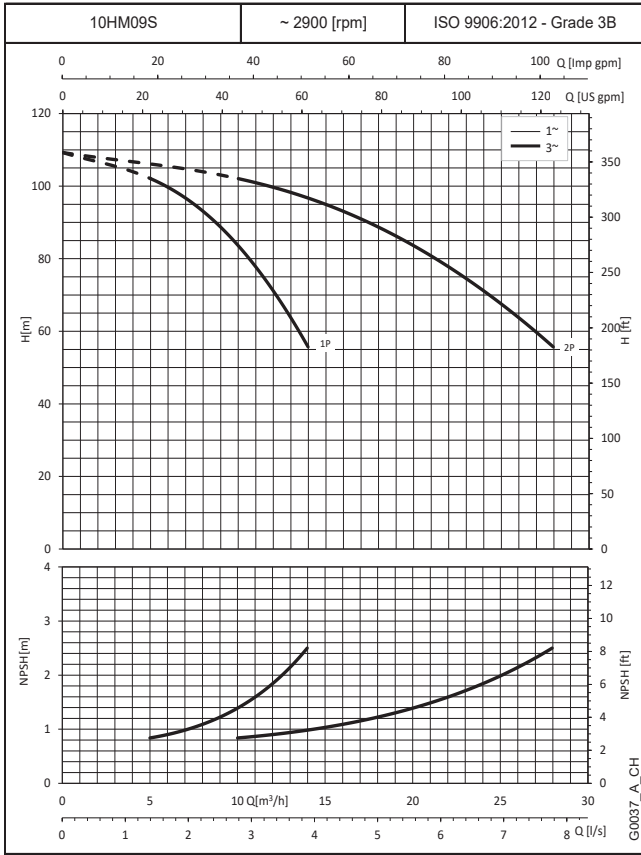

The performance curves do not take into account flow resistance in the valves and piping.
The curves show the performance with one and two pumps running.
These performances are valid for liquids with density $\rho = 1.0 \text{ kg/dm}^3$ and kinematic viscosity $\nu = 1 \text{ mm}^2/\text{sec}$.
The declared NPSH values are laboratory values; for practical use we recommend increasing these values by 0,5 m.

**BOOSTER SETS GX5 AND GMD SERIES
OPERATING CHARACTERISTICS AT 50 Hz**

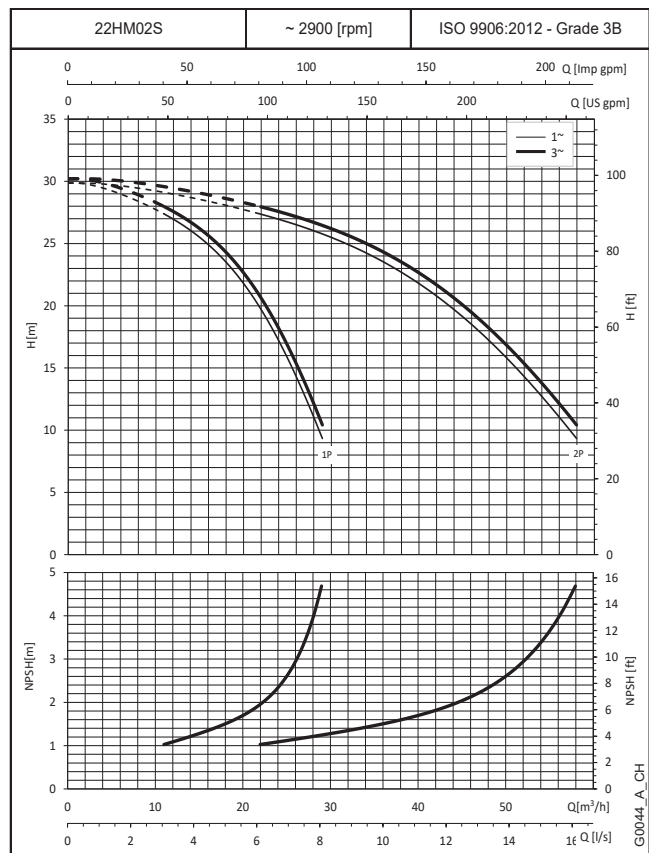
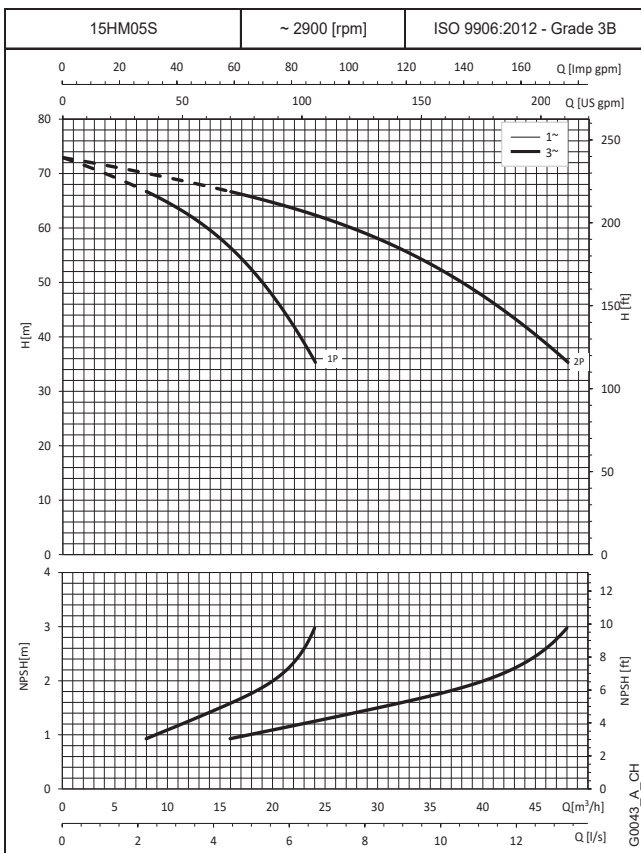
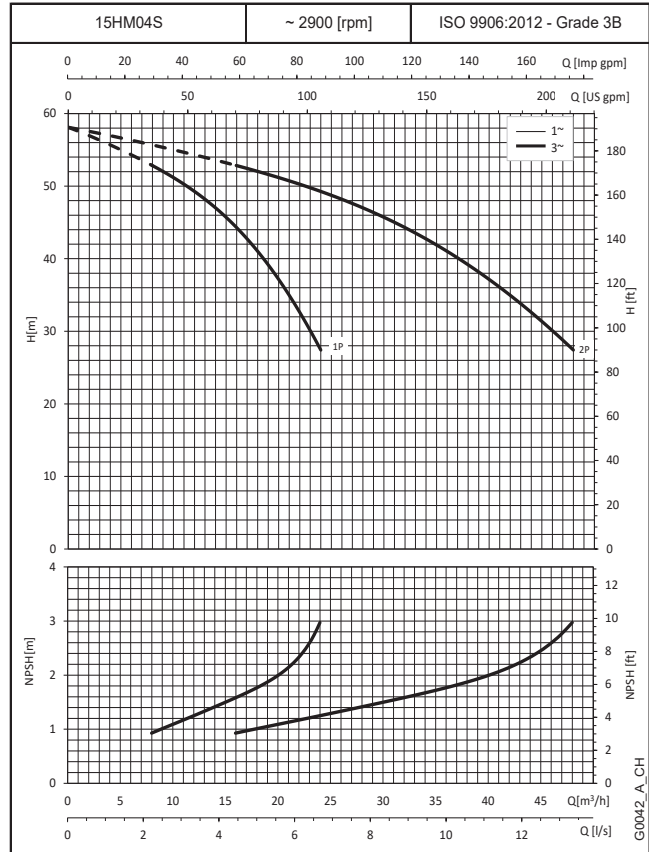
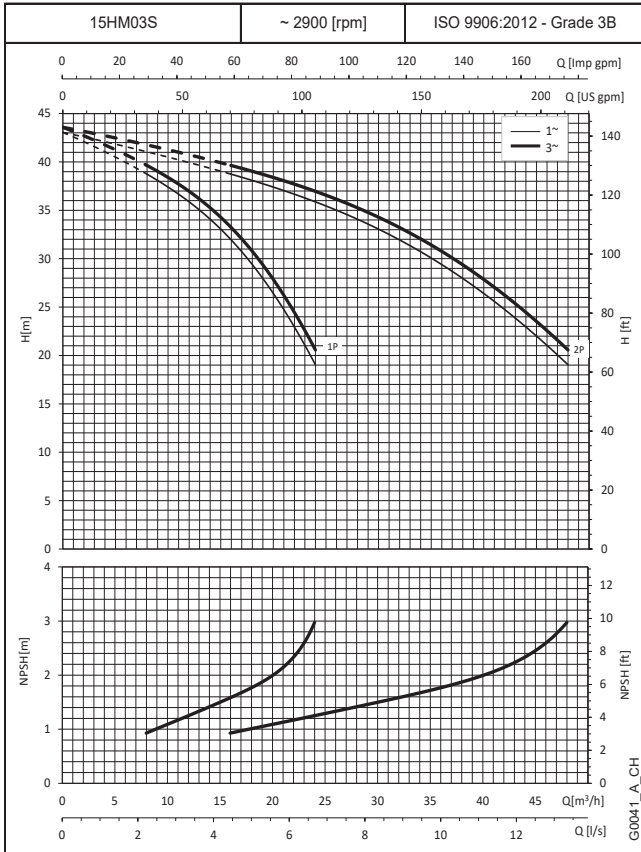

The performance curves do not take into account flow resistance in the valves and piping.
The curves show the performance with one and two pumps running.
These performances are valid for liquids with density $\rho = 1.0 \text{ kg/dm}^3$ and kinematic viscosity $\nu = 1 \text{ mm}^2/\text{sec}$.
The declared NPSH values are laboratory values: for practical use we recommend increasing these values by 0,5 m.

BOOSTER SETS GX5 AND GMD SERIES OPERATING CHARACTERISTICS AT 50 Hz

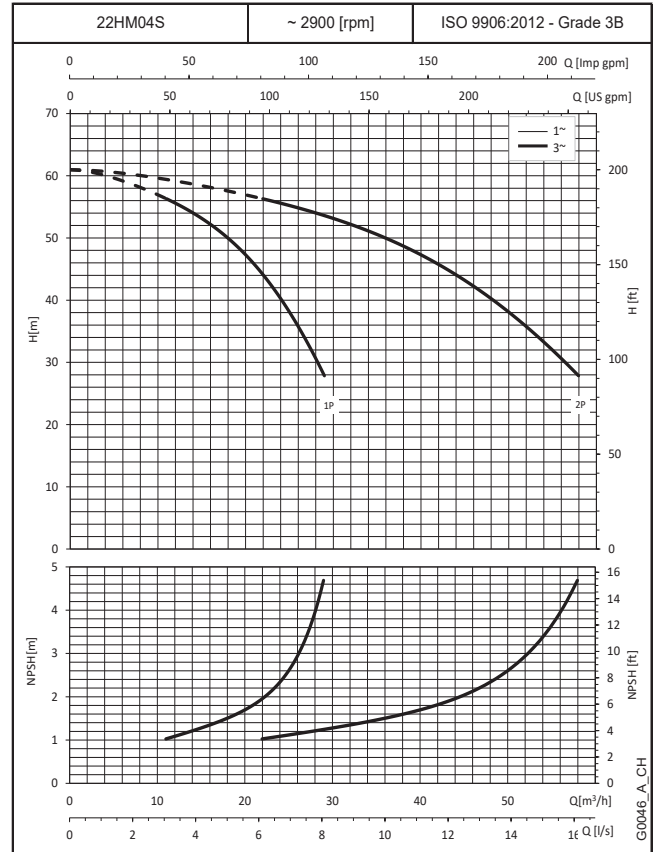
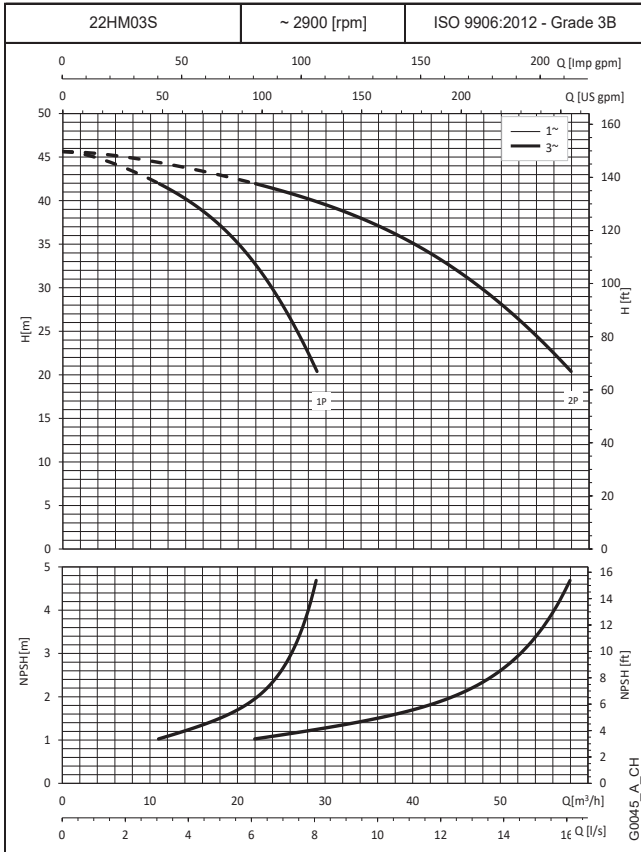

The performance curves do not take into account flow resistance in the valves and piping.
 The curves show the performance with one and two pumps running.
 These performances are valid for liquids with density $\rho = 1.0 \text{ kg/dm}^3$ and kinematic viscosity $\nu = 1 \text{ mm}^2/\text{sec}$.
 The declared NPSH values are laboratory values: for practical use we recommend increasing these values by 0,5 m.

BOOSTER SETS GX5 AND GMD SERIES OPERATING CHARACTERISTICS AT 50 Hz

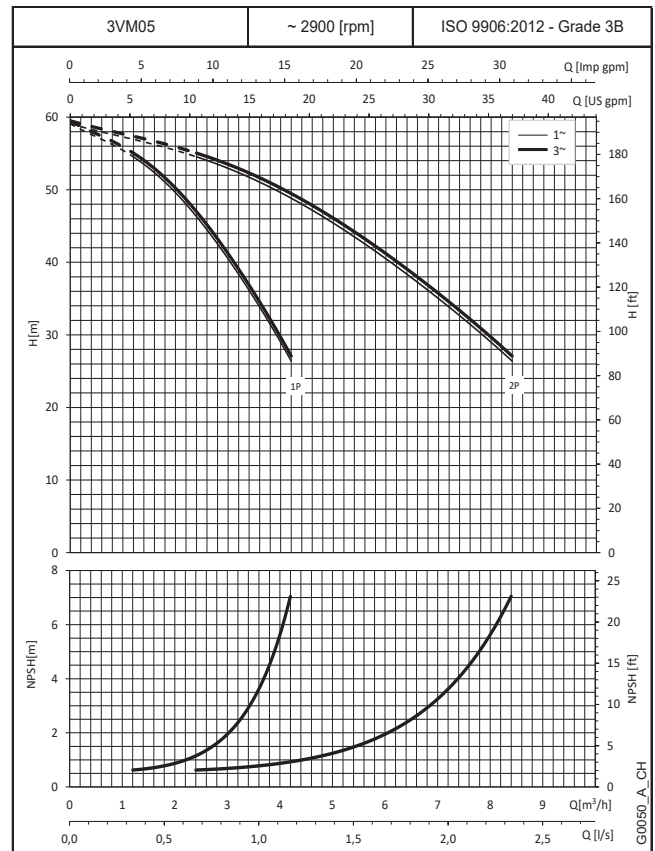
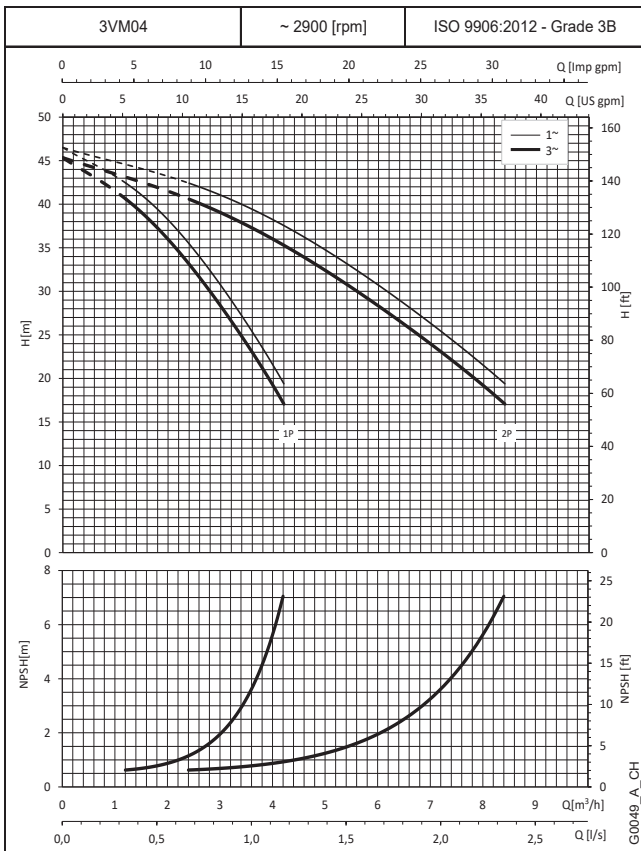
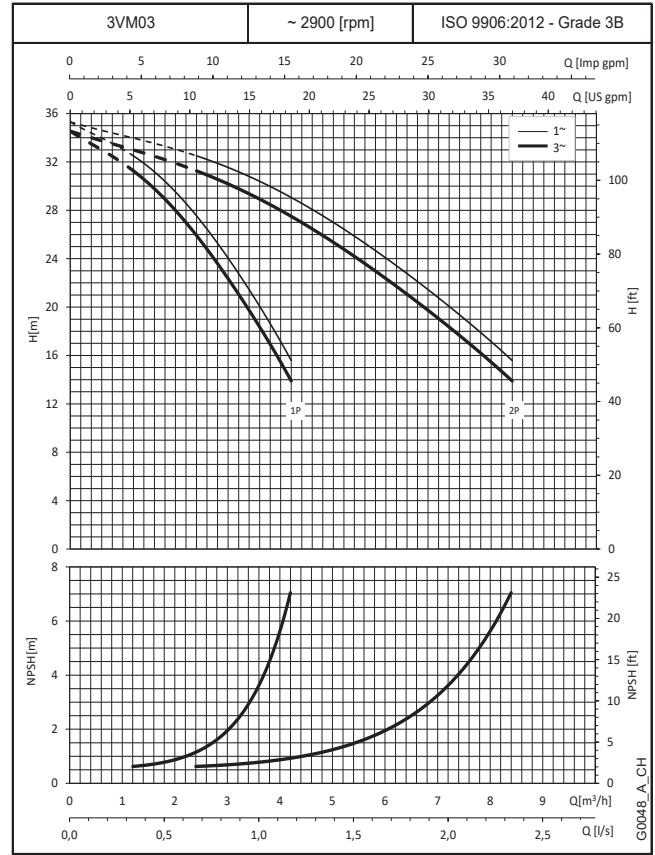
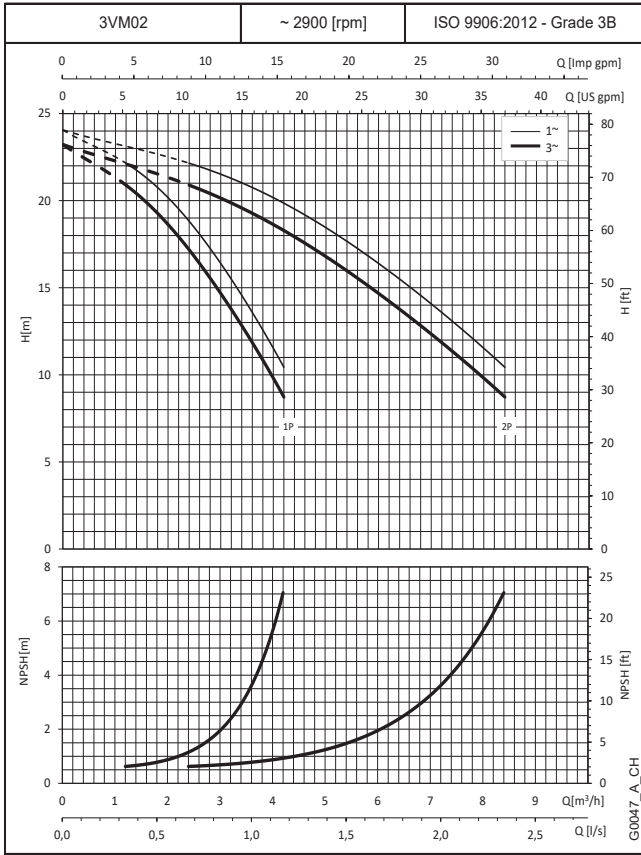

The performance curves do not take into account flow resistance in the valves and piping.
 The curves show the performance with one and two pumps running.
 These performances are valid for liquids with density $\rho = 1.0 \text{ kg/dm}^3$ and kinematic viscosity $\nu = 1 \text{ mm}^2/\text{sec}$.
 The declared NPSH values are laboratory values: for practical use we recommend increasing these values by 0,5 m.

BOOSTER SETS GX5 AND GMD SERIES OPERATING CHARACTERISTICS AT 50 Hz

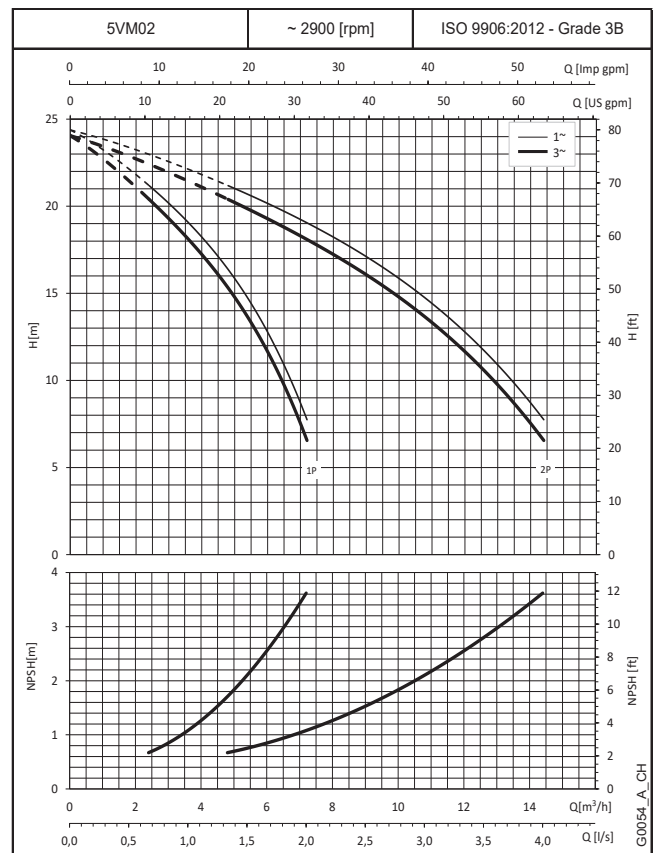
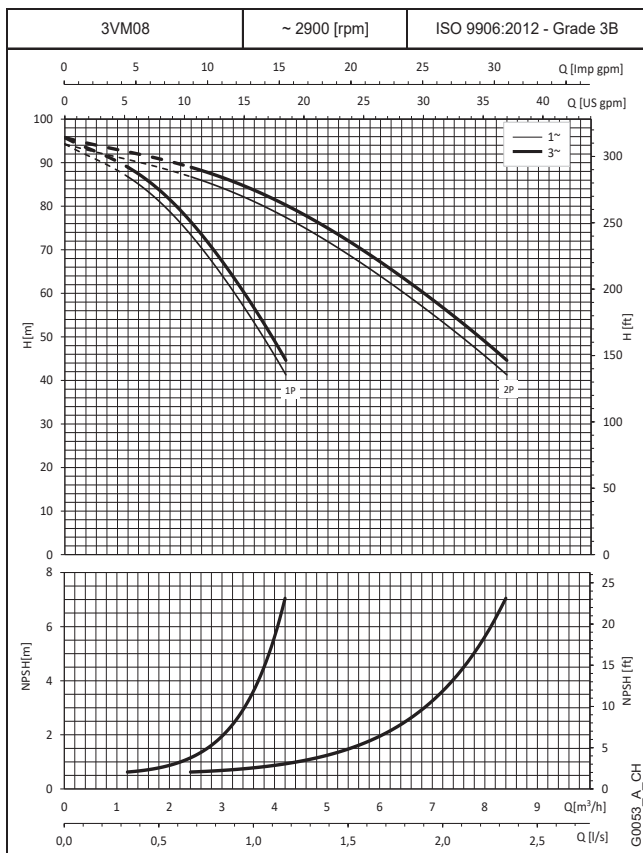
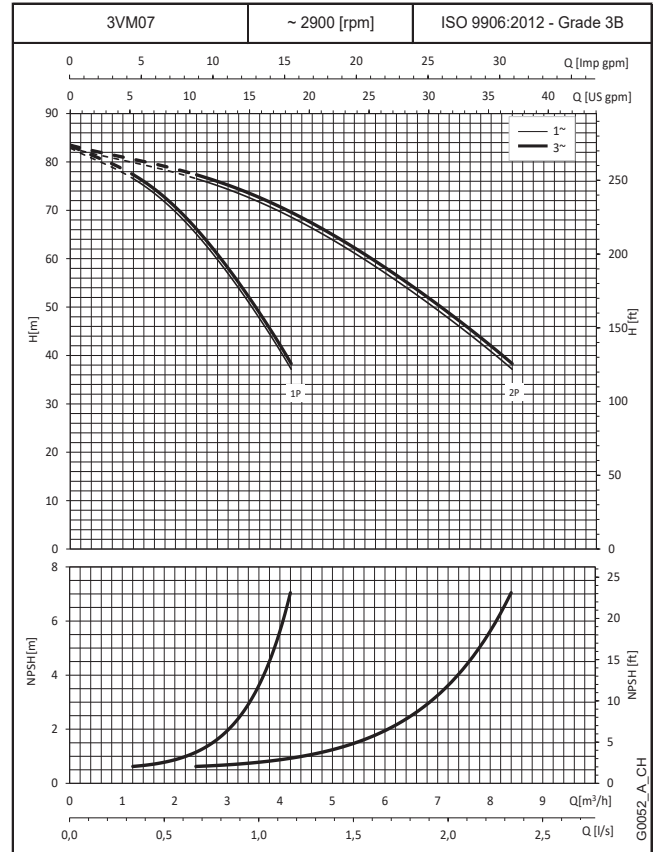
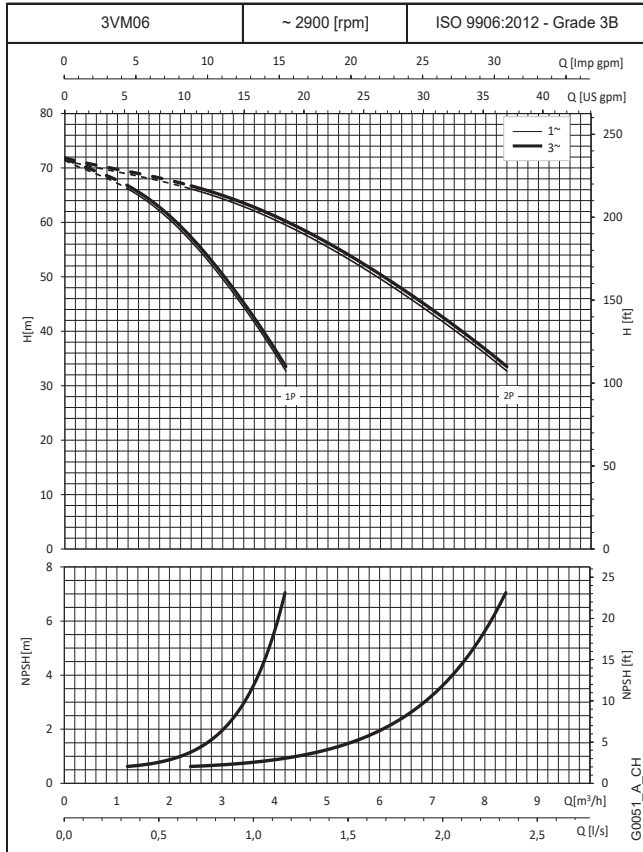

The performance curves do not take into account flow resistance in the valves and piping.
 The curves show the performance with one and two pumps running.
 These performances are valid for liquids with density $\rho = 1.0 \text{ kg/dm}^3$ and kinematic viscosity $\nu = 1 \text{ mm}^2/\text{sec}$.
 The declared NPSH values are laboratory values: for practical use we recommend increasing these values by 0,5 m.

BOOSTER SETS GX5 AND GMD SERIES OPERATING CHARACTERISTICS AT 50 Hz

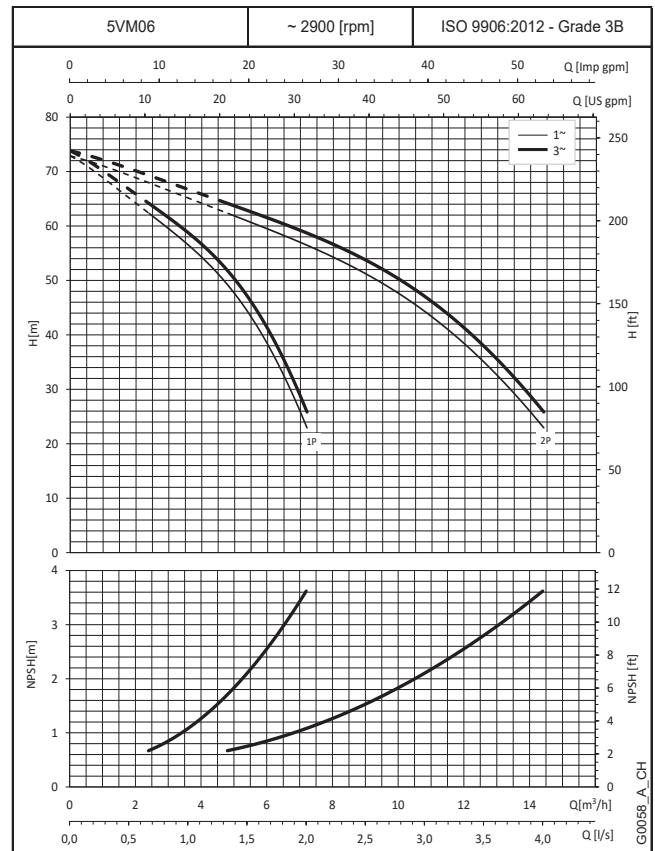
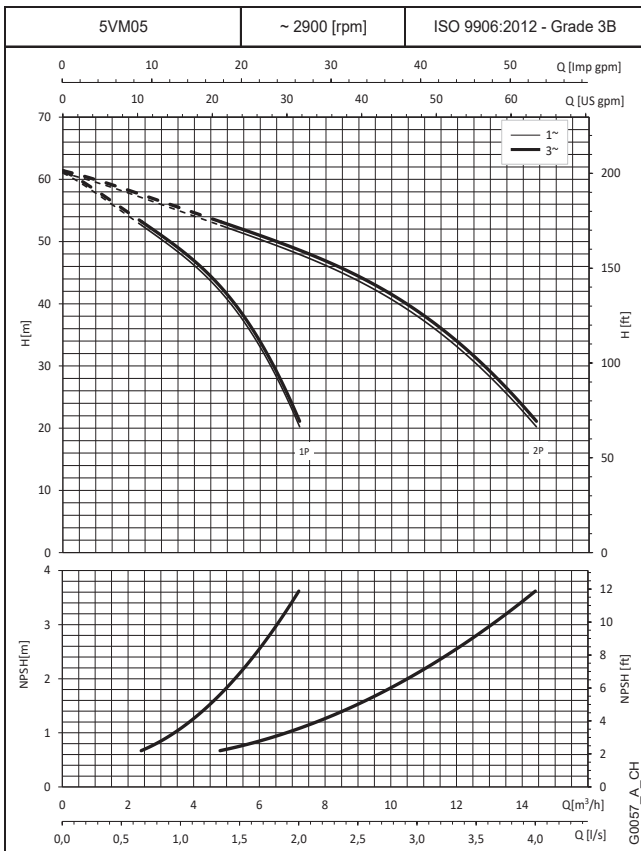
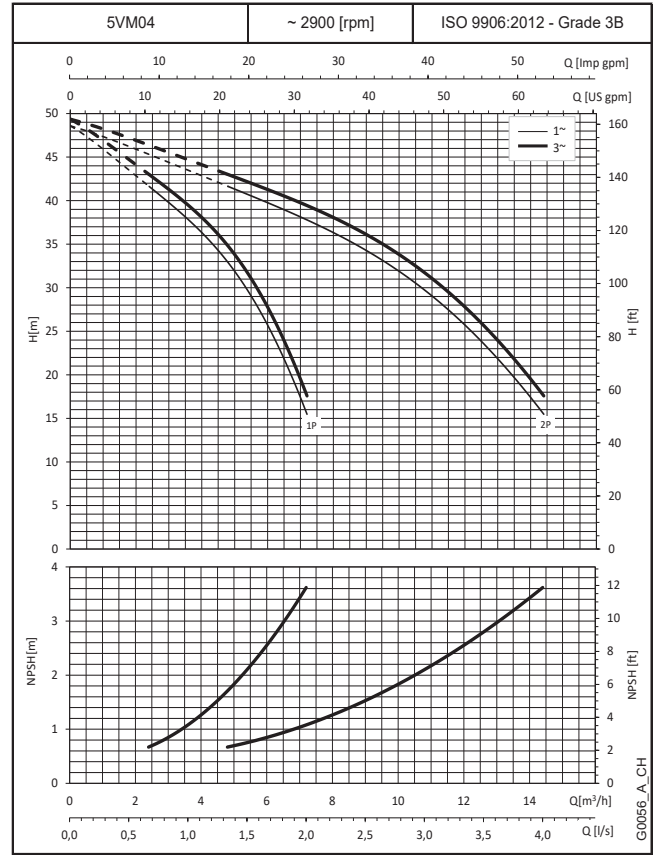
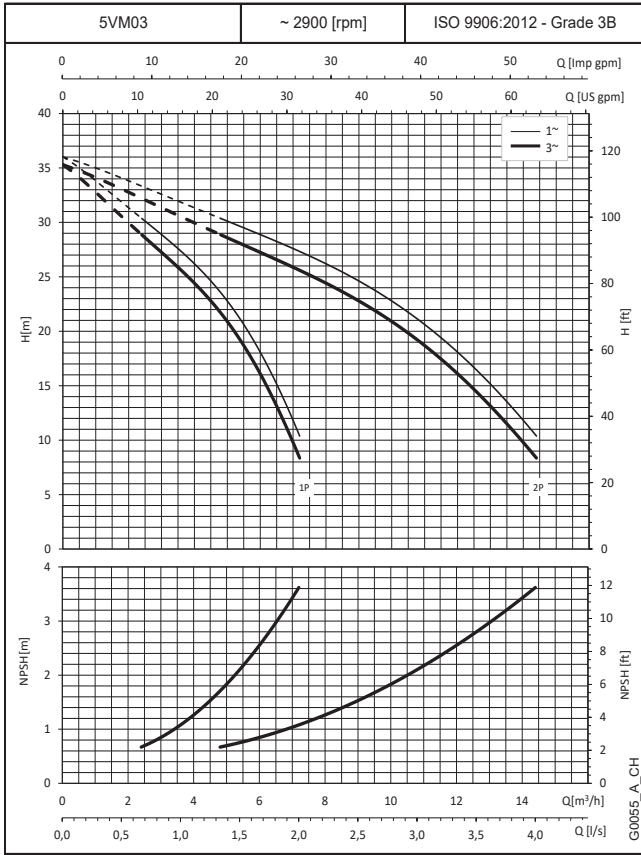

The performance curves do not take into account flow resistance in the valves and piping.
 The curves show the performance with one and two pumps running.
 These performances are valid for liquids with density $\rho = 1.0 \text{ kg/dm}^3$ and kinematic viscosity $\nu = 1 \text{ mm}^2/\text{sec}$.
 The declared NPSH values are laboratory values: for practical use we recommend increasing these values by 0,5 m.

BOOSTER SETS GX5 AND GMD SERIES OPERATING CHARACTERISTICS AT 50 Hz

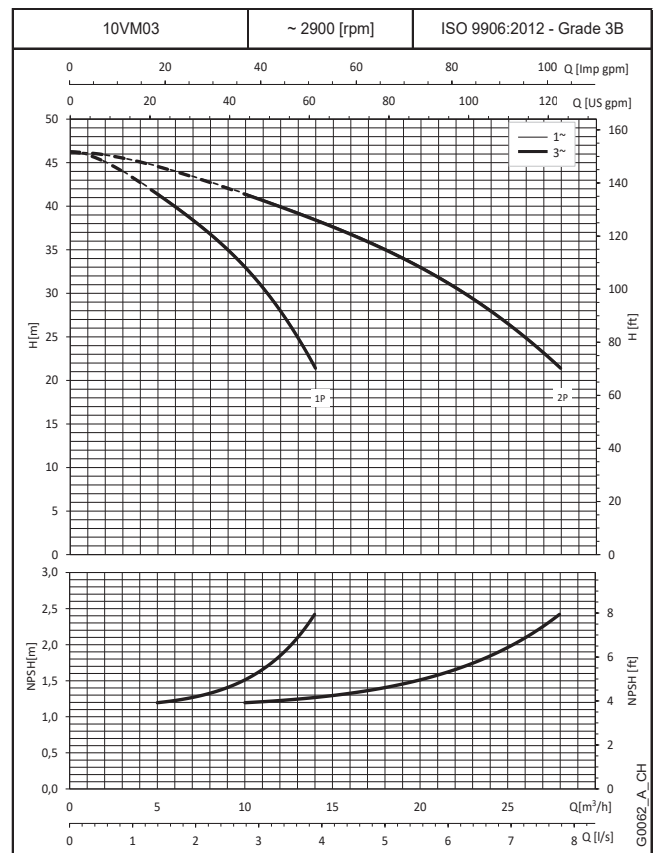
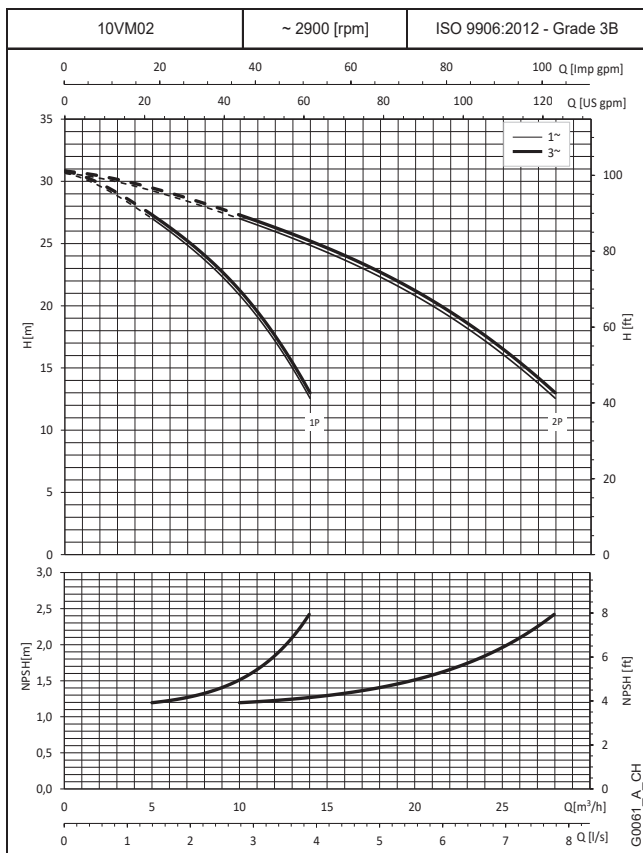
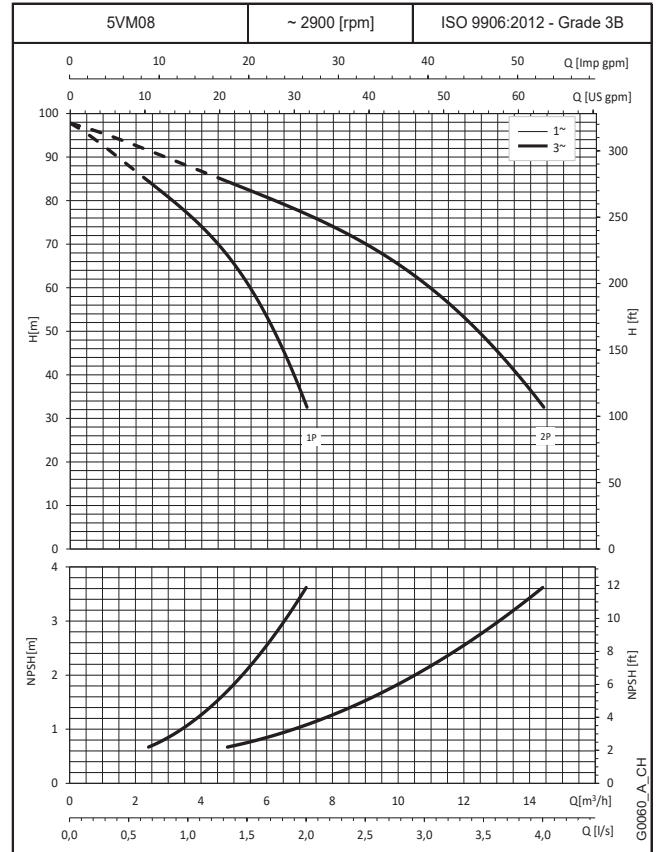
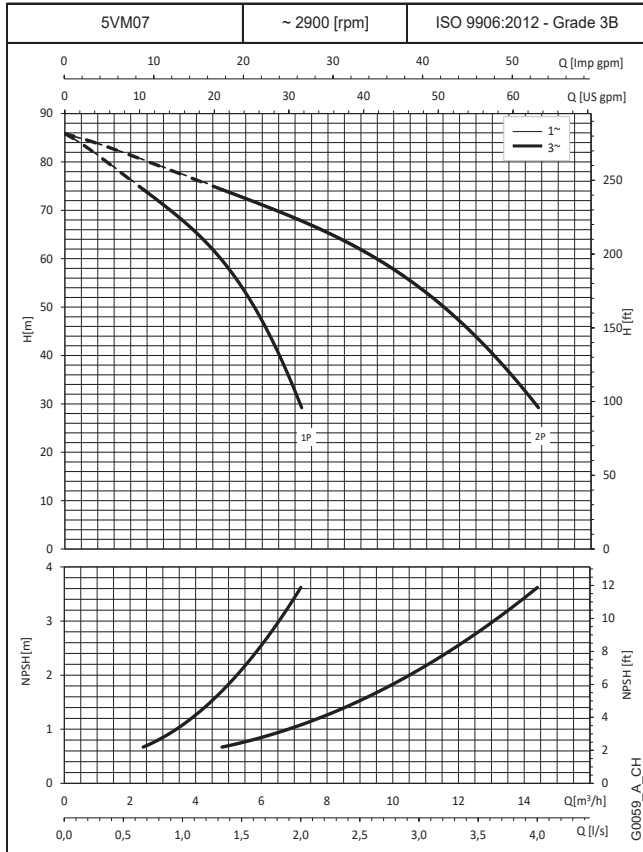

The performance curves do not take into account flow resistance in the valves and piping.
The curves show the performance with one and two pumps running.

These performances are valid for liquids with density $\rho = 1.0 \text{ kg/dm}^3$ and kinematic viscosity $\nu = 1 \text{ mm}^2/\text{sec}$.

The declared NPSH values are laboratory values; for practical use we recommend increasing these values by 0,5 m.

BOOSTER SETS GX5 AND GMD SERIES OPERATING CHARACTERISTICS AT 50 Hz

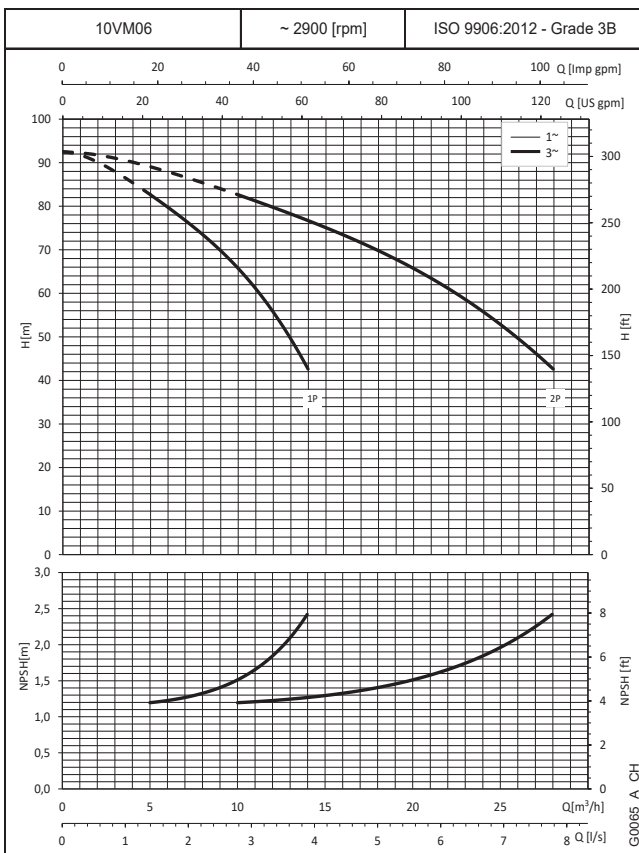
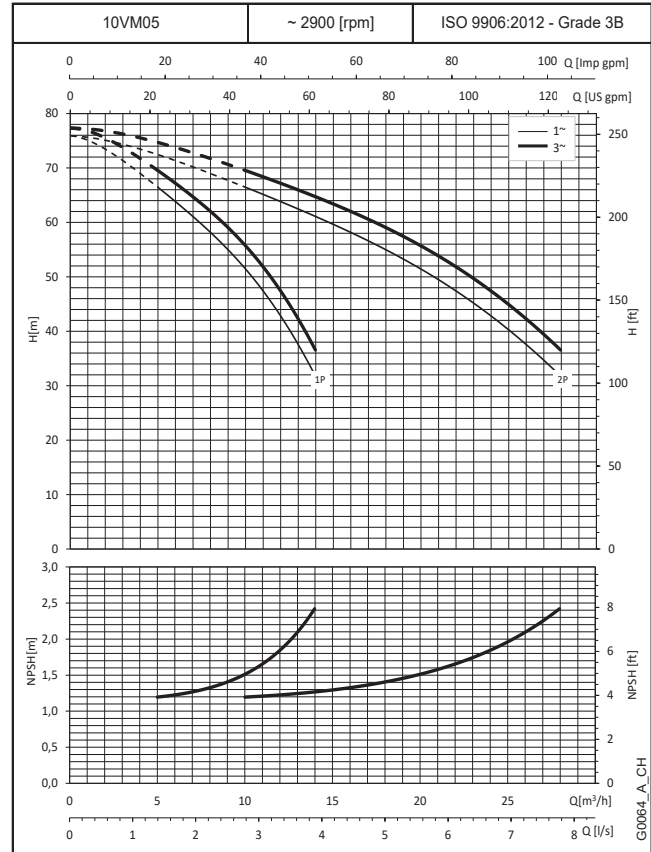
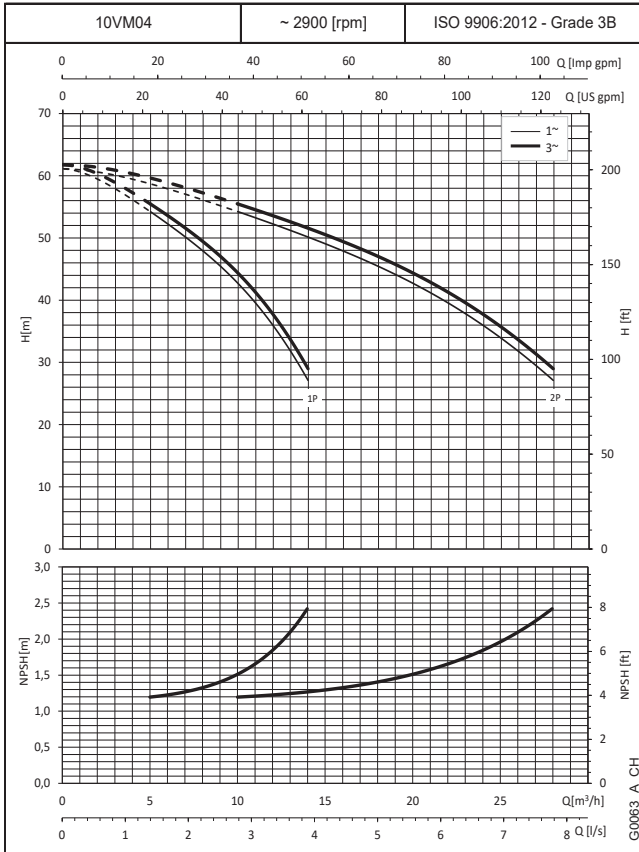

The performance curves do not take into account flow resistance in the valves and piping.
The curves show the performance with one and two pumps running.

These performances are valid for liquids with density $\rho = 1.0 \text{ kg/dm}^3$ and kinematic viscosity $\nu = 1 \text{ mm}^2/\text{sec}$.

The declared NPSH values are laboratory values: for practical use we recommend increasing these values by 0,5 m.

**BOOSTER SETS GX5 AND GMD SERIES
OPERATING CHARACTERISTICS AT 50 Hz**

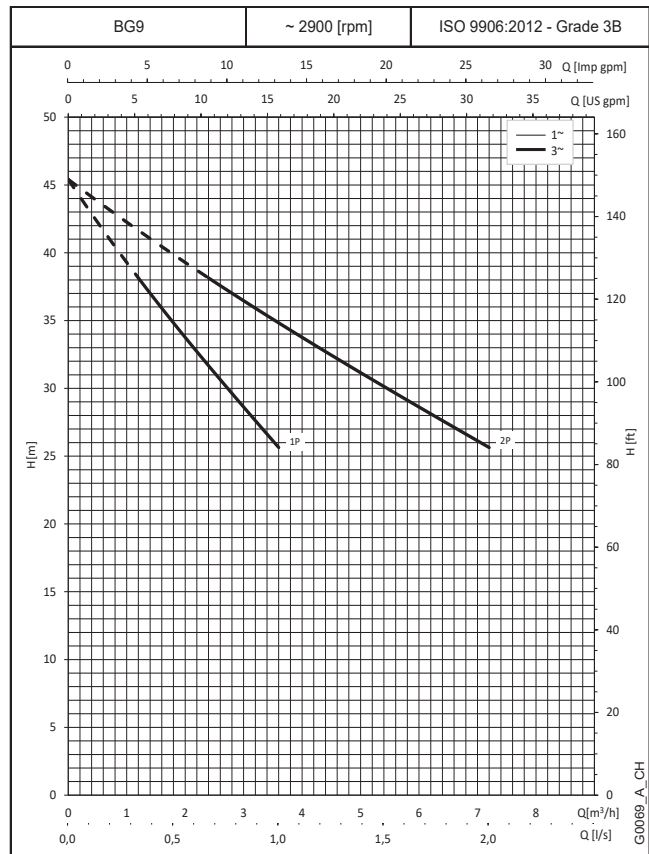
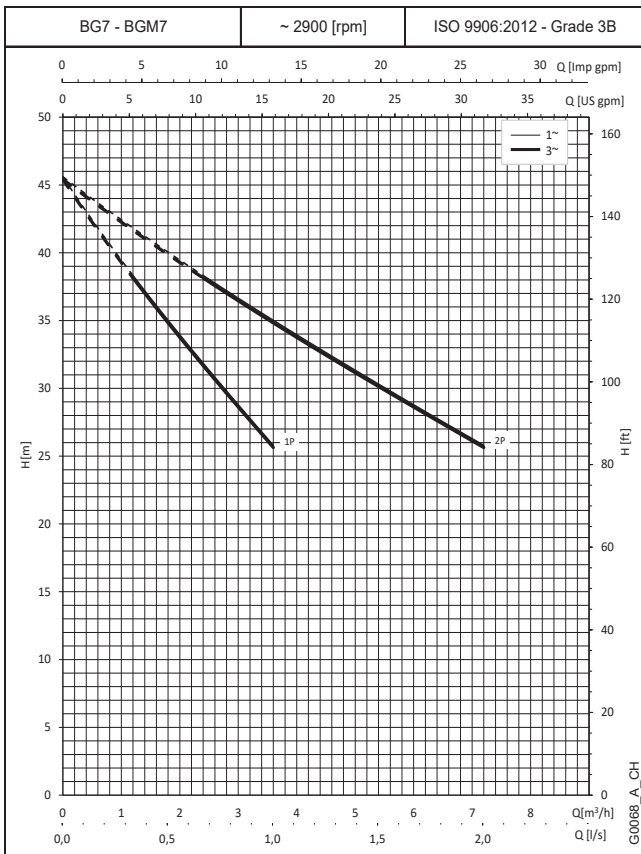
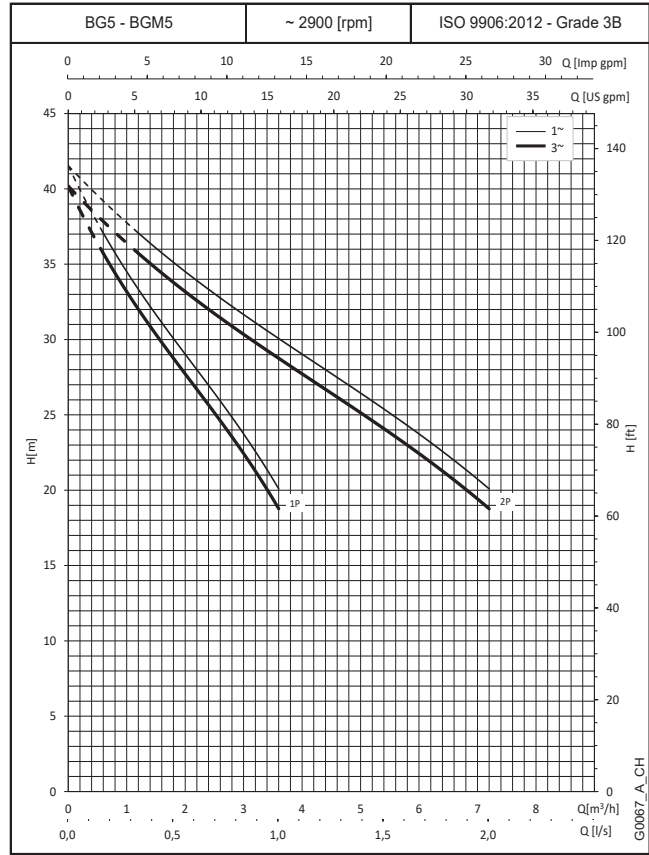
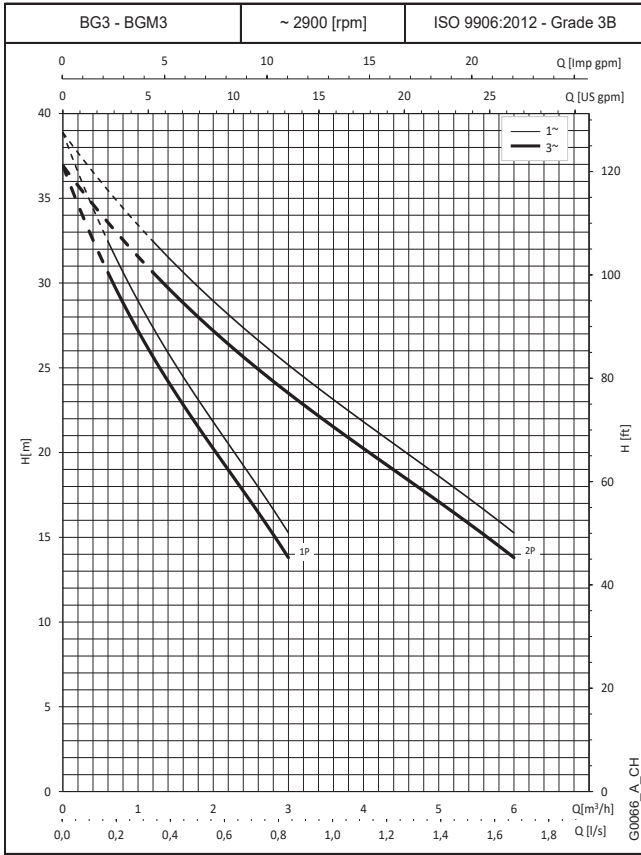

The performance curves do not take into account flow resistance in the valves and piping.
The curves show the performance with one and two pumps running.
These performances are valid for liquids with density $\rho = 1.0 \text{ kg/dm}^3$ and kinematic viscosity $\nu = 1 \text{ mm}^2/\text{sec}$.

**BOOSTER SETS GX5 AND GMD SERIES
OPERATING CHARACTERISTICS AT 50 Hz**

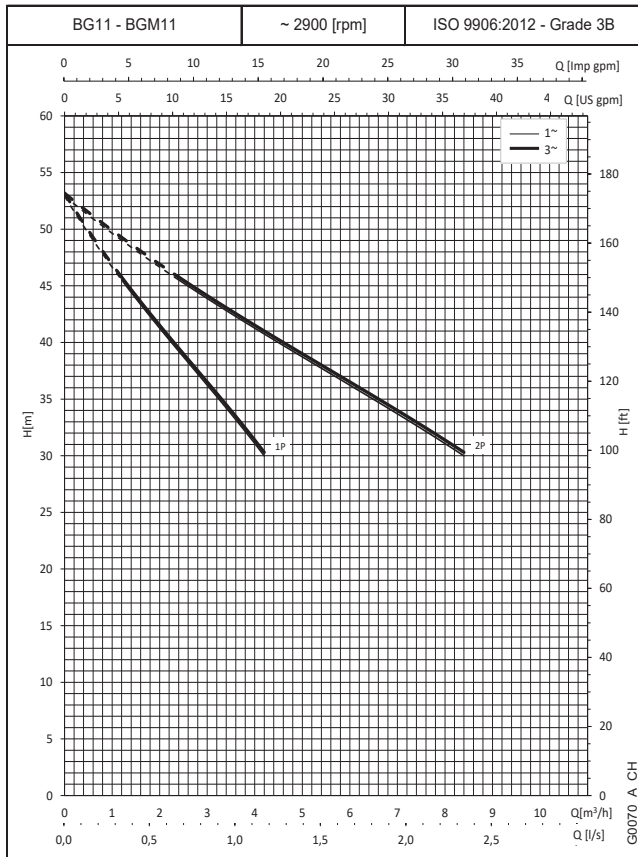

The performance curves do not take into account flow resistance in the valves and piping.
The curves show the performance with one and two pumps running.
These performances are valid for liquids with density $\rho = 1.0 \text{ kg/dm}^3$ and kinematic viscosity $\nu = 1 \text{ mm}^2/\text{sec}$.

BOOSTER SETS GX5 AND GMD SERIES OPERATING CHARACTERISTICS AT 50 Hz

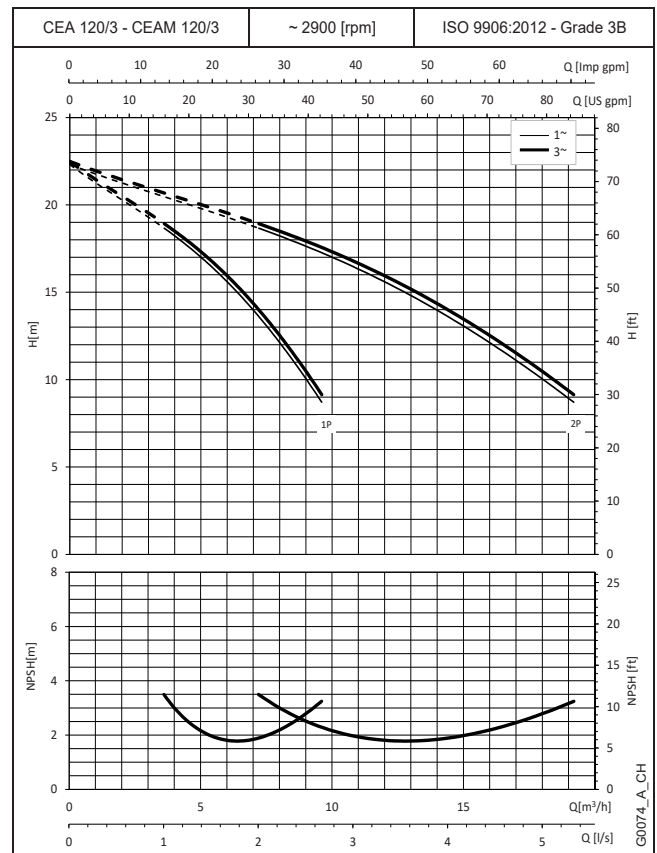
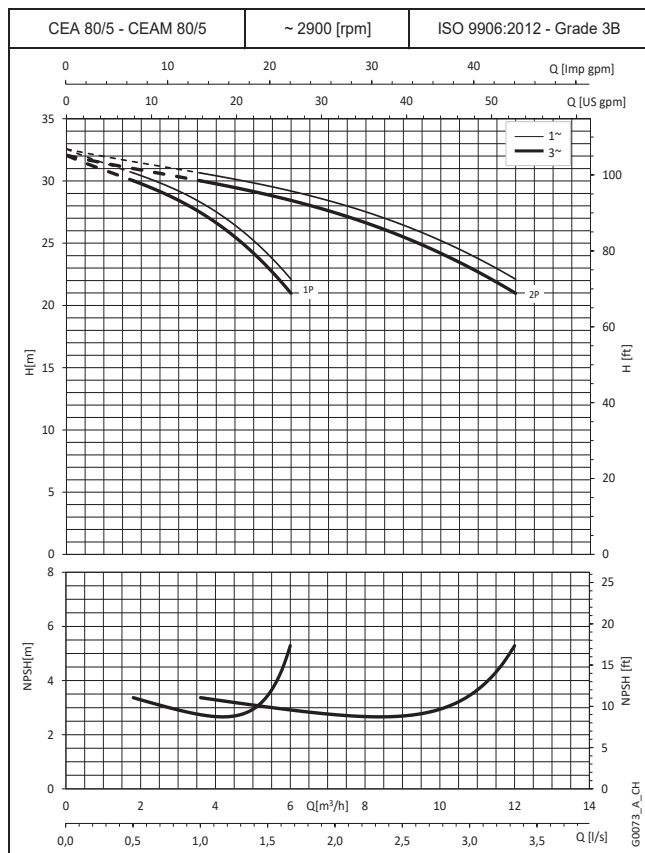
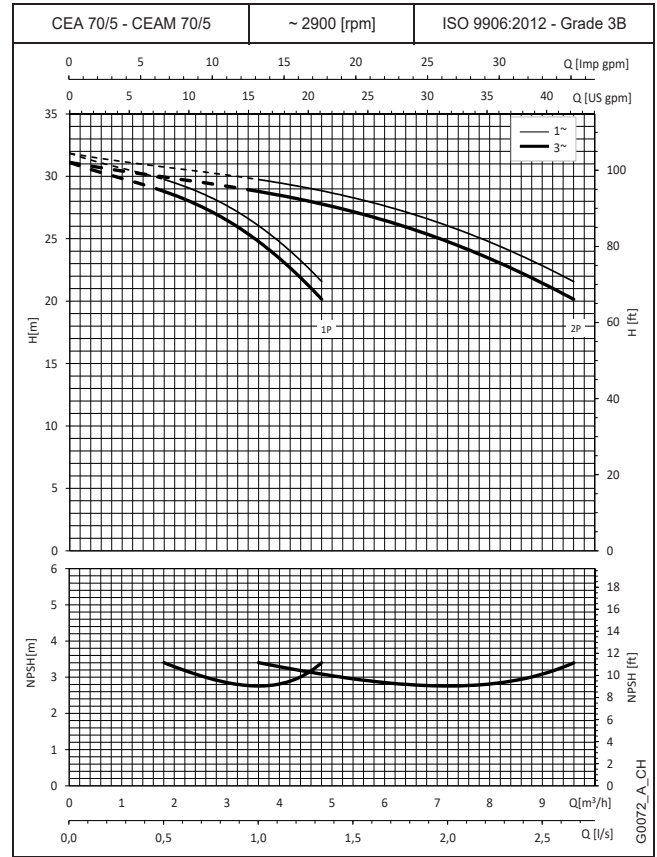
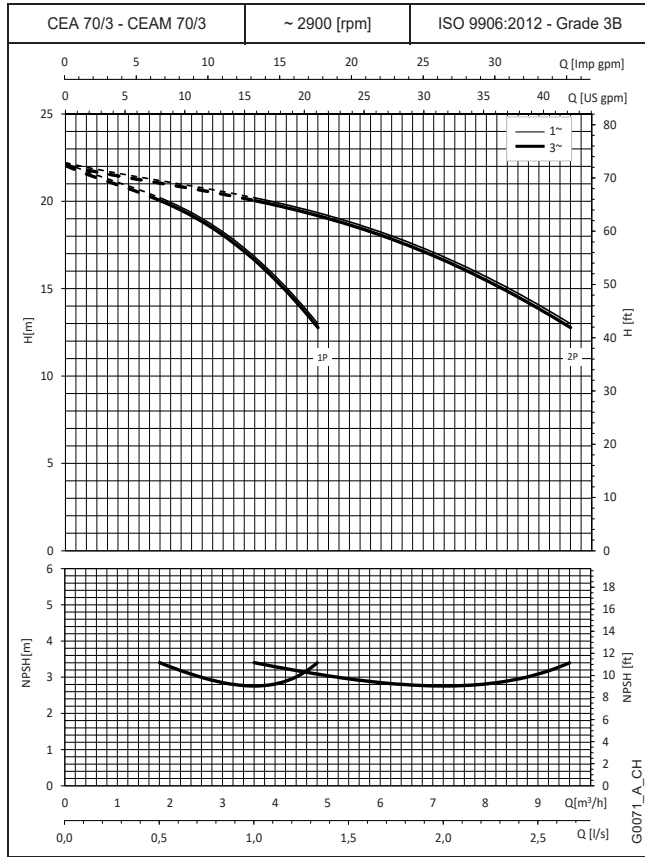

The performance curves do not take into account flow resistance in the valves and piping.
 The curves show the performance with one and two pumps running.
 These performances are valid for liquids with density $\rho = 1.0 \text{ kg/dm}^3$ and kinematic viscosity $\nu = 1 \text{ mm}^2/\text{sec}$.
 The declared NPSH values are laboratory values: for practical use we recommend increasing these values by 0,5 m.

BOOSTER SETS GX5 AND GMD SERIES OPERATING CHARACTERISTICS AT 50 Hz

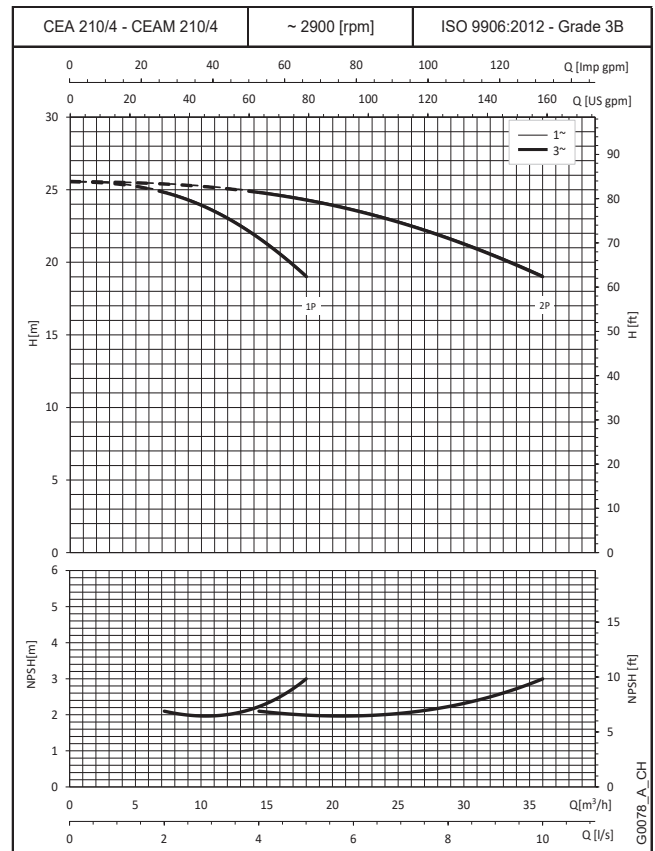
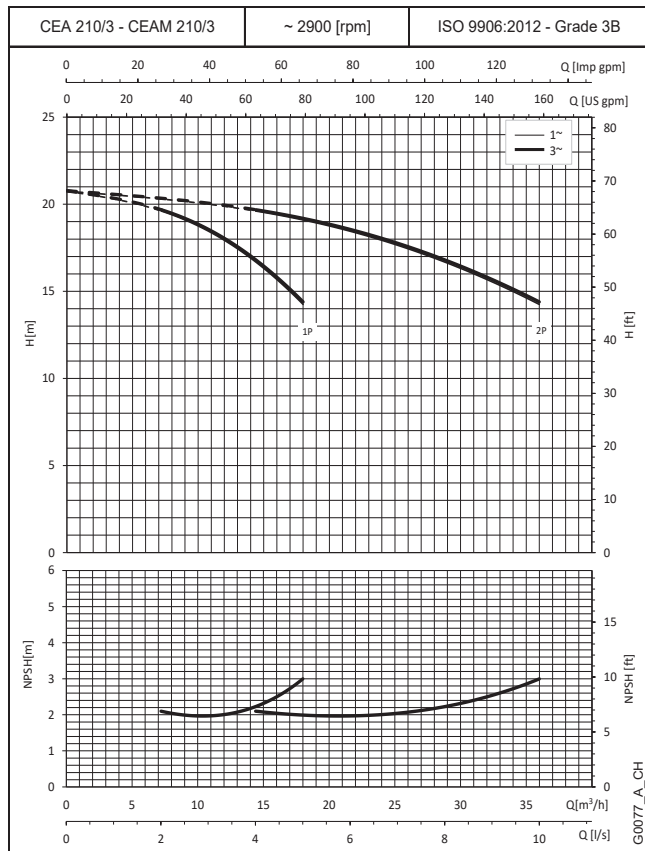
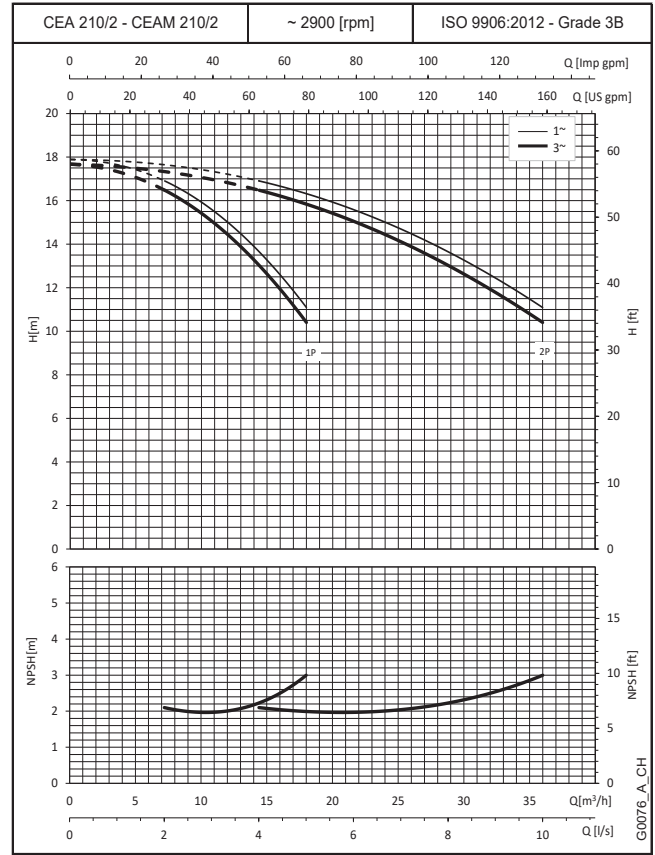
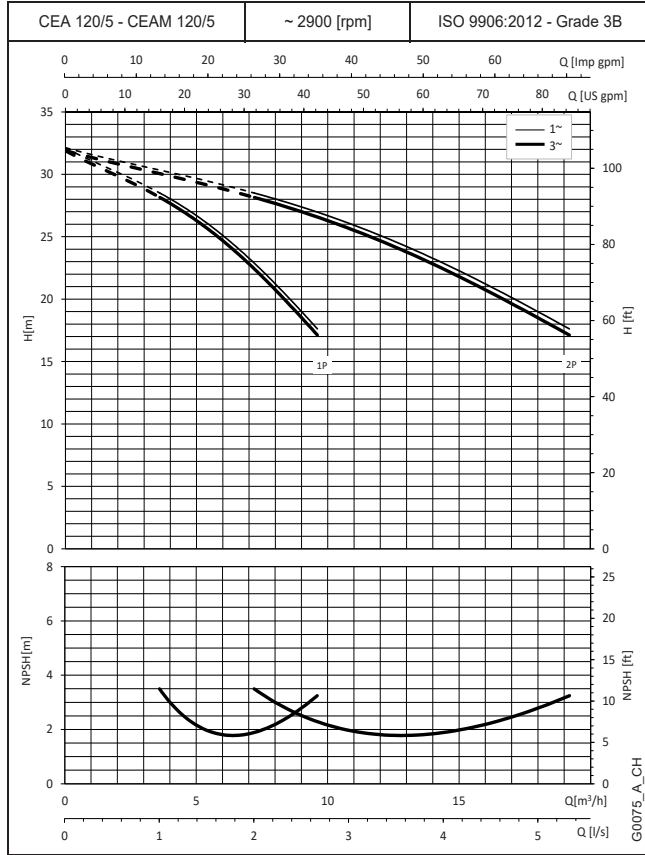

The performance curves do not take into account flow resistance in the valves and piping.
The curves show the performance with one and two pumps running.

These performances are valid for liquids with density $\rho = 1.0 \text{ kg/dm}^3$ and kinematic viscosity $\nu = 1 \text{ mm}^2/\text{sec}$.

The declared NPSH values are laboratory values: for practical use we recommend increasing these values by 0,5 m.

BOOSTER SETS GX5 AND GMD SERIES OPERATING CHARACTERISTICS AT 50 Hz

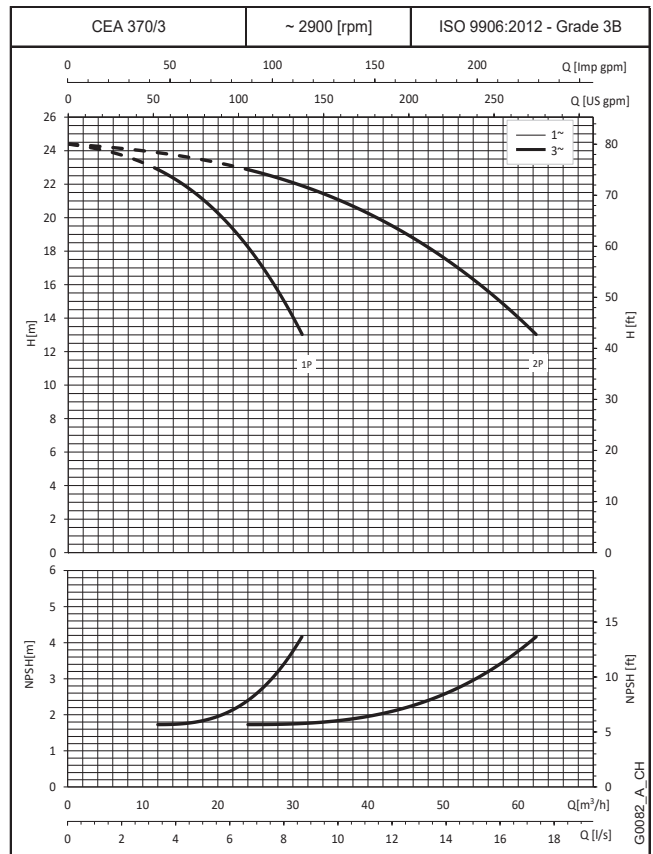
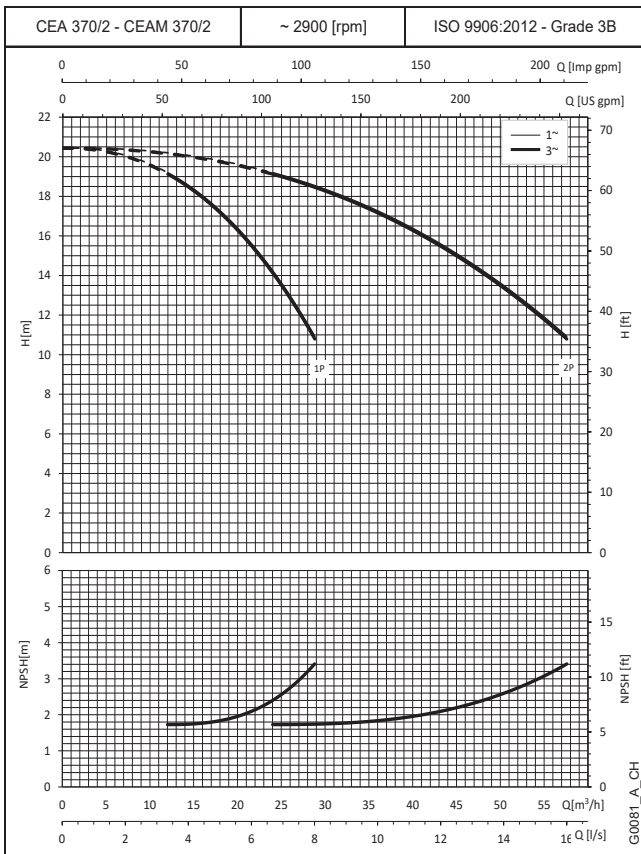
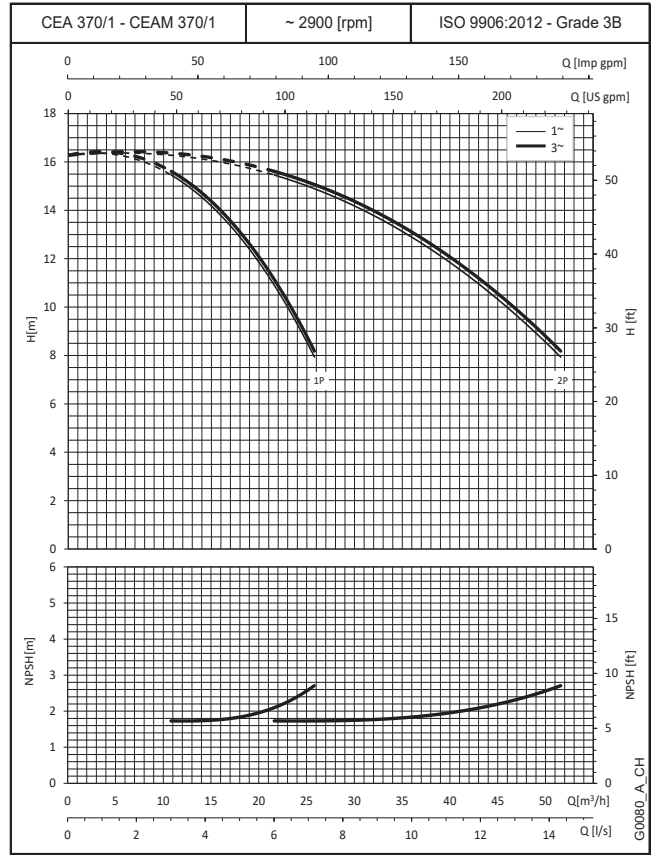
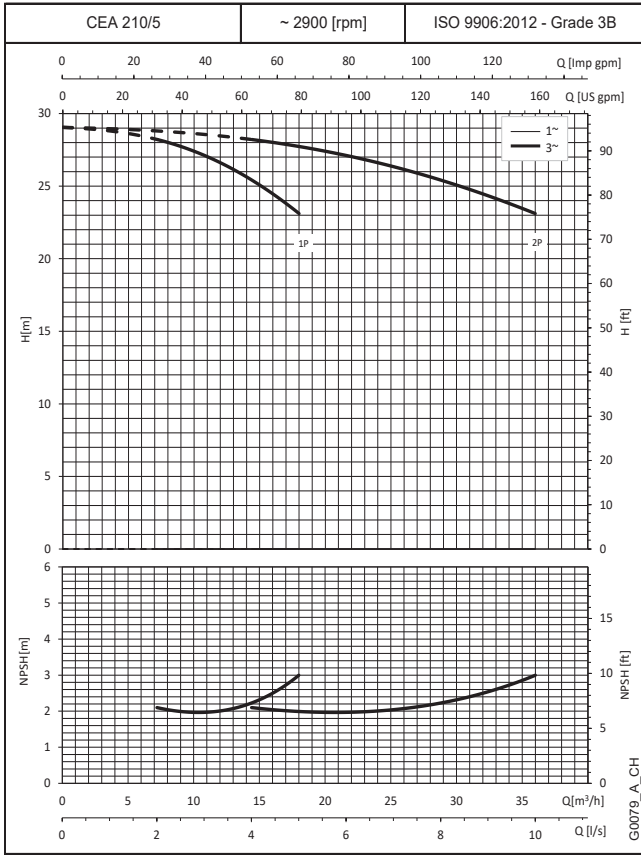

The performance curves do not take into account flow resistance in the valves and piping.

The curves show the performance with one and two pumps running.

These performances are valid for liquids with density $\rho = 1.0 \text{ kg/dm}^3$ and kinematic viscosity $\nu = 1 \text{ mm}^2/\text{sec}$.

The declared NPSH values are laboratory values: for practical use we recommend increasing these values by 0,5 m.

**BOOSTER SETS GXS AND GMD SERIES
OPERATING CHARACTERISTICS AT 50 Hz**

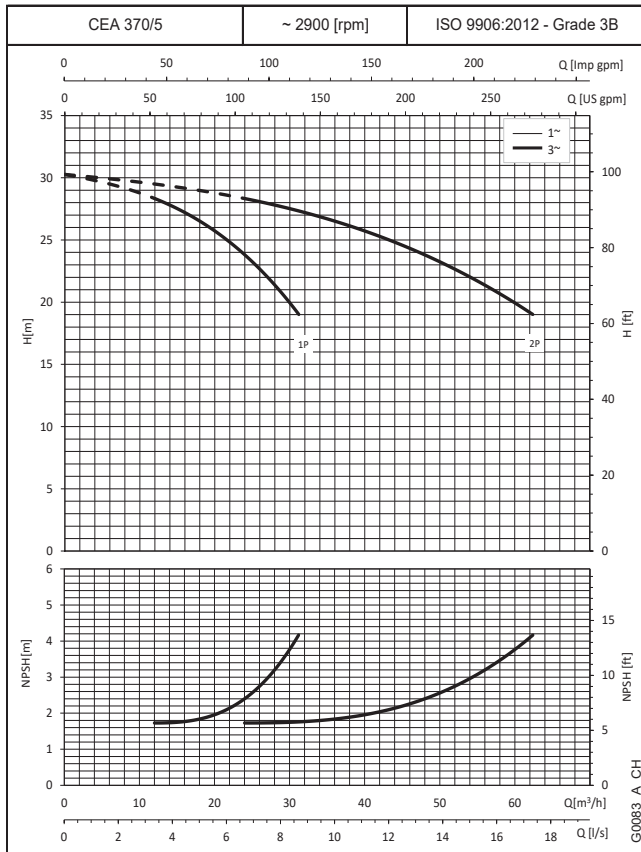

The performance curves do not take into account flow resistance in the valves and piping.
 The curves show the performance with one and two pumps running.
 These performances are valid for liquids with density $\rho = 1.0 \text{ kg/dm}^3$ and kinematic viscosity $\nu = 1 \text{ mm}^2/\text{sec}$.
 The declared NPSH values are laboratory values; for practical use we recommend increasing these values by 0,5 m.

BOOSTER SETS GX5 AND GMD SERIES OPERATING CHARACTERISTICS AT 50 Hz

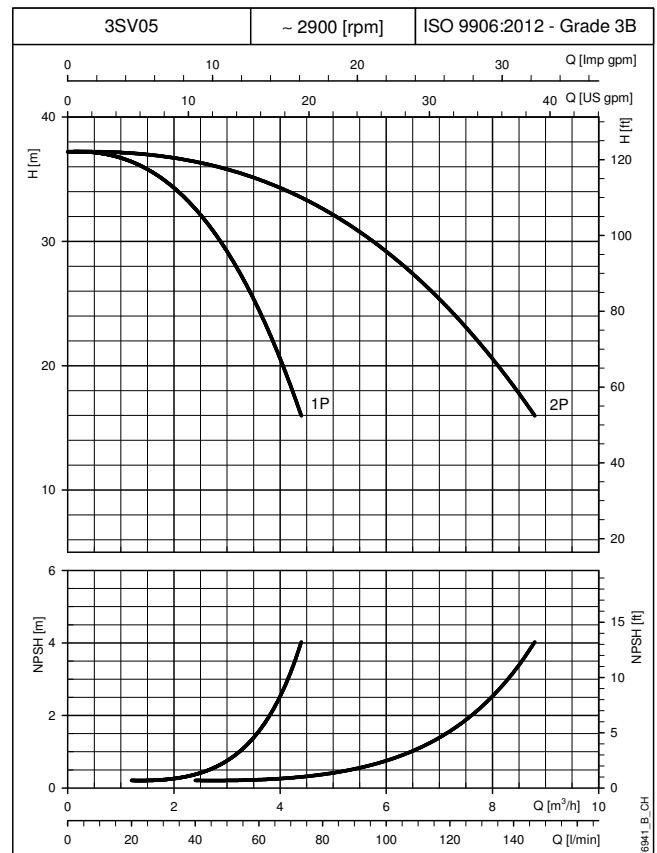
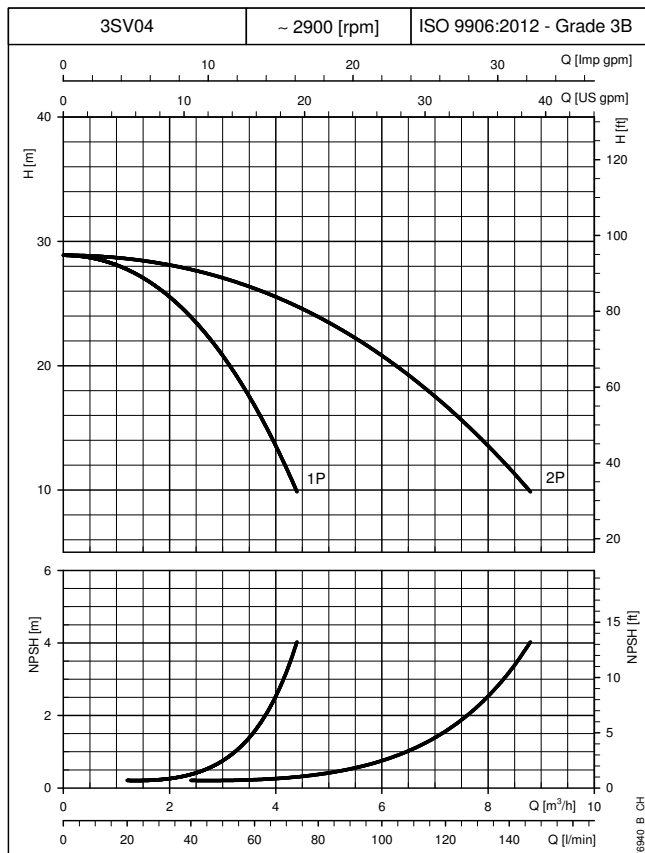
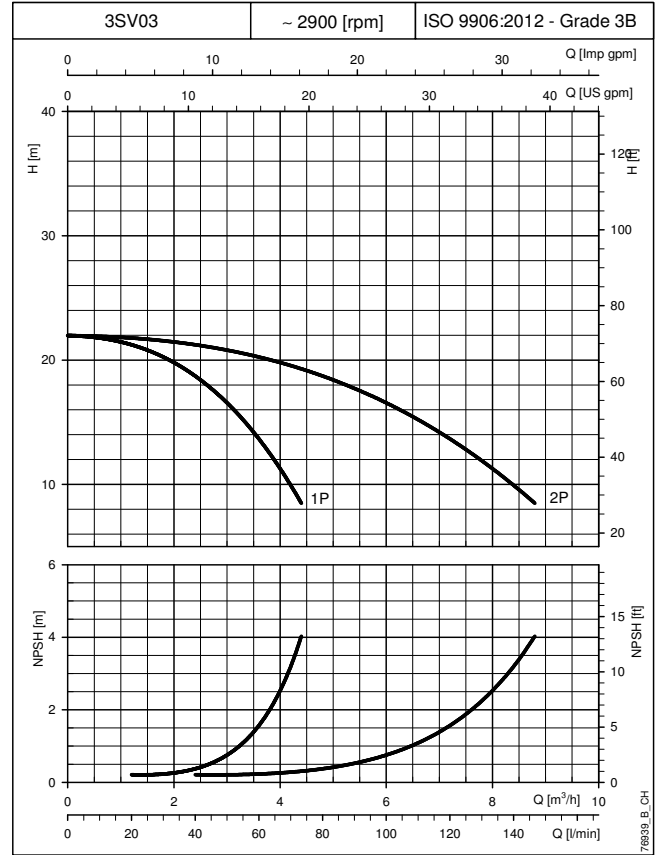
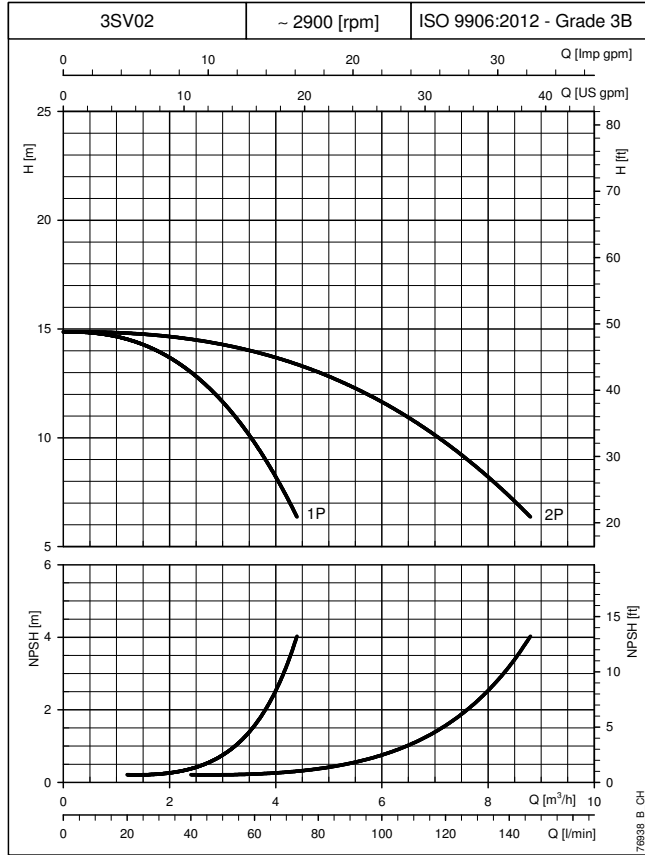

The performance curves do not take into account flow resistance in the valves and piping.
 The curves show the performance with one and two pumps running.
 These performances are valid for liquids with density $\rho = 1.0 \text{ kg/dm}^3$ and kinematic viscosity $\nu = 1 \text{ mm}^2/\text{sec}$.
 The declared NPSH values are laboratory values: for practical use we recommend increasing these values by 0,5 m.

BOOSTER SETS GX5 AND GMD SERIES OPERATING CHARACTERISTICS AT 50 Hz

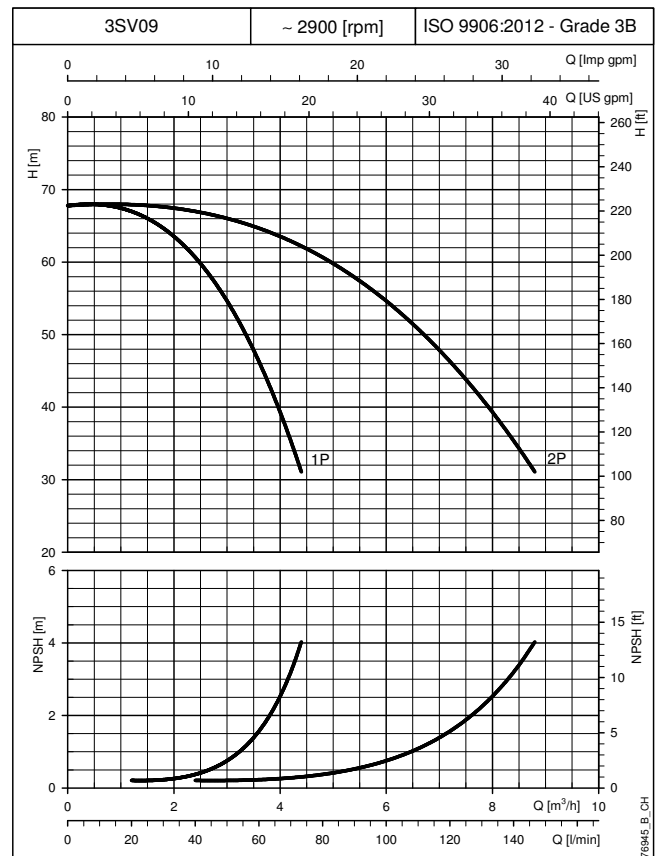
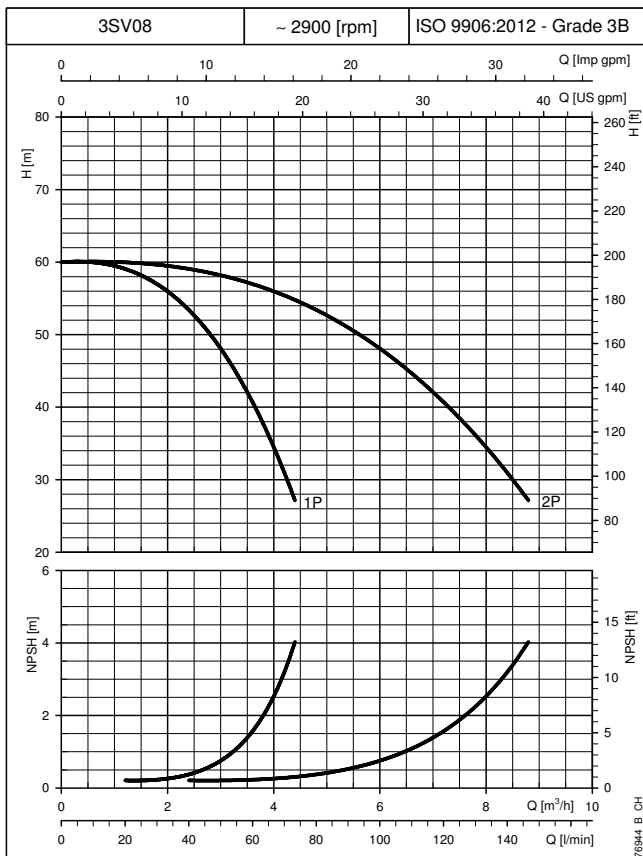
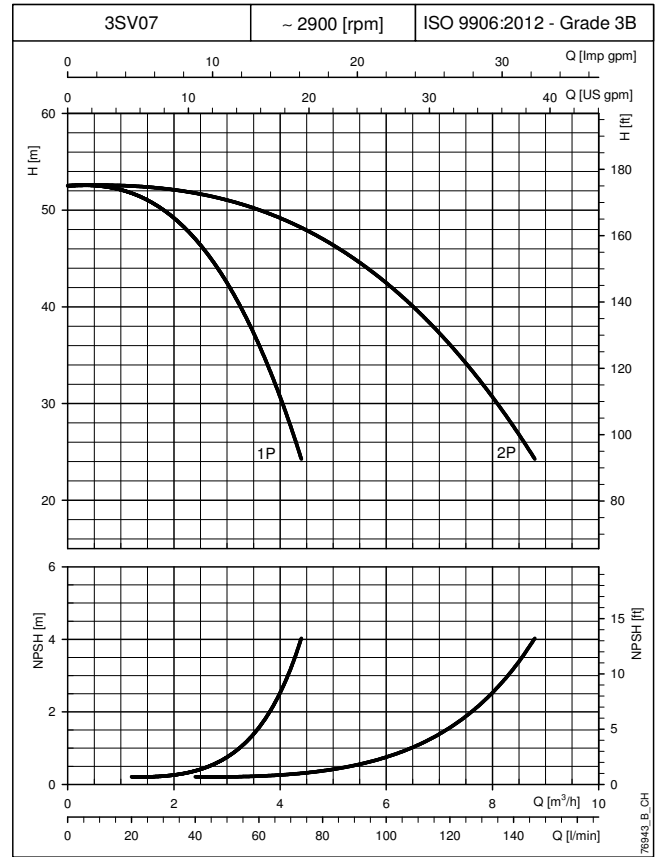
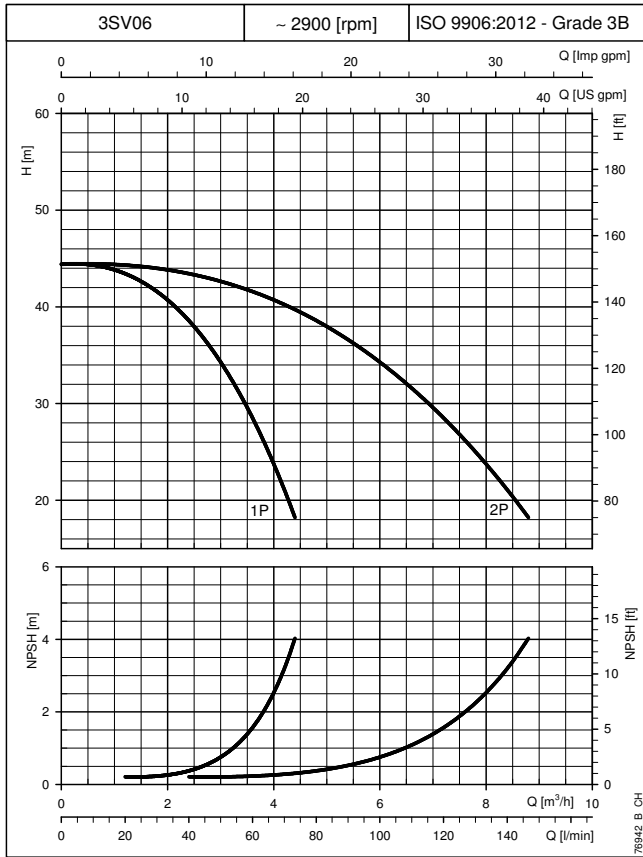

The performance curves do not take into account flow resistance in the valves and piping.
 The curves show the performance with one and two pumps running.
 These performances are valid for liquids with density $\rho = 1.0 \text{ kg/dm}^3$ and kinematic viscosity $\nu = 1 \text{ mm}^2/\text{sec}$.
 The declared NPSH values are laboratory values: for practical use we recommend increasing these values by 0,5 m.

BOOSTER SETS GX5 AND GMD SERIES OPERATING CHARACTERISTICS AT 50 Hz

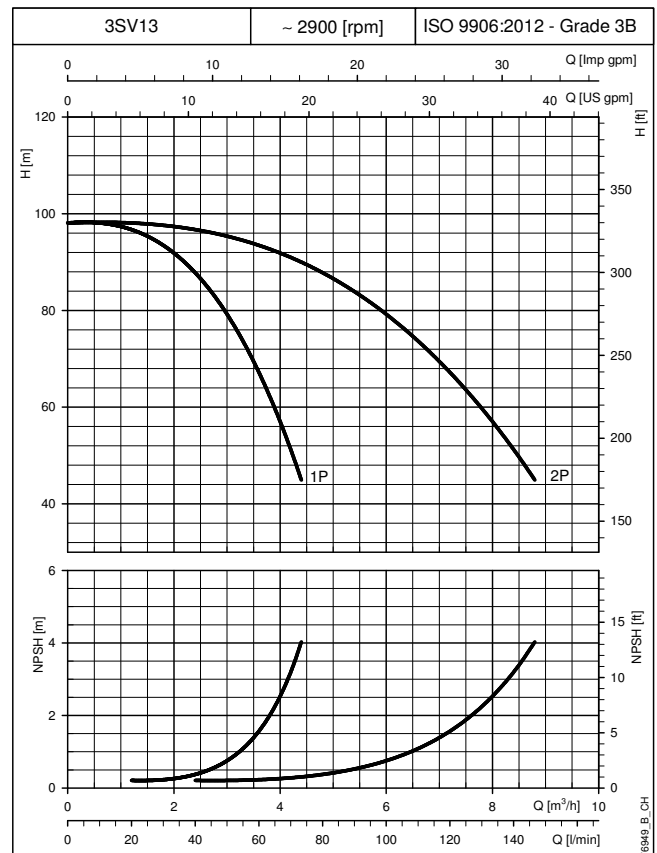
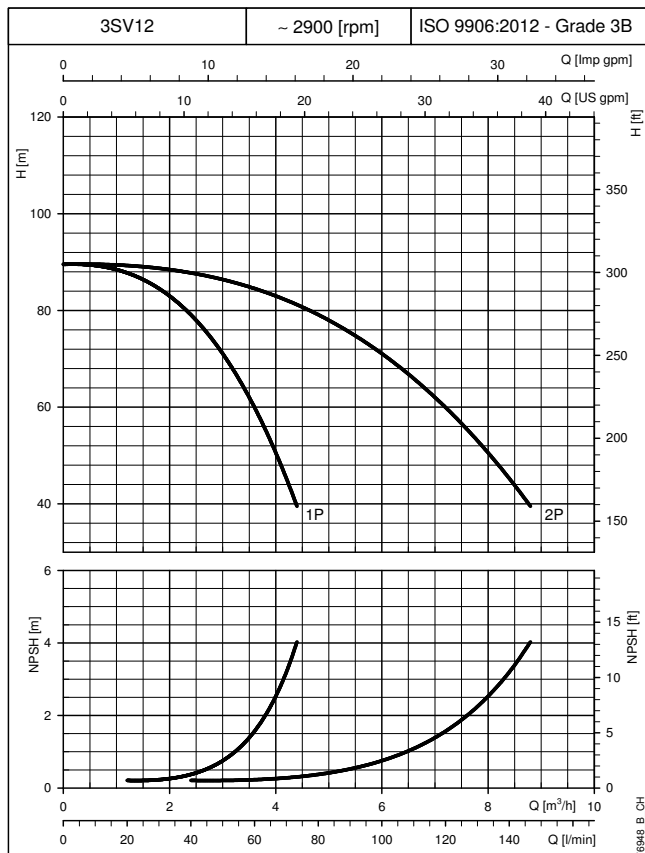
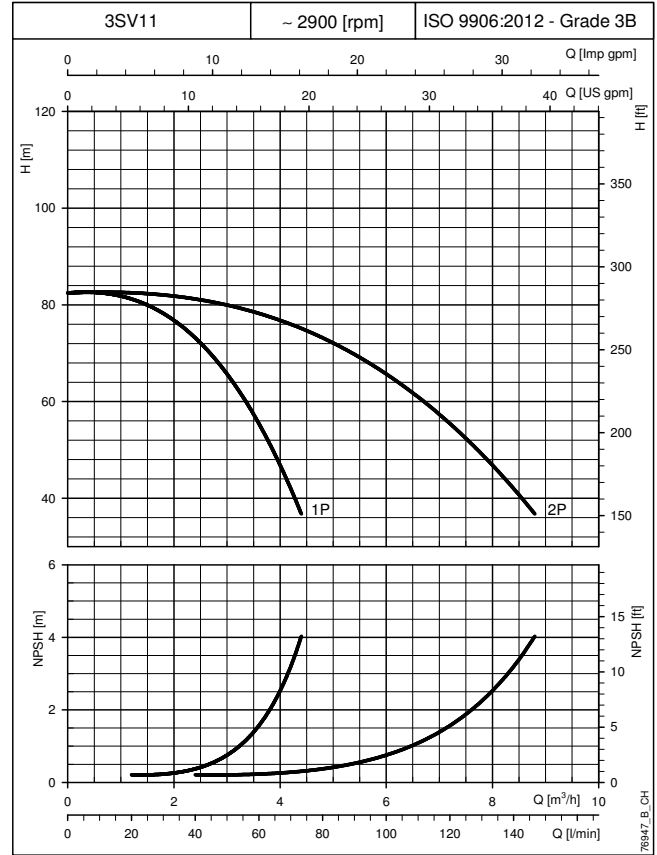
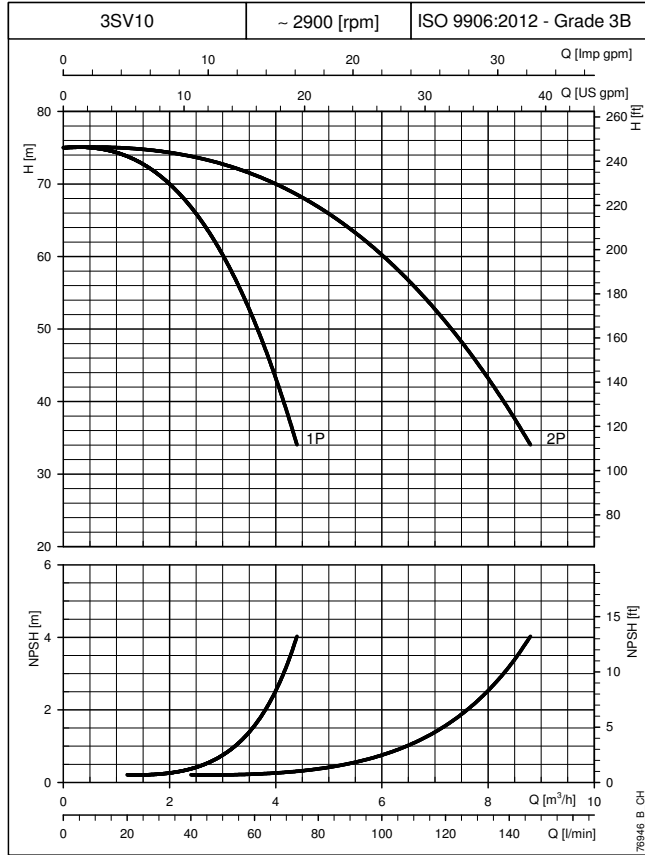

The performance curves do not take into account flow resistance in the valves and piping.
 The curves show the performance with one and two pumps running.
 These performances are valid for liquids with density $\rho = 1.0 \text{ kg/dm}^3$ and kinematic viscosity $\nu = 1 \text{ mm}^2/\text{sec}$.
 The declared NPSH values are laboratory values: for practical use we recommend increasing these values by 0,5 m.

BOOSTER SETS GX5 AND GMD SERIES OPERATING CHARACTERISTICS AT 50 Hz

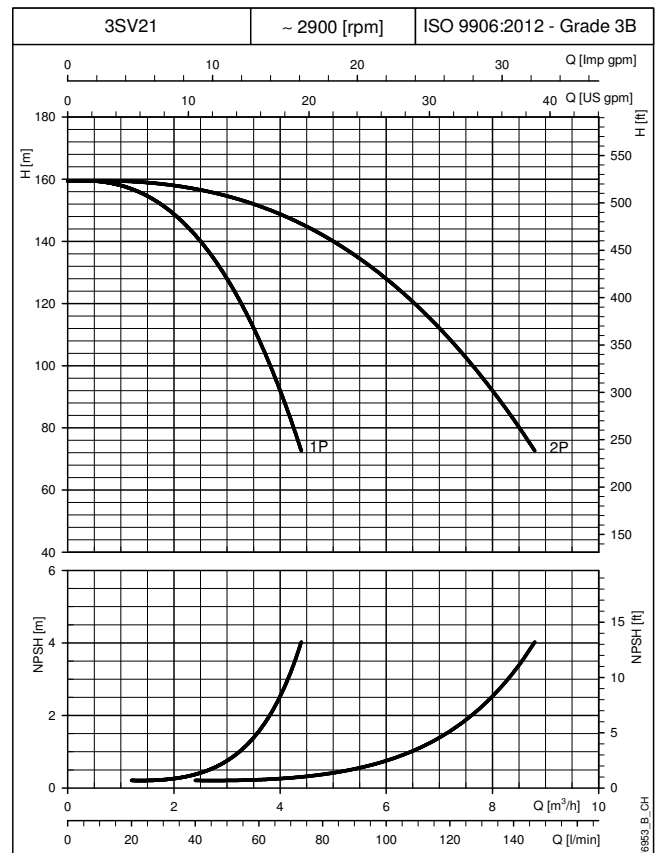
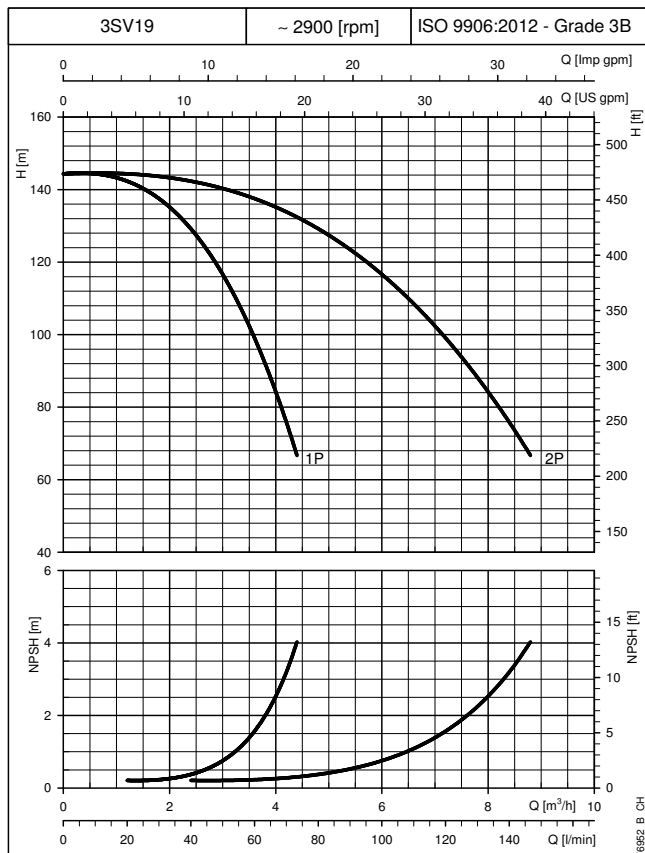
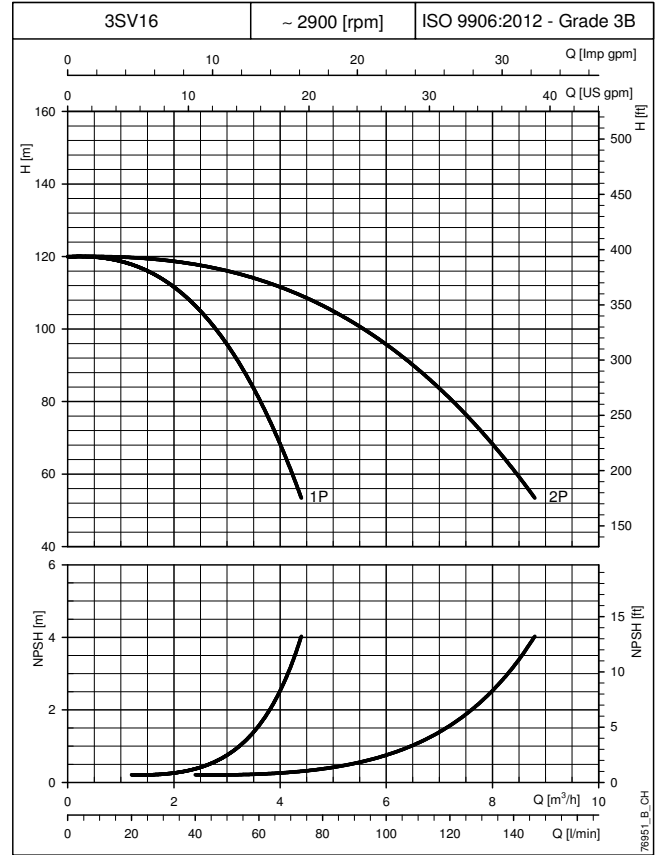
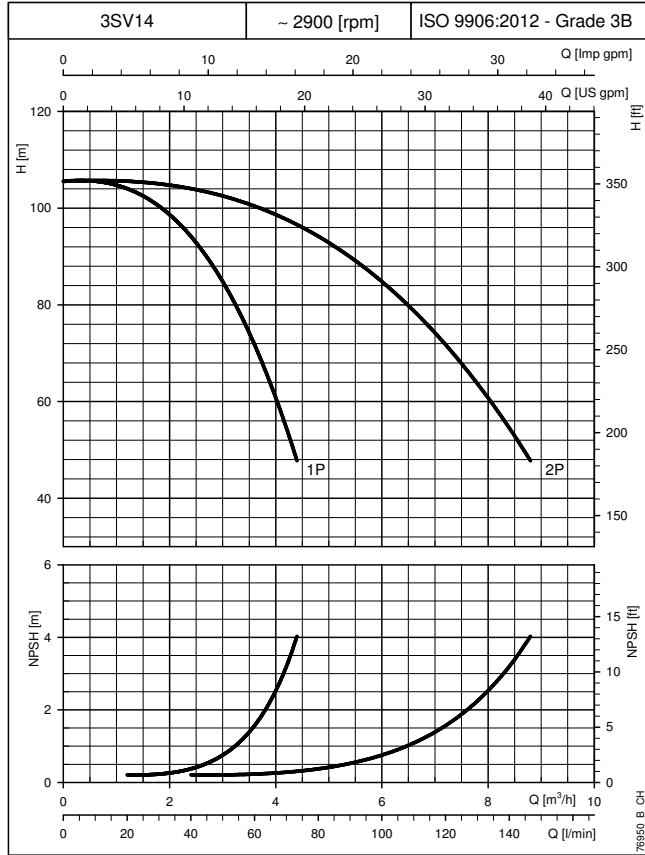

The performance curves do not take into account flow resistance in the valves and piping.
 The curves show the performance with one and two pumps running.
 These performances are valid for liquids with density $\rho = 1.0 \text{ kg/dm}^3$ and kinematic viscosity $\nu = 1 \text{ mm}^2/\text{sec}$.
 The declared NPSH values are laboratory values: for practical use we recommend increasing these values by 0,5 m.

BOOSTER SETS GX5 AND GMD SERIES OPERATING CHARACTERISTICS AT 50 Hz

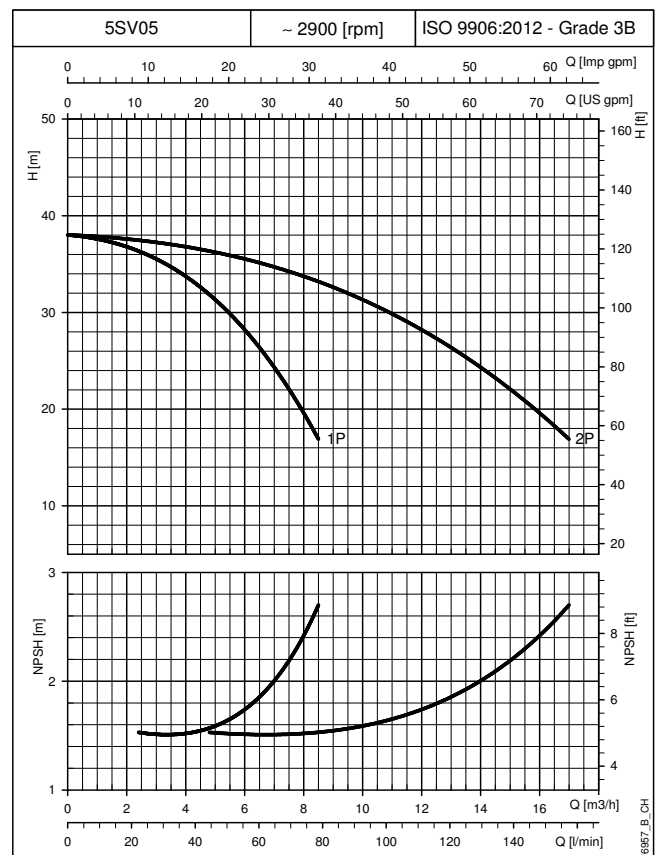
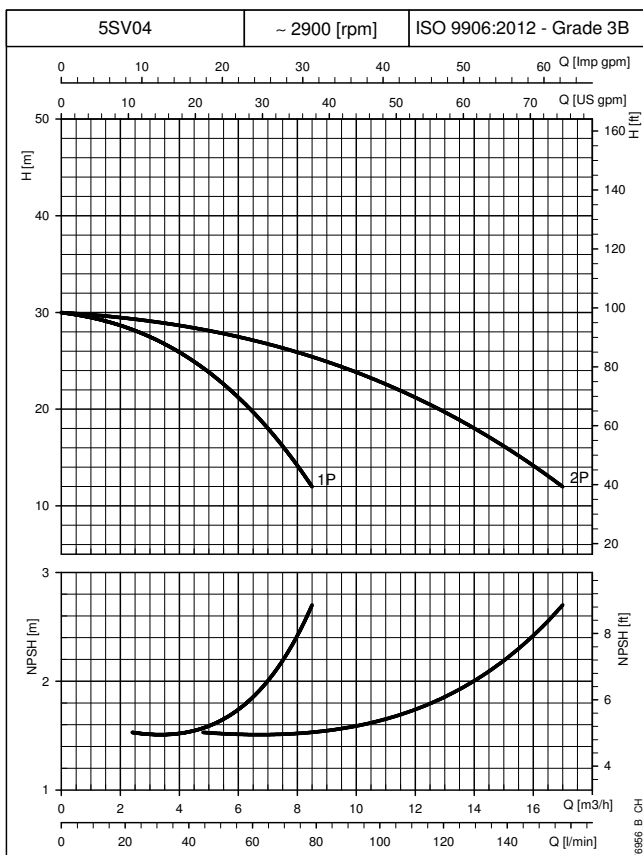
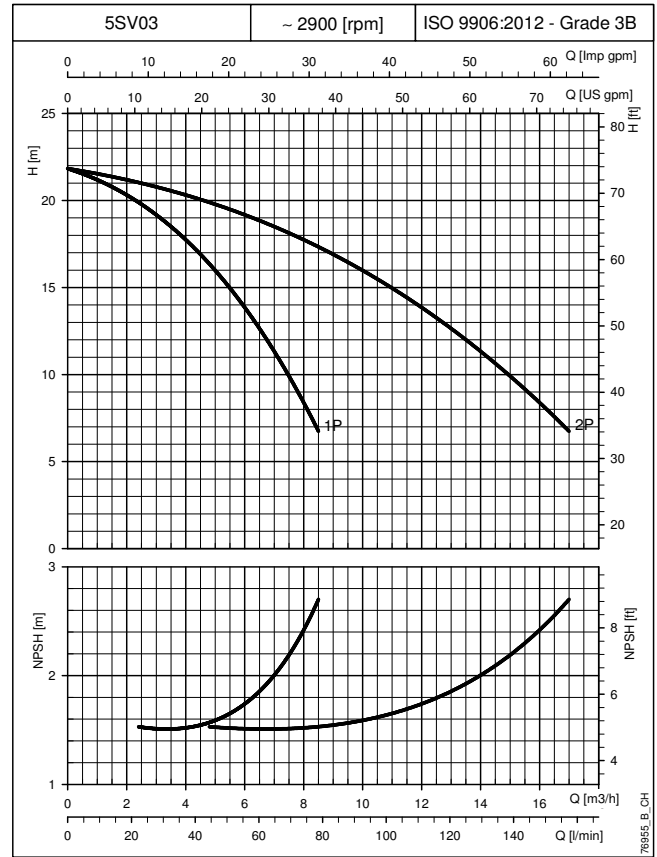
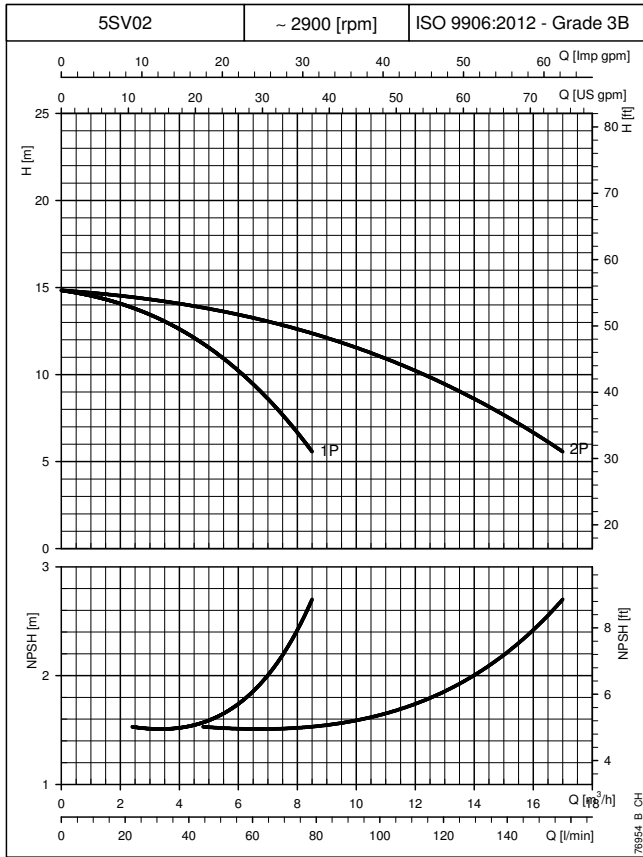

The performance curves do not take into account flow resistance in the valves and piping.
The curves show the performance with one and two pumps running.

These performances are valid for liquids with density $\rho = 1.0 \text{ kg/dm}^3$ and kinematic viscosity $\nu = 1 \text{ mm}^2/\text{sec}$.

The declared NPSH values are laboratory values: for practical use we recommend increasing these values by 0,5 m.

BOOSTER SETS GX5 AND GMD SERIES OPERATING CHARACTERISTICS AT 50 Hz

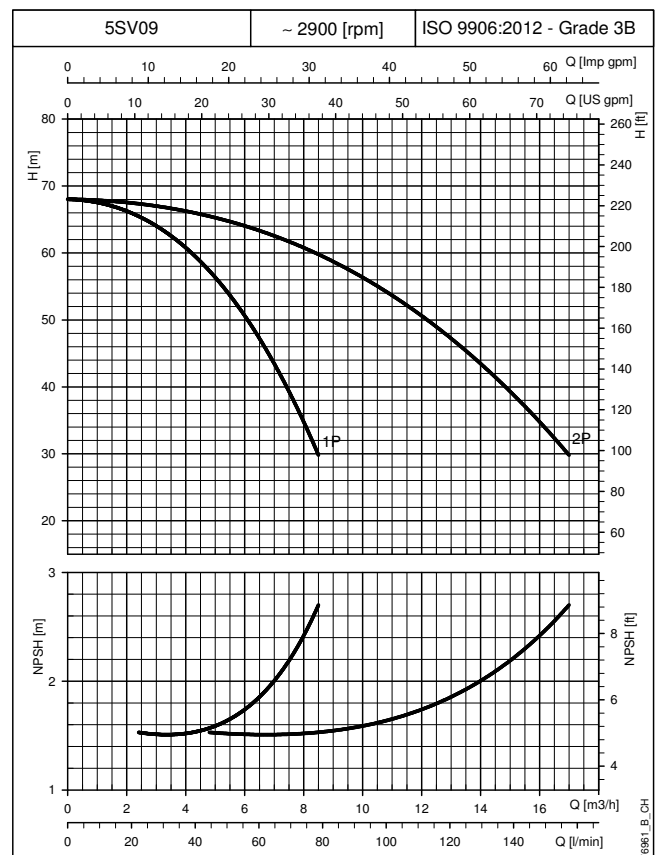
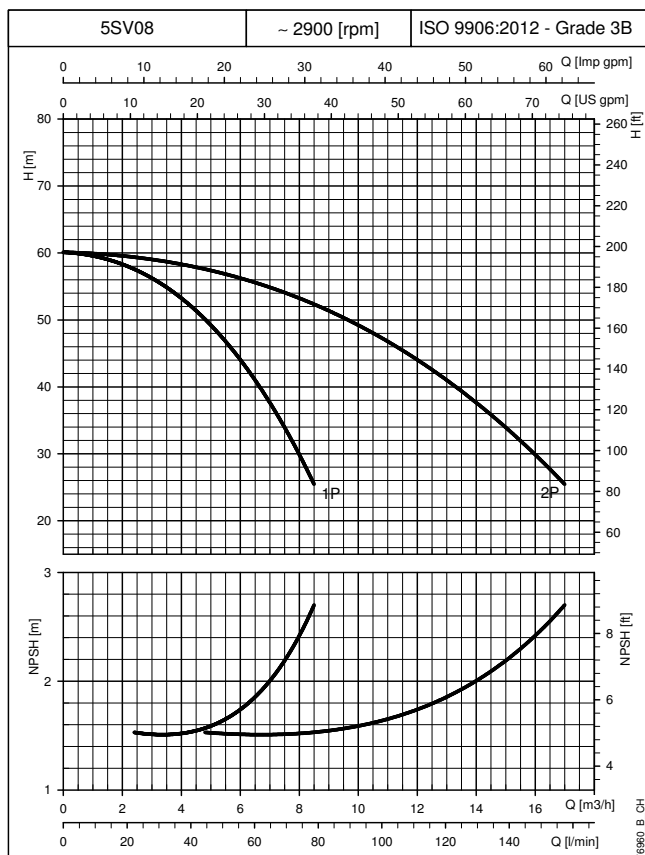
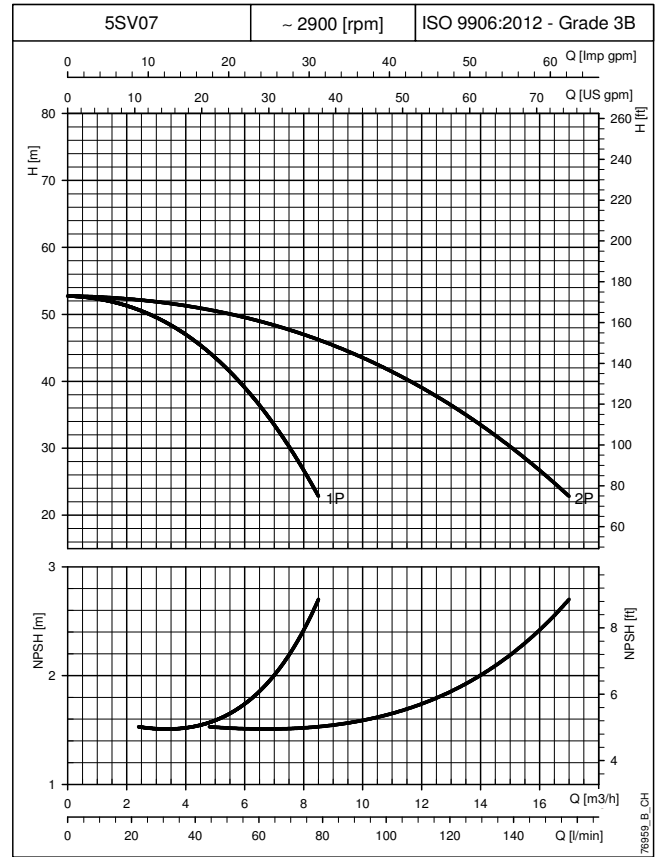
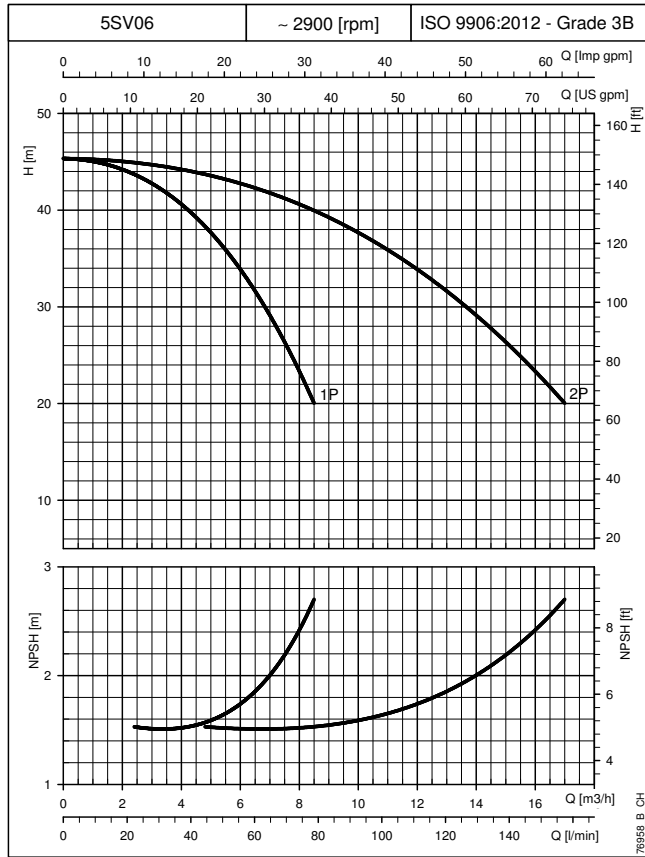

The performance curves do not take into account flow resistance in the valves and piping.
 The curves show the performance with one and two pumps running.
 These performances are valid for liquids with density $\rho = 1.0 \text{ kg/dm}^3$ and kinematic viscosity $\nu = 1 \text{ mm}^2/\text{sec}$.
 The declared NPSH values are laboratory values: for practical use we recommend increasing these values by 0,5 m.

BOOSTER SETS GX5 AND GMD SERIES OPERATING CHARACTERISTICS AT 50 Hz

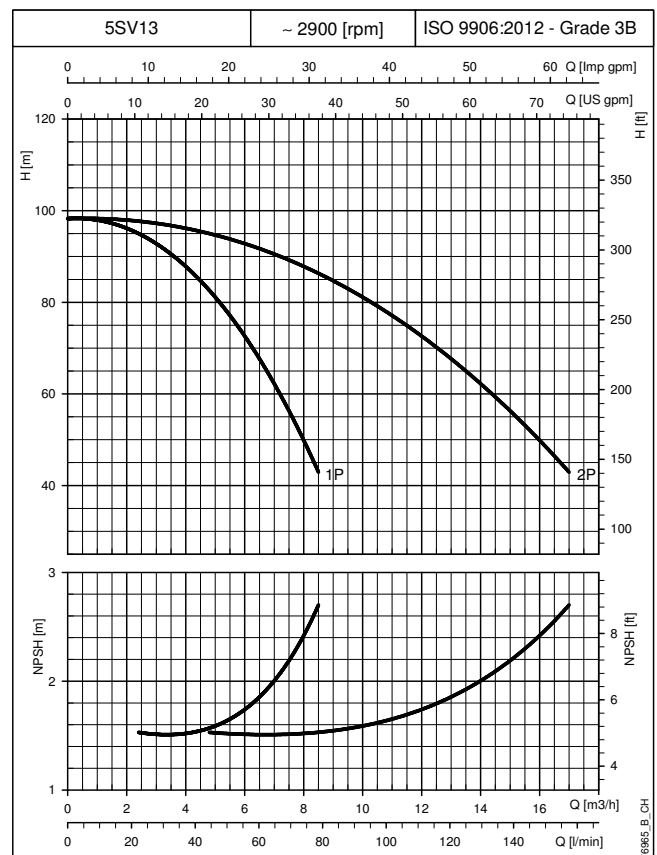
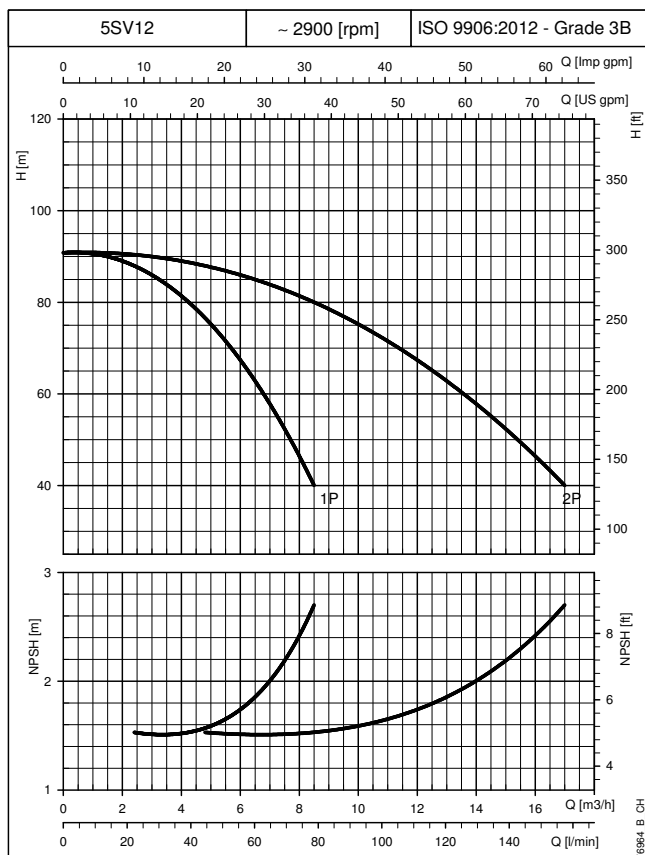
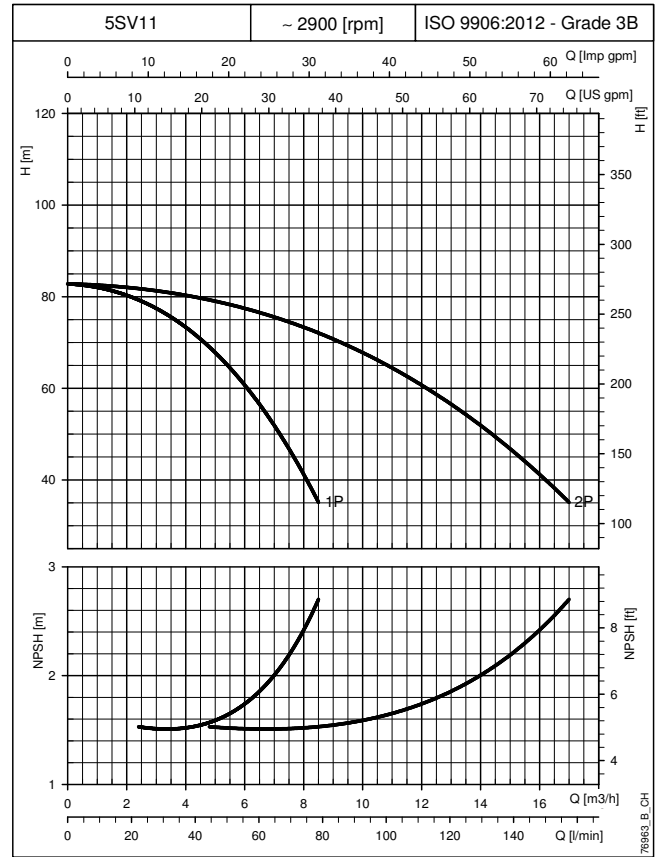
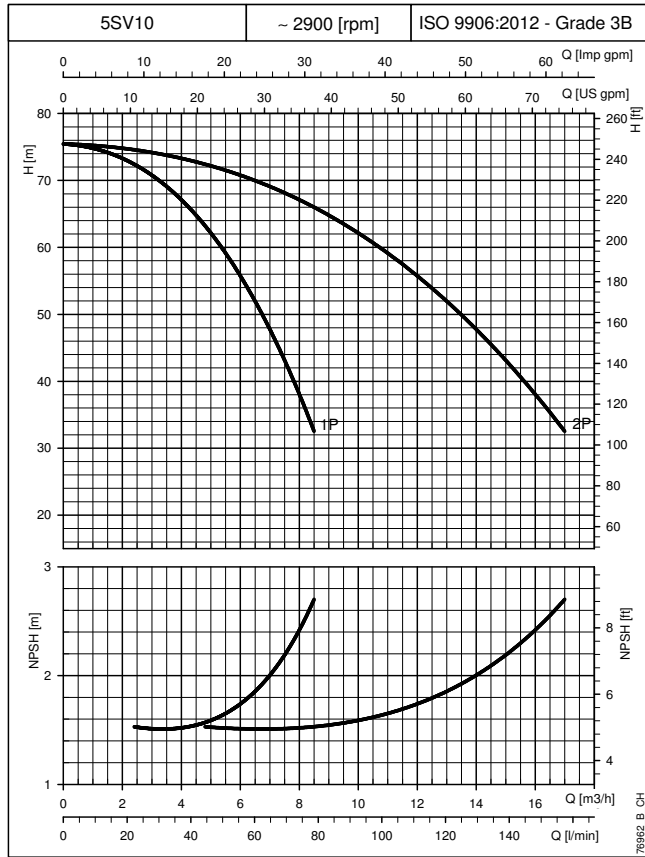

The performance curves do not take into account flow resistance in the valves and piping.
 The curves show the performance with one and two pumps running.
 These performances are valid for liquids with density $\rho = 1.0 \text{ kg/dm}^3$ and kinematic viscosity $\nu = 1 \text{ mm}^2/\text{sec}$.
 The declared NPSH values are laboratory values: for practical use we recommend increasing these values by 0,5 m.

BOOSTER SETS GX5 AND GMD SERIES OPERATING CHARACTERISTICS AT 50 Hz

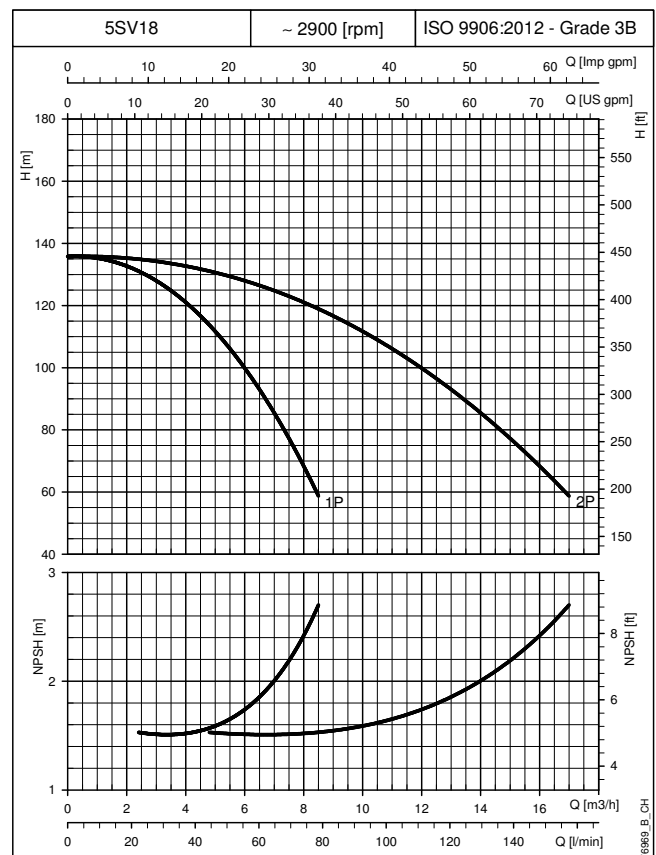
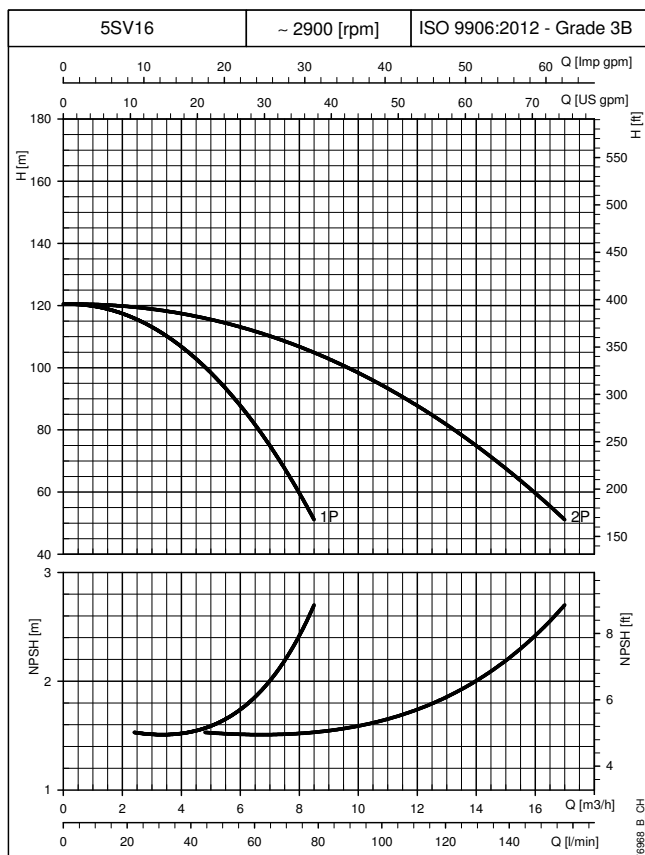
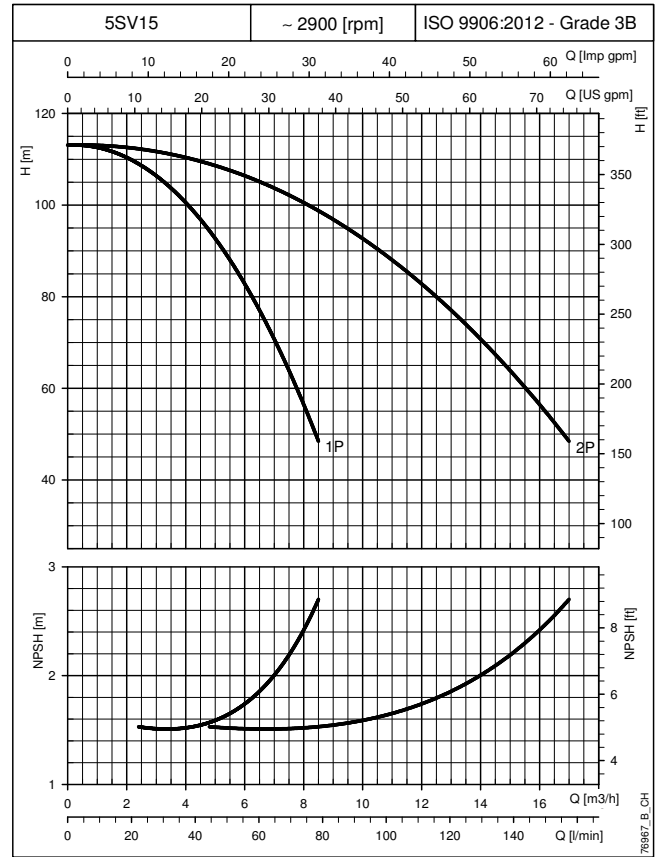
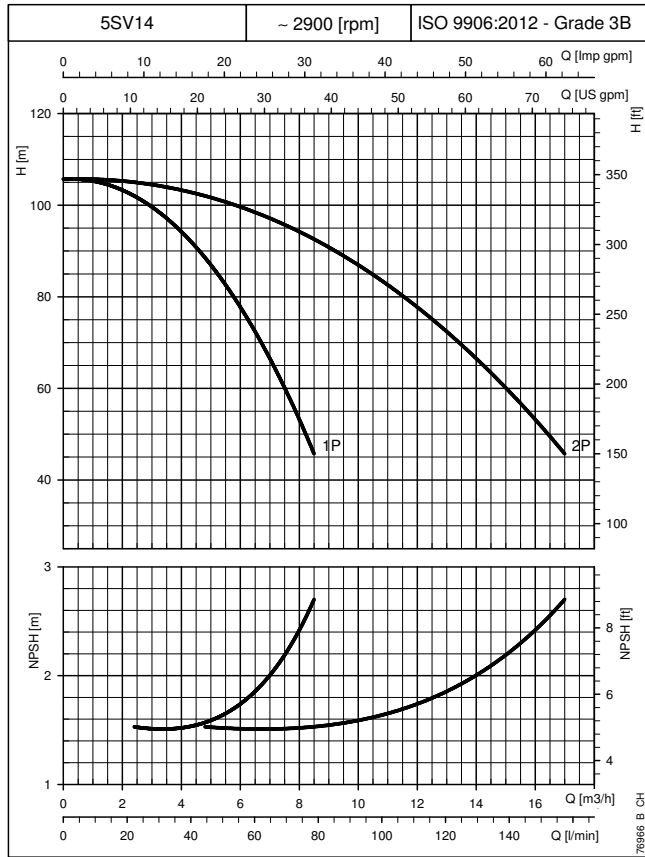

The performance curves do not take into account flow resistance in the valves and piping.
 The curves show the performance with one and two pumps running.
 These performances are valid for liquids with density $\rho = 1.0 \text{ kg/dm}^3$ and kinematic viscosity $\nu = 1 \text{ mm}^2/\text{sec}$.
 The declared NPSH values are laboratory values: for practical use we recommend increasing these values by 0,5 m.

BOOSTER SETS GX5 AND GMD SERIES OPERATING CHARACTERISTICS AT 50 Hz

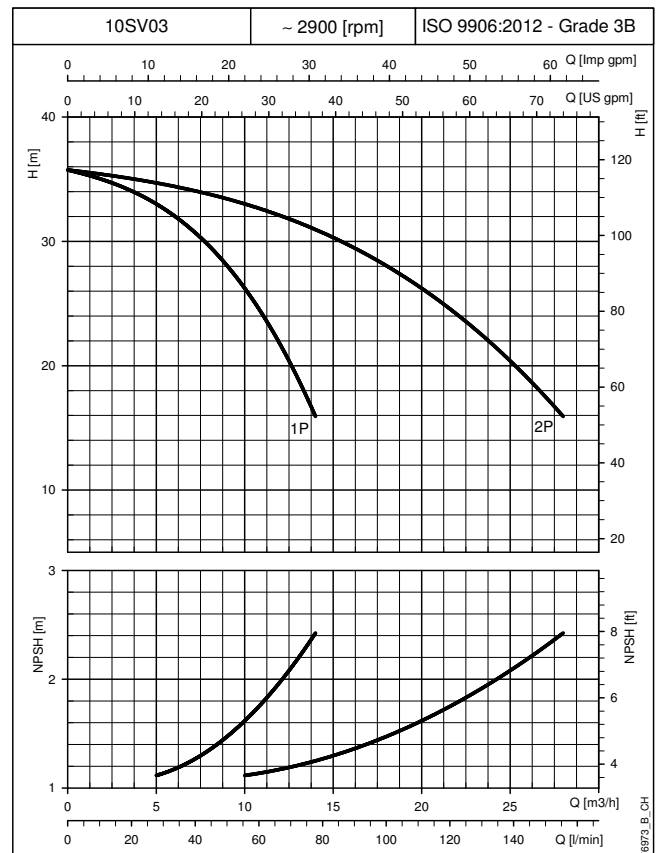
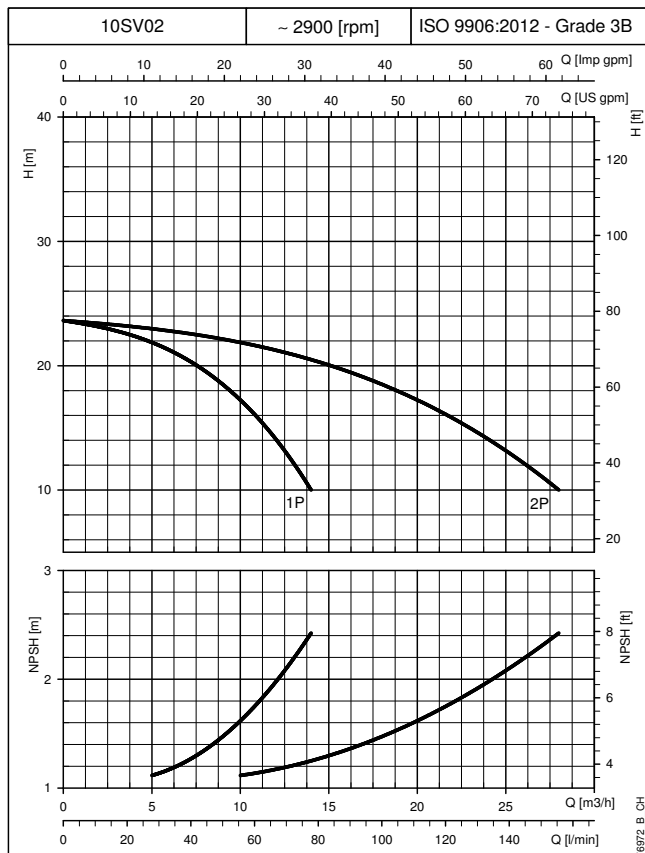
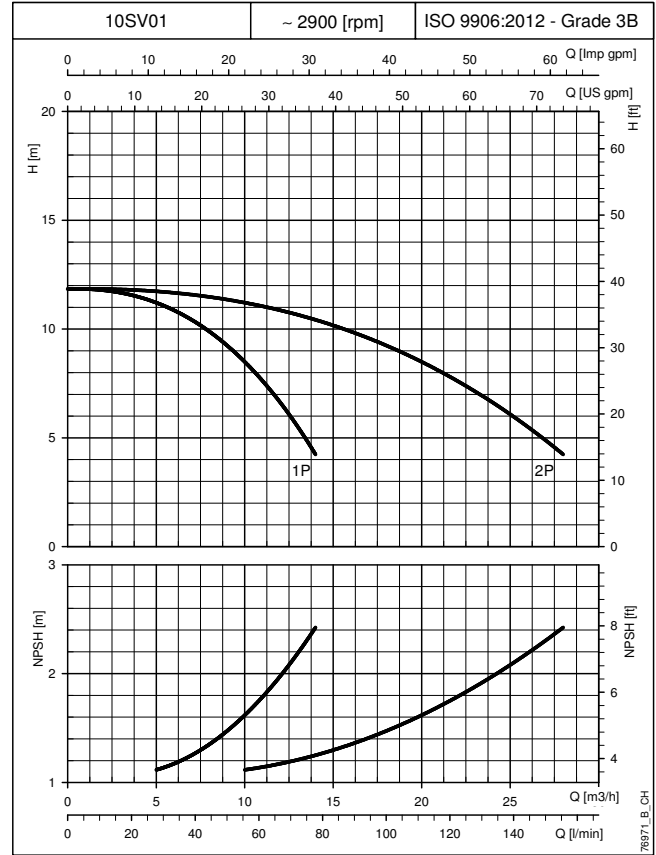
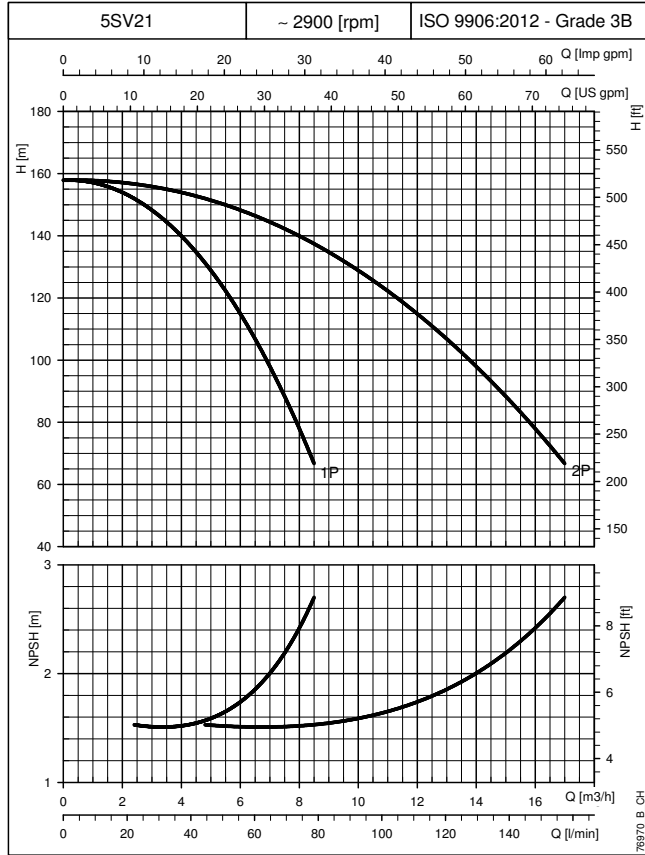

The performance curves do not take into account flow resistance in the valves and piping.
 The curves show the performance with one and two pumps running.
 These performances are valid for liquids with density $\rho = 1.0 \text{ kg/dm}^3$ and kinematic viscosity $\nu = 1 \text{ mm}^2/\text{sec}$.
 The declared NPSH values are laboratory values: for practical use we recommend increasing these values by 0,5 m.

BOOSTER SETS GX5 AND GMD SERIES OPERATING CHARACTERISTICS AT 50 Hz

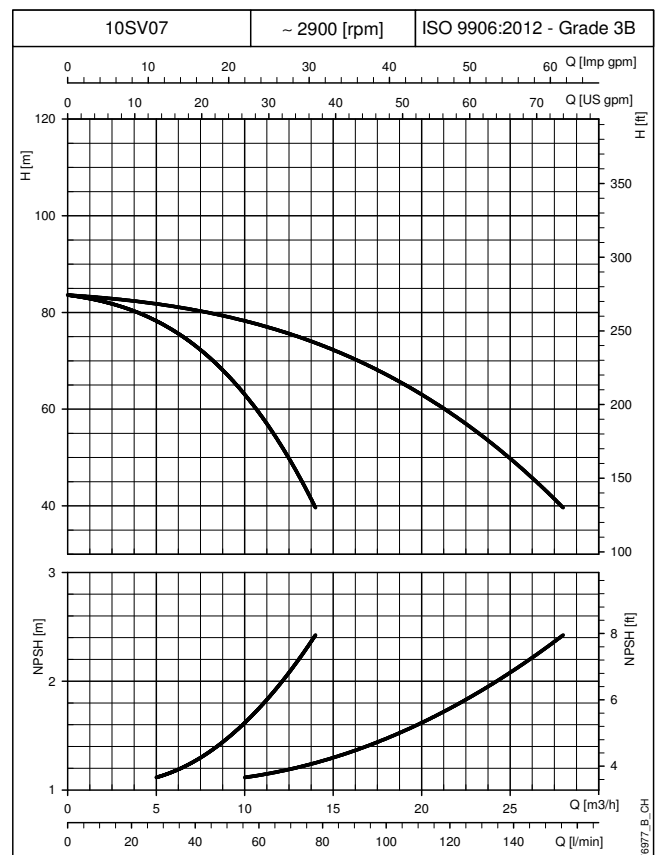
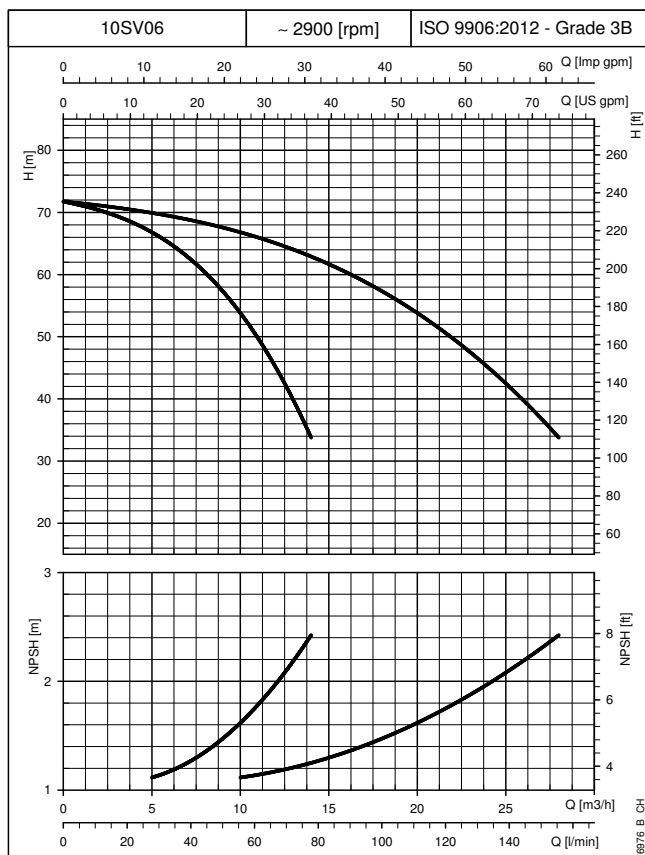
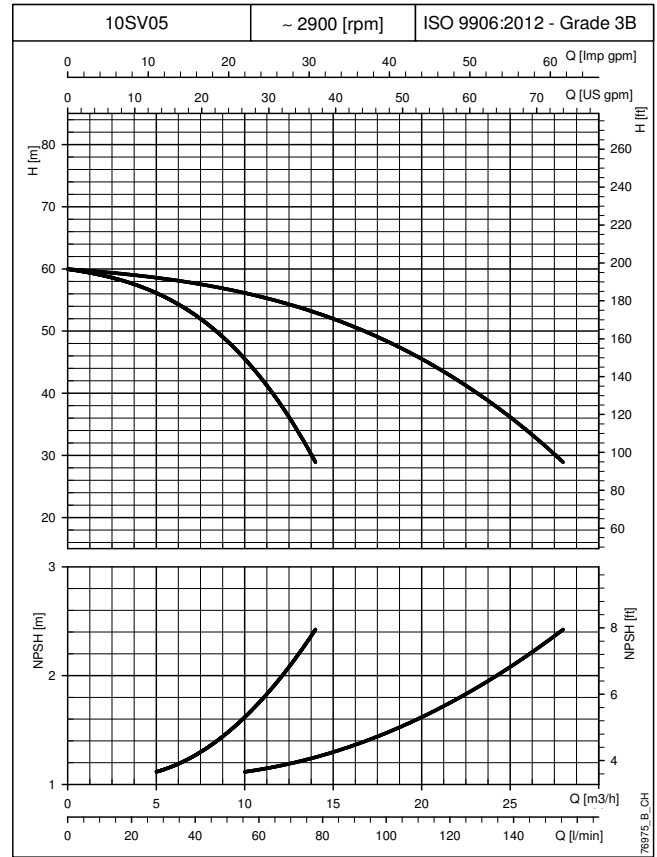
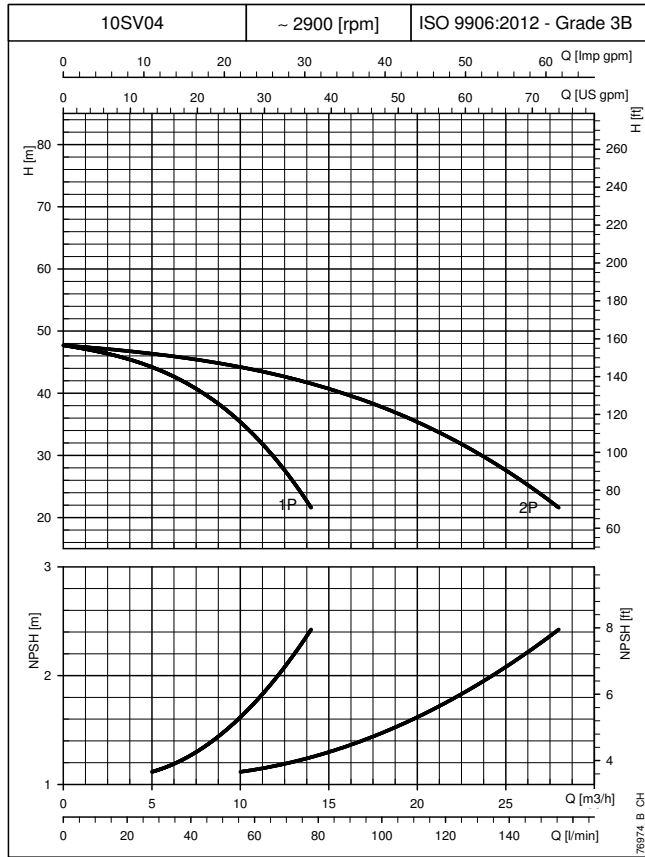

The performance curves do not take into account flow resistance in the valves and piping.
 The curves show the performance with one and two pumps running.
 These performances are valid for liquids with density $\rho = 1.0 \text{ kg/dm}^3$ and kinematic viscosity $\nu = 1 \text{ mm}^2/\text{sec}$.
 The declared NPSH values are laboratory values; for practical use we recommend increasing these values by 0,5 m.

BOOSTER SETS GX5 AND GMD SERIES OPERATING CHARACTERISTICS AT 50 Hz

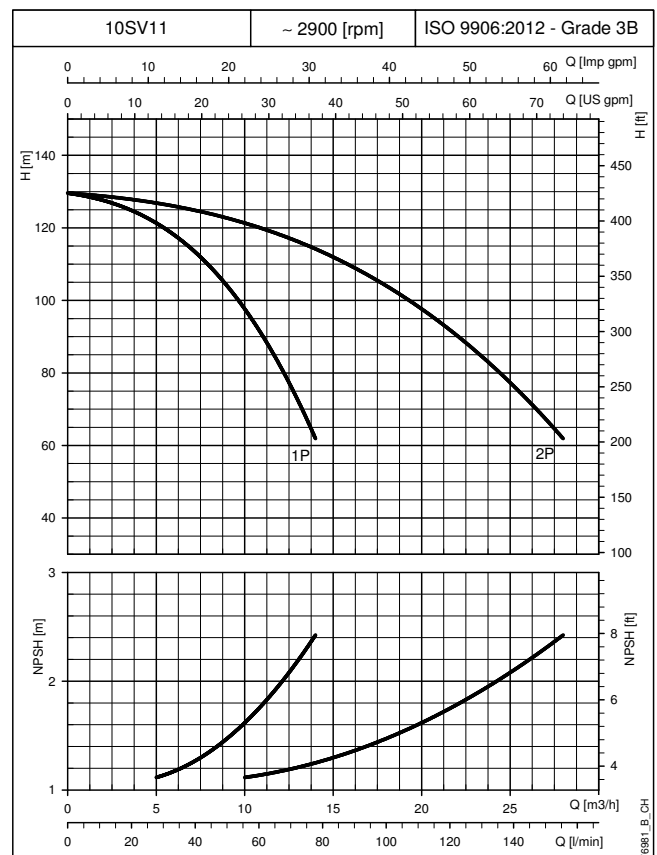
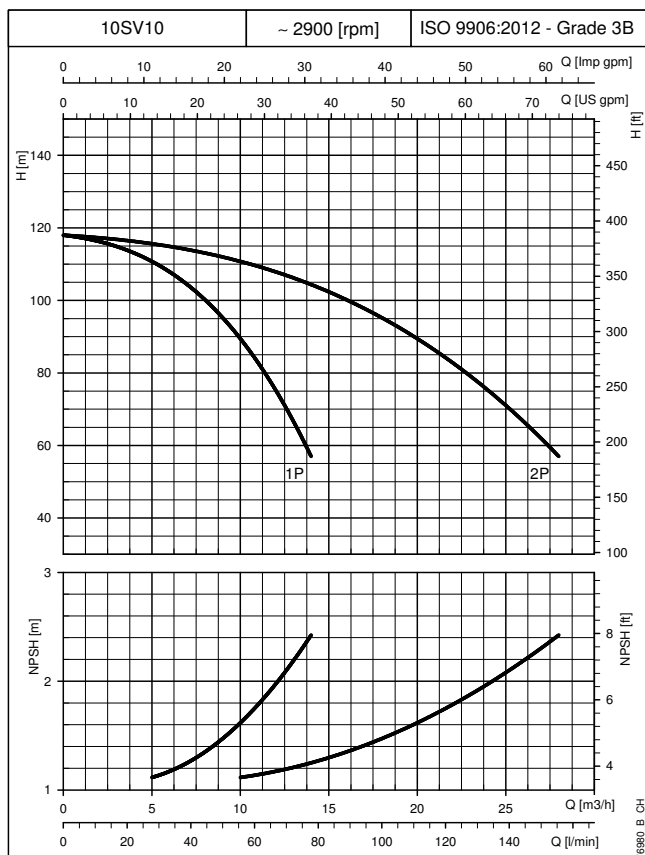
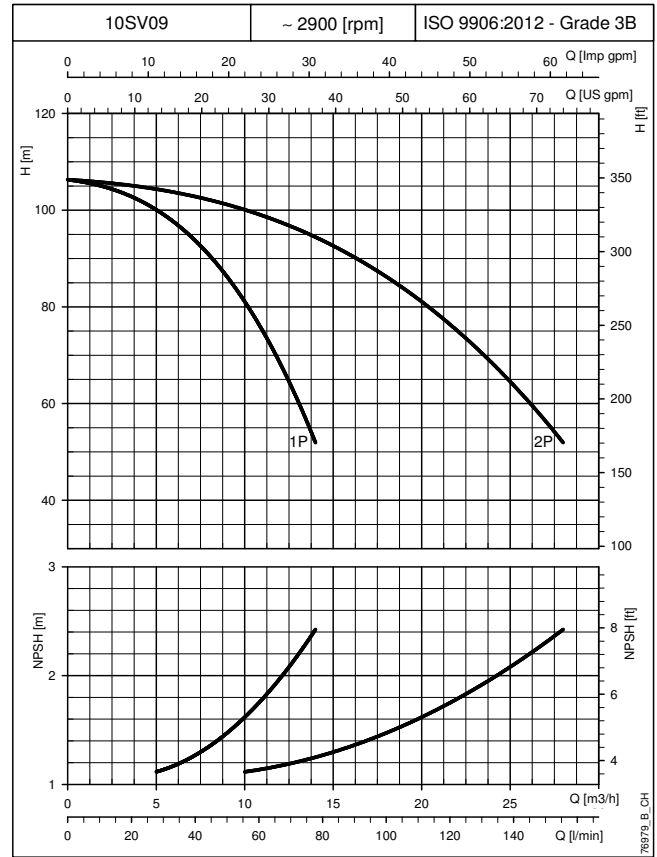
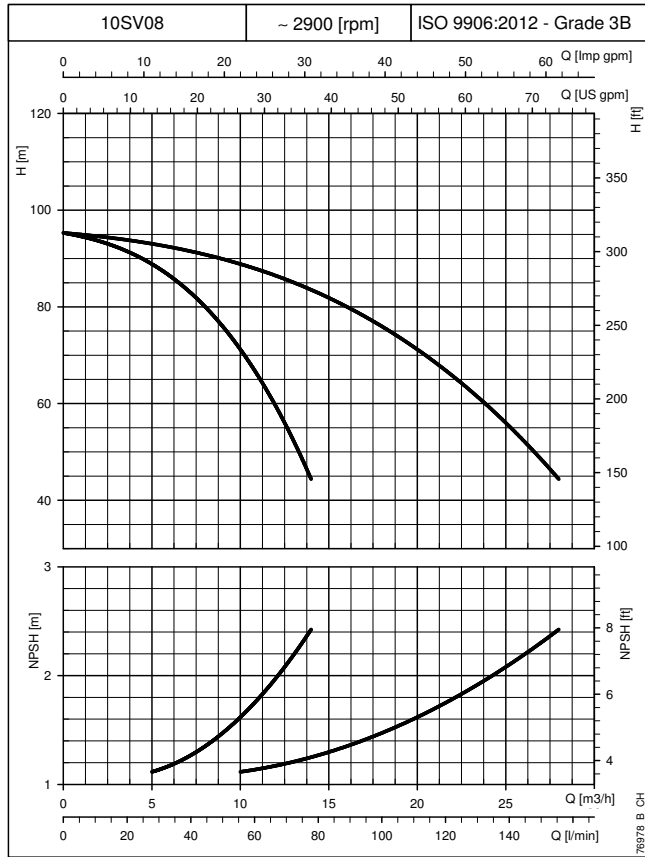

The performance curves do not take into account flow resistance in the valves and piping.
 The curves show the performance with one and two pumps running.
 These performances are valid for liquids with density $\rho = 1.0 \text{ kg/dm}^3$ and kinematic viscosity $\nu = 1 \text{ mm}^2/\text{sec}$.
 The declared NPSH values are laboratory values: for practical use we recommend increasing these values by 0,5 m.

BOOSTER SETS GX5 AND GMD SERIES H_c PRESSURE DROP CURVE

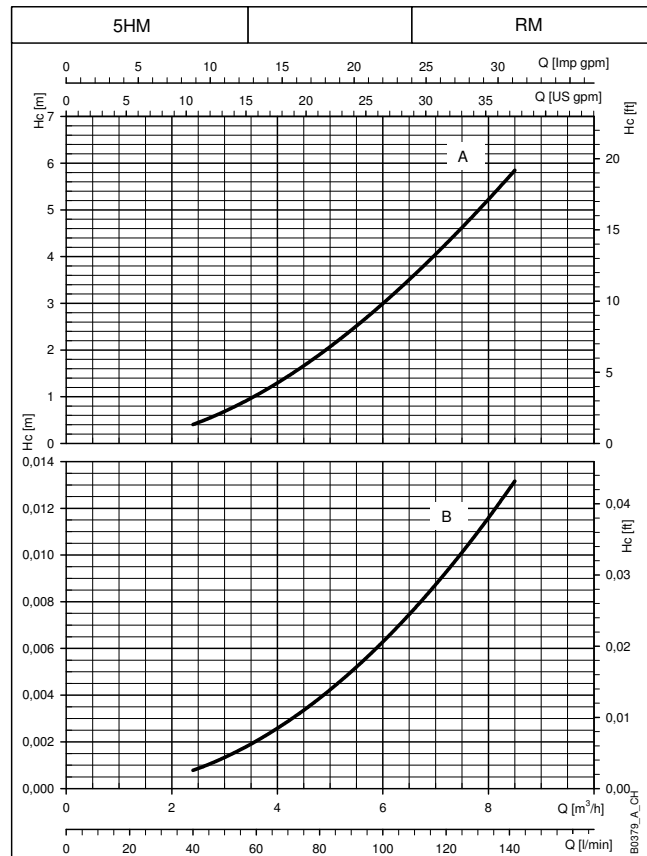
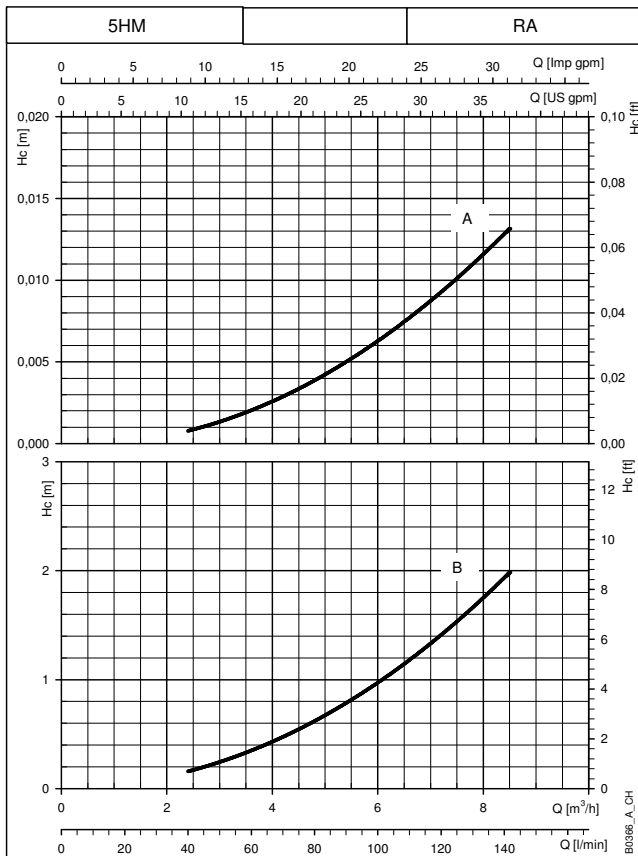
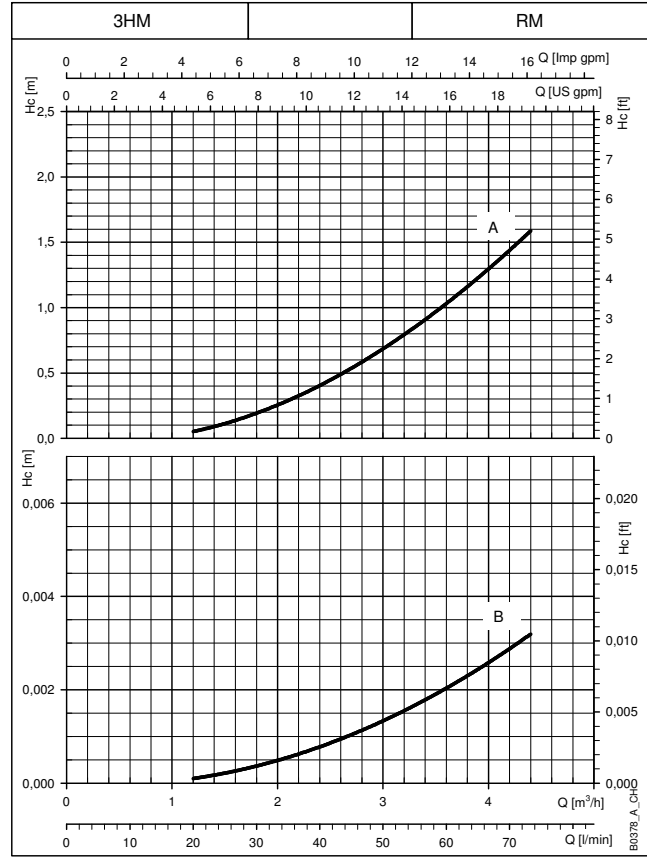
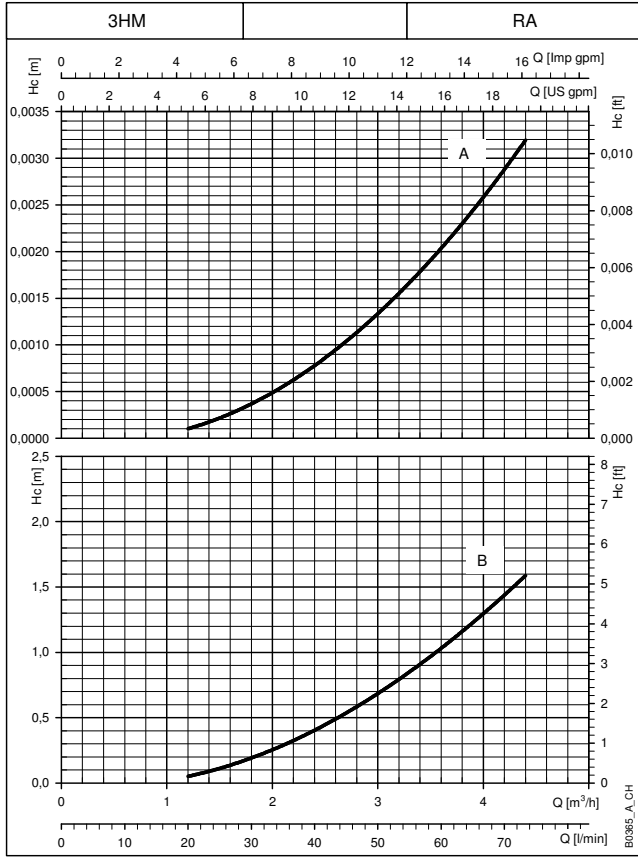

The declared curves are valid for liquids with density $\rho = 1 \text{ kg/dm}^3$ and kinematic viscosity $\nu = 1 \text{ mm}^2/\text{sec}$.
H_c (A): Pressure drop curve on delivery side of the pump. H_c (B): Pressure drop curve on suction side of the pump.
RA: check valve on suction side. RM: check valve on delivery side.
The pressure drops do not consider the distributed pressure drops on the manifold.

**BOOSTER SETS GX5 AND GMD SERIES
H_c PRESSURE DROP CURVE**

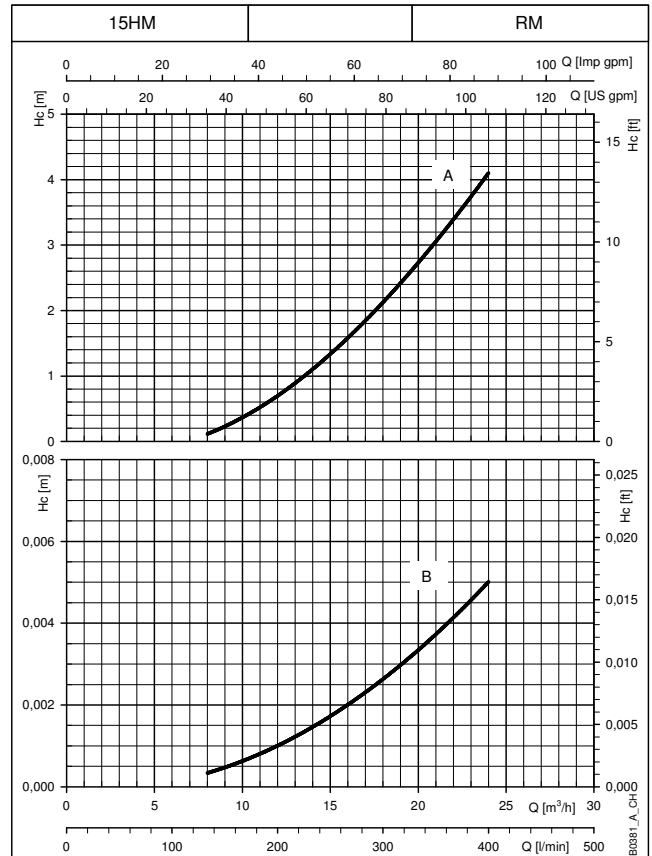
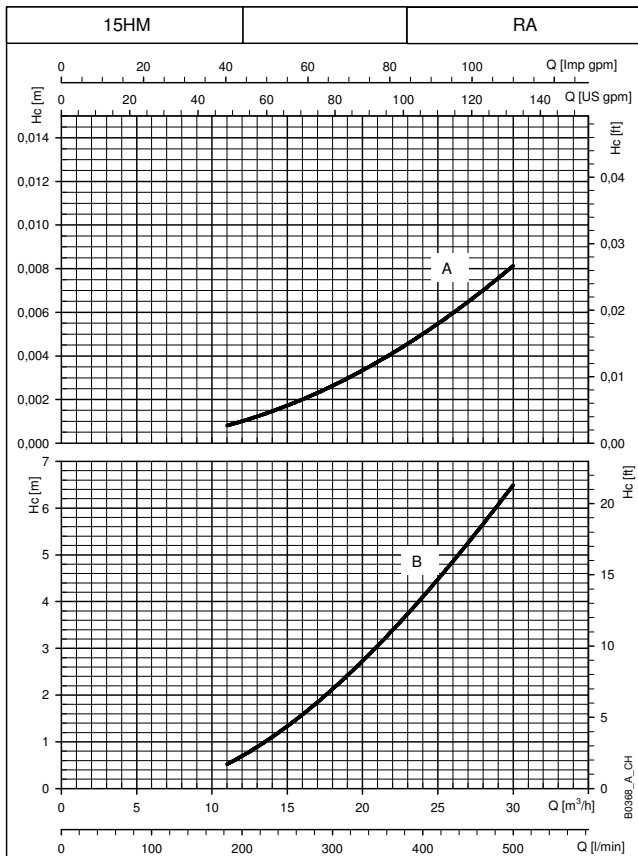
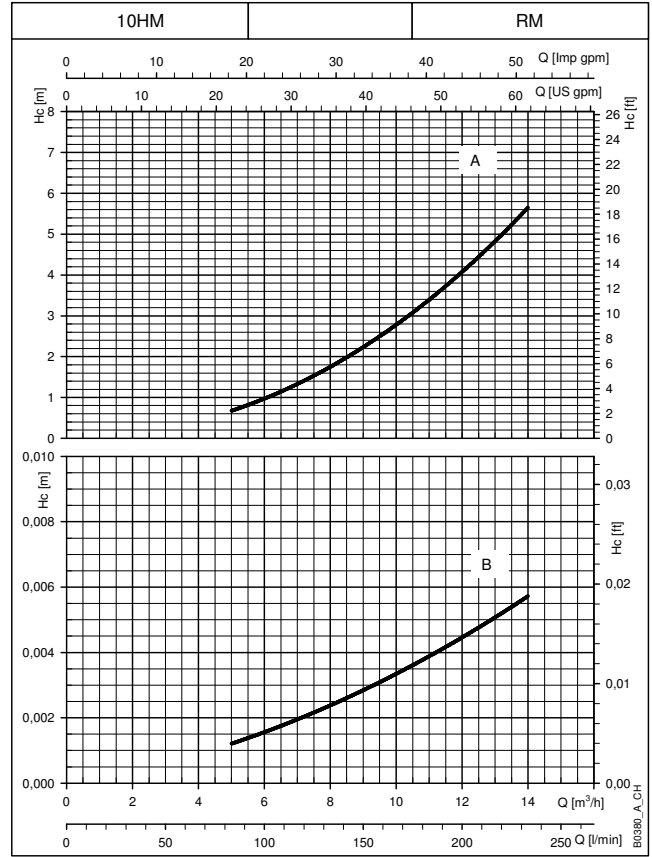
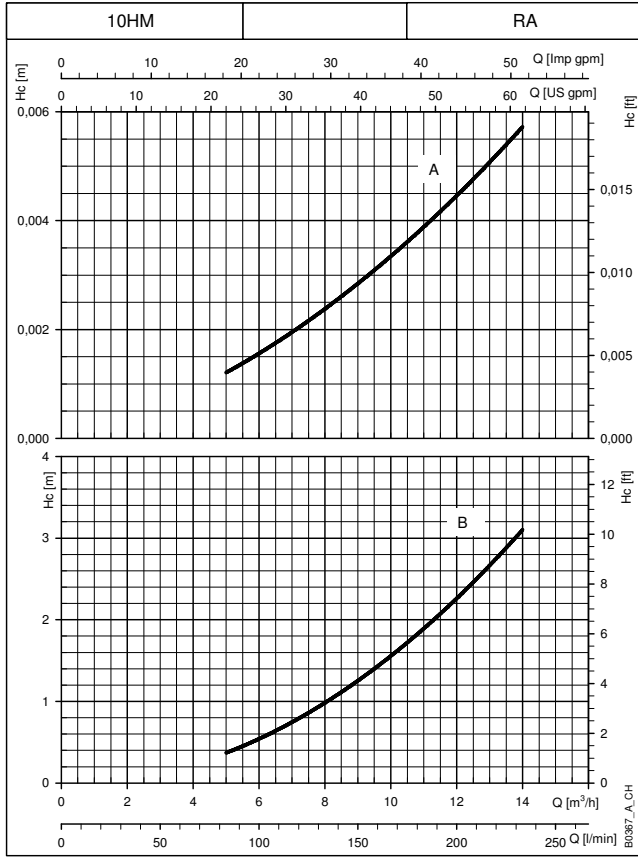

The declared curves are valid for liquids with density $\rho = 1 \text{ kg/dm}^3$ and kinematic viscosity $\nu = 1 \text{ mm}^2/\text{sec}$.
H_c (A): Pressure drop curve on delivery side of the pump. H_c (B): Pressure drop curve on suction side of the pump.
RA: check valve on suction side. RM: check valve on delivery side.
The pressure drops do not consider the distributed pressure drops on the manifold.

BOOSTER SETS GX5 AND GMD SERIES H_c PRESSURE DROP CURVE

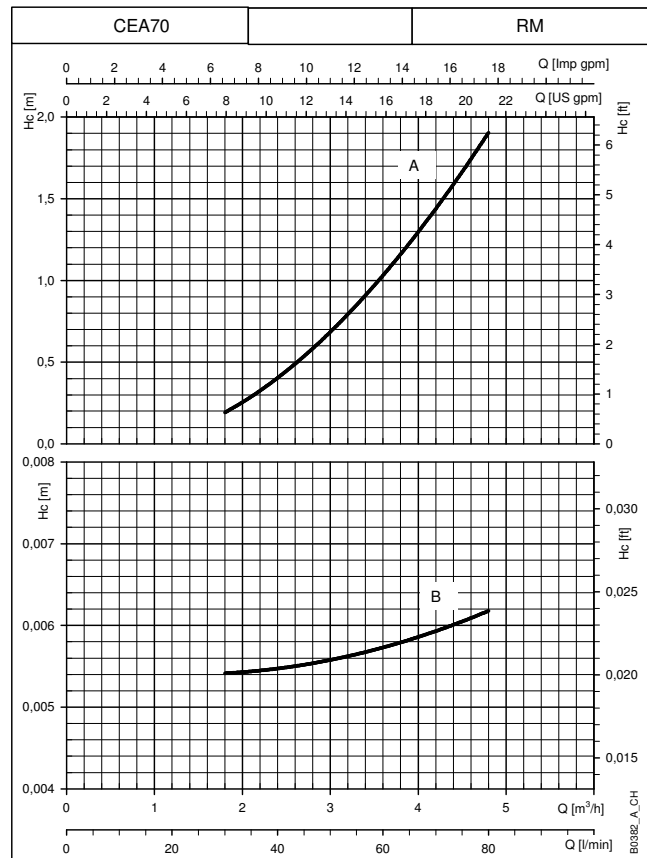
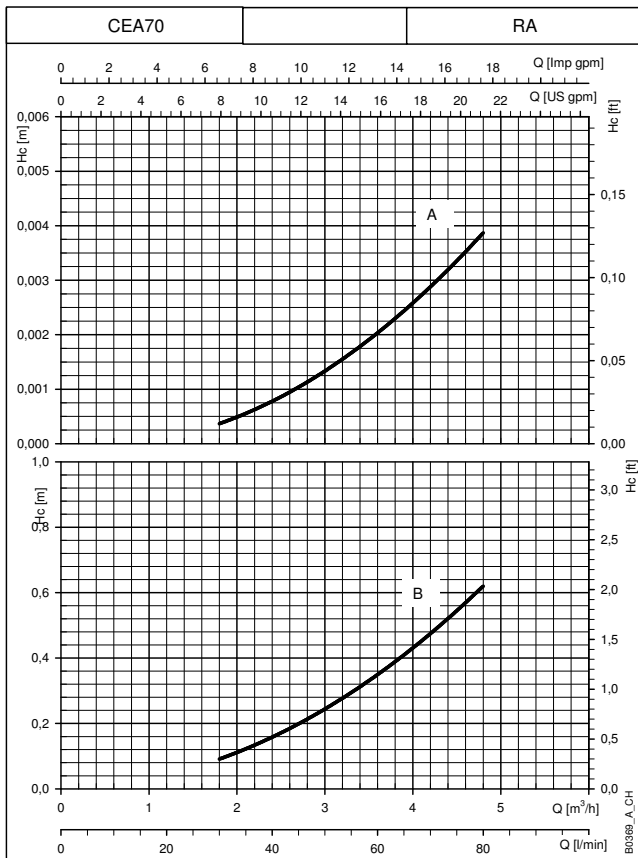
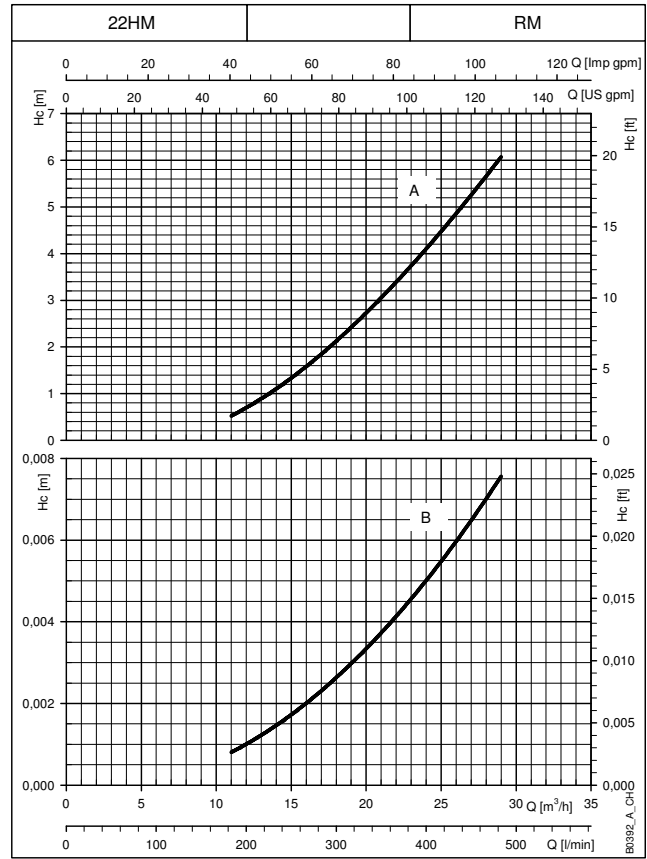
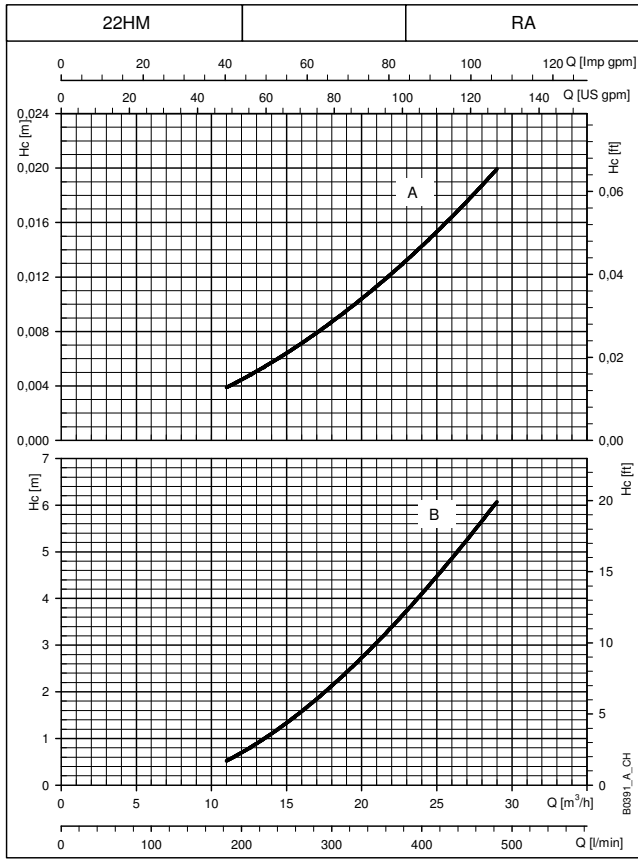

The declared curves are valid for liquids with density $\rho = 1 \text{ kg/dm}^3$ and kinematic viscosity $\nu = 1 \text{ mm}^2/\text{sec}$.
H_c (A): Pressure drop curve on delivery side of the pump. H_c (B): Pressure drop curve on suction side of the pump.
RA: check valve on suction side. RM: check valve on delivery side.
The pressure drops do not consider the distributed pressure drops on the manifold.

BOOSTER SETS GX5 AND GMD SERIES
H_c PRESSURE DROP CURVE

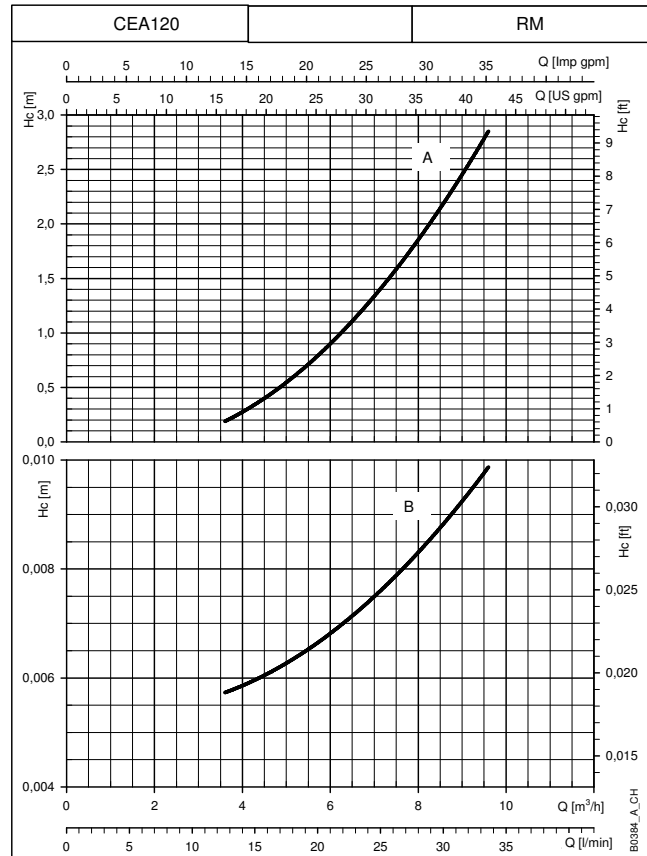
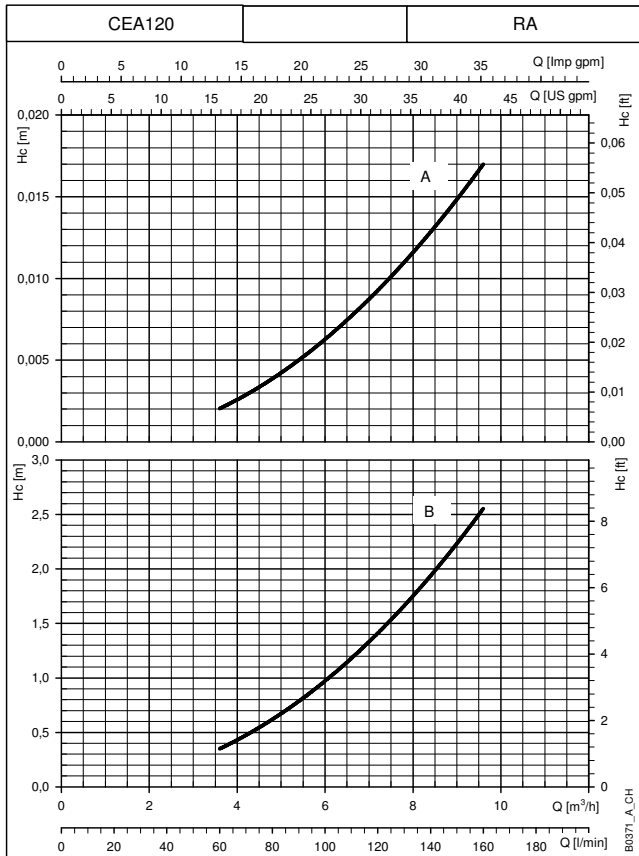
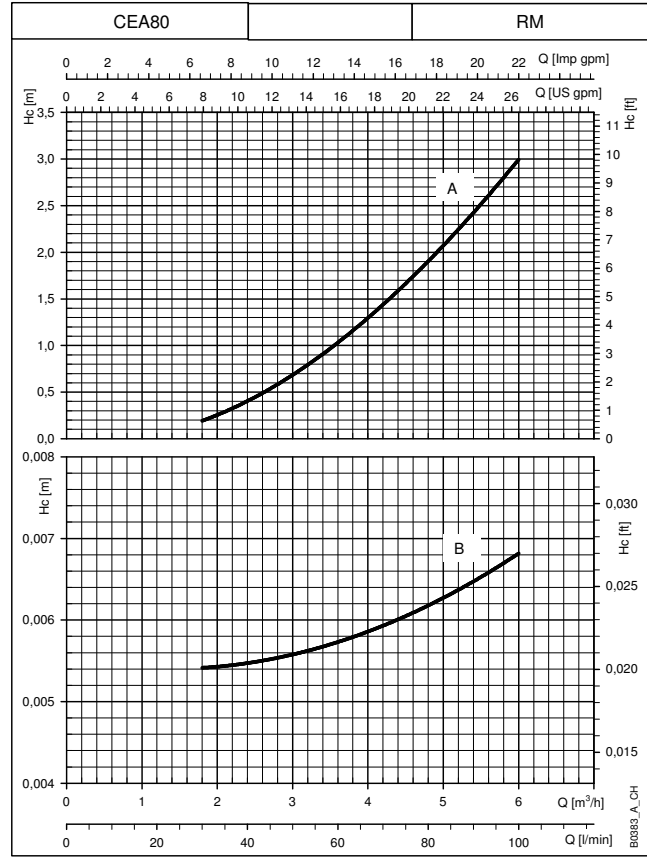
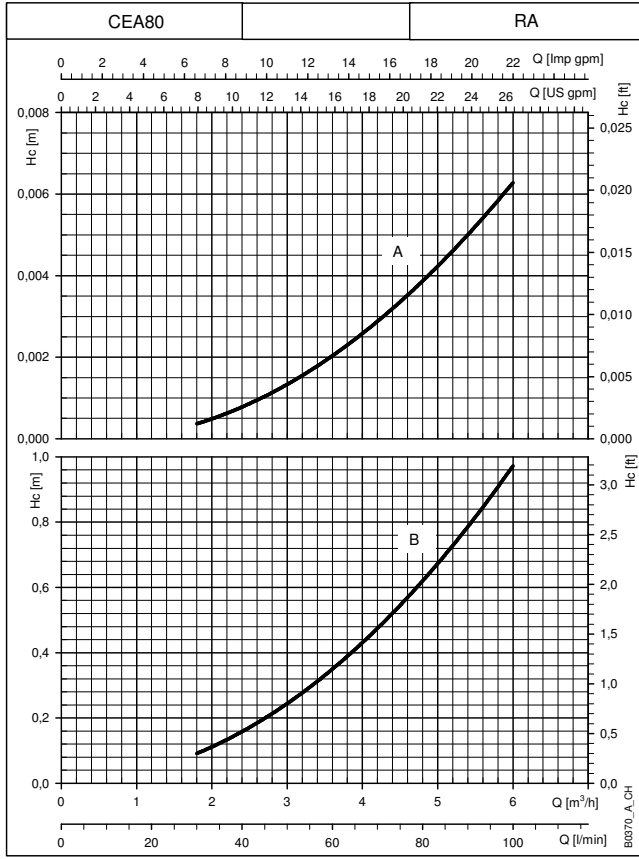

The declared curves are valid for liquids with density $\rho = 1 \text{ kg/dm}^3$ and kinematic viscosity $\nu = 1 \text{ mm}^2/\text{sec}$.
Hc (A): Pressure drop curve on delivery side of the pump. Hc (B): Pressure drop curve on suction side of the pump.
RA: check valve on suction side. RM: check valve on delivery side.
The pressure drops do not consider the distributed pressure drops on the manifold.

BOOSTER SETS GX5 AND GMD SERIES H_c PRESSURE DROP CURVE

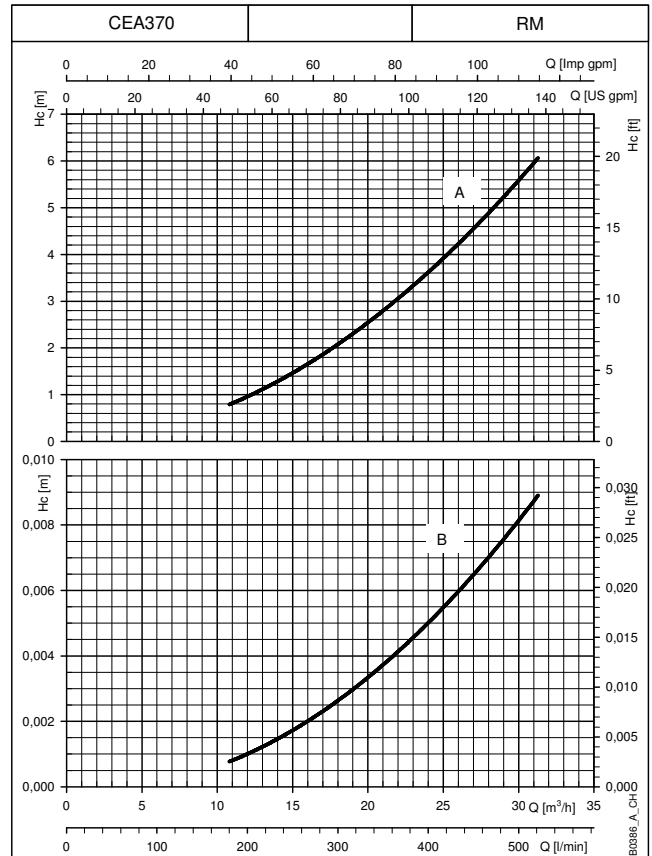
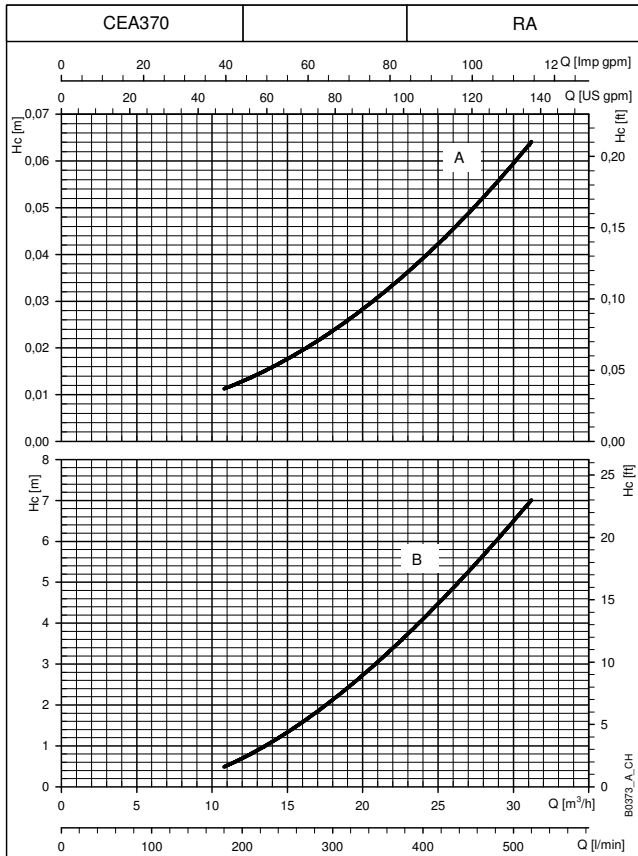
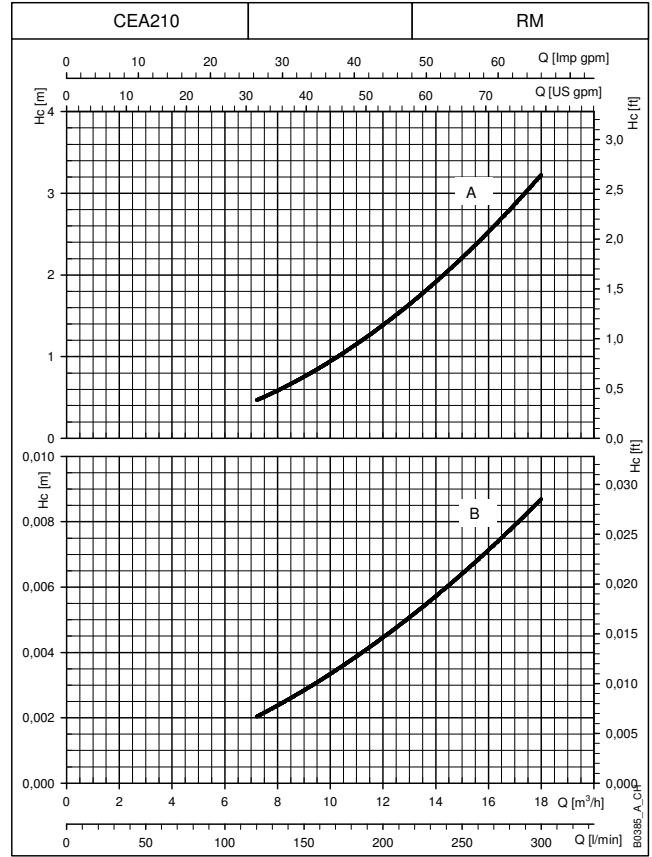
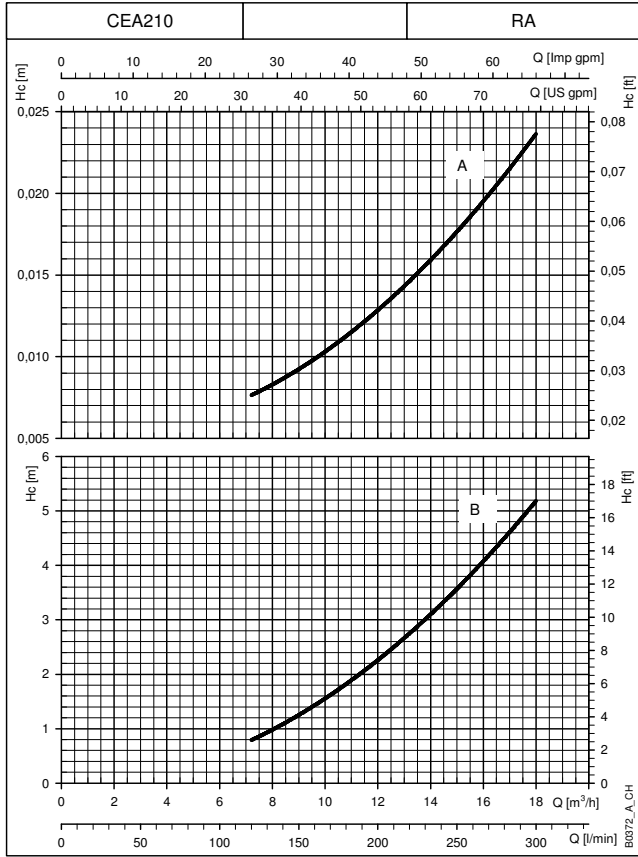

The declared curves are valid for liquids with density $\rho = 1 \text{ kg/dm}^3$ and kinematic viscosity $\nu = 1 \text{ mm}^2/\text{sec}$.
H_c (A): Pressure drop curve on delivery side of the pump. H_c (B): Pressure drop curve on suction side of the pump.
RA: check valve on suction side. RM: check valve on delivery side.
The pressure drops do not consider the distributed pressure drops on the manifold.

BOOSTER SETS GX5 AND GMD SERIES H_c PRESSURE DROP CURVE

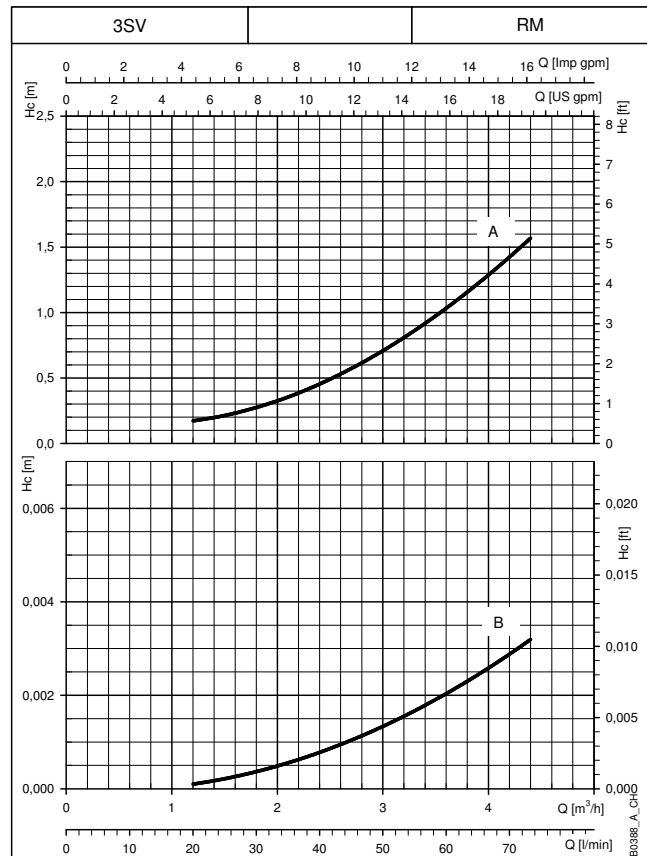
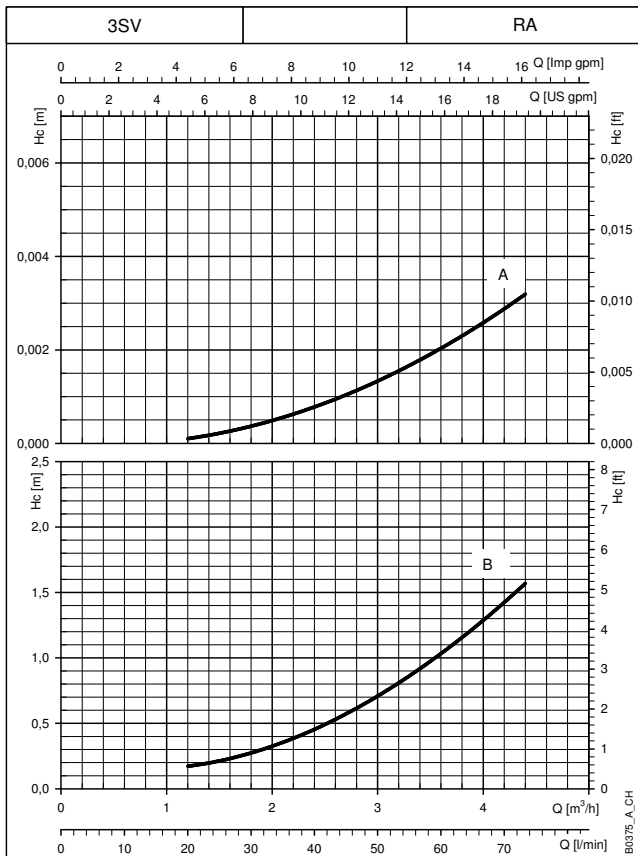
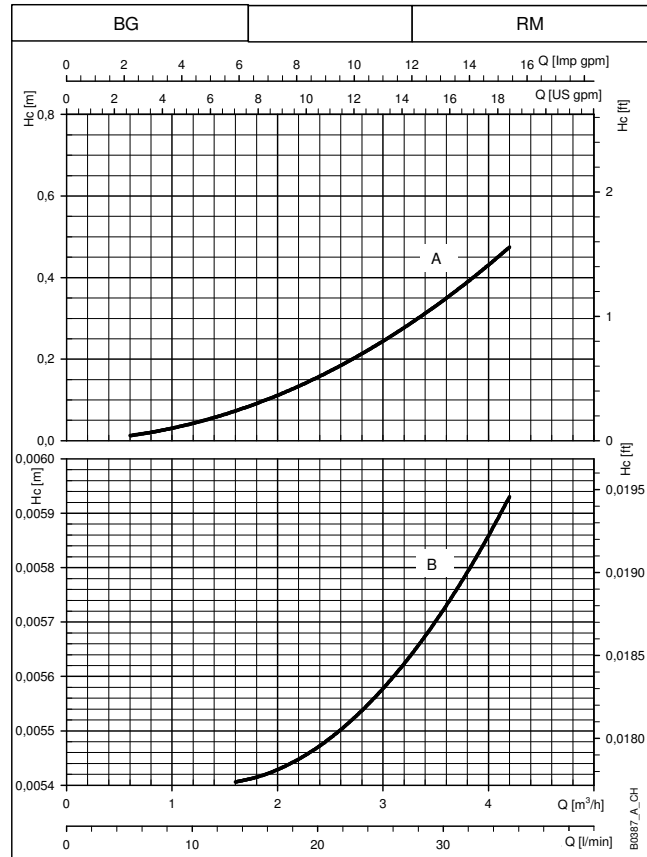
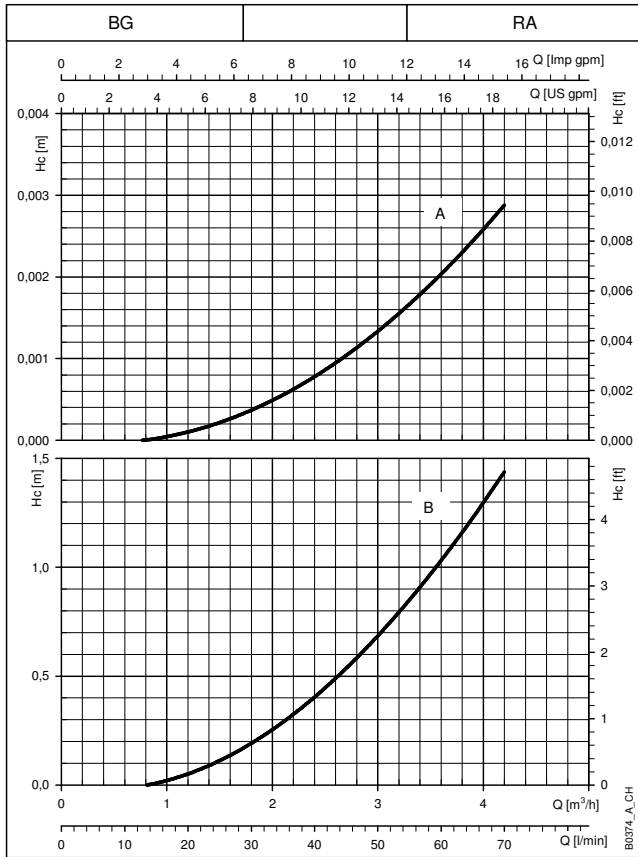

The declared curves are valid for liquids with density $\rho = 1 \text{ kg/dm}^3$ and kinematic viscosity $\nu = 1 \text{ mm}^2/\text{sec}$.
H_c (A): Pressure drop curve on delivery side of the pump. H_c (B): Pressure drop curve on suction side of the pump.
RA: check valve on suction side. RM: check valve on delivery side.
The pressure drops do not consider the distributed pressure drops on the manifold.

BOOSTER SETS GX5 AND GMD SERIES H_c PRESSURE DROP CURVE

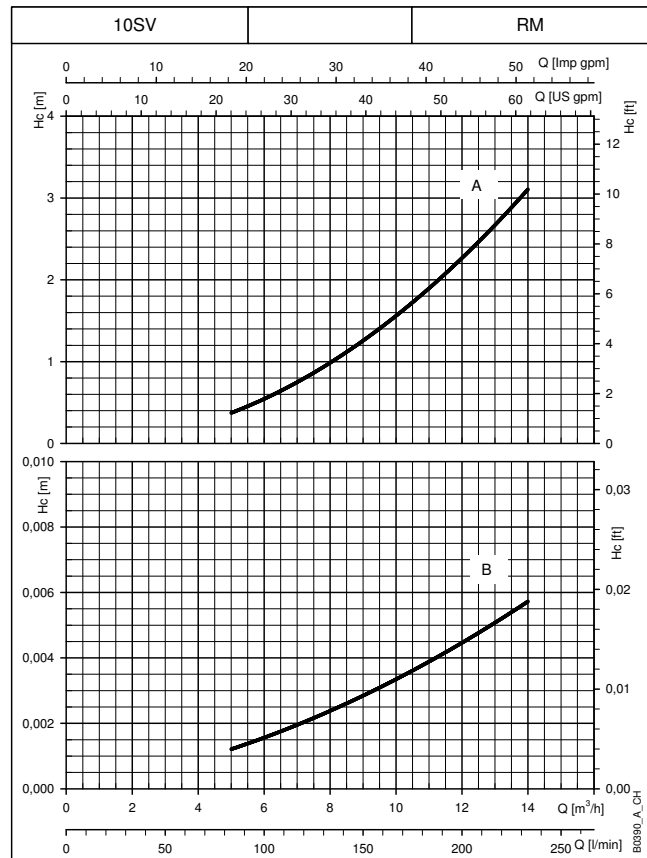
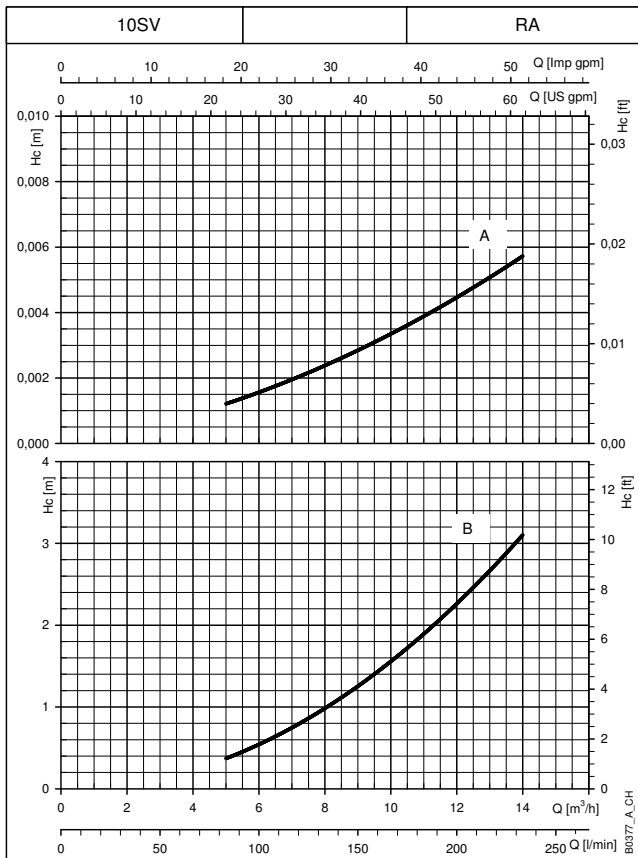
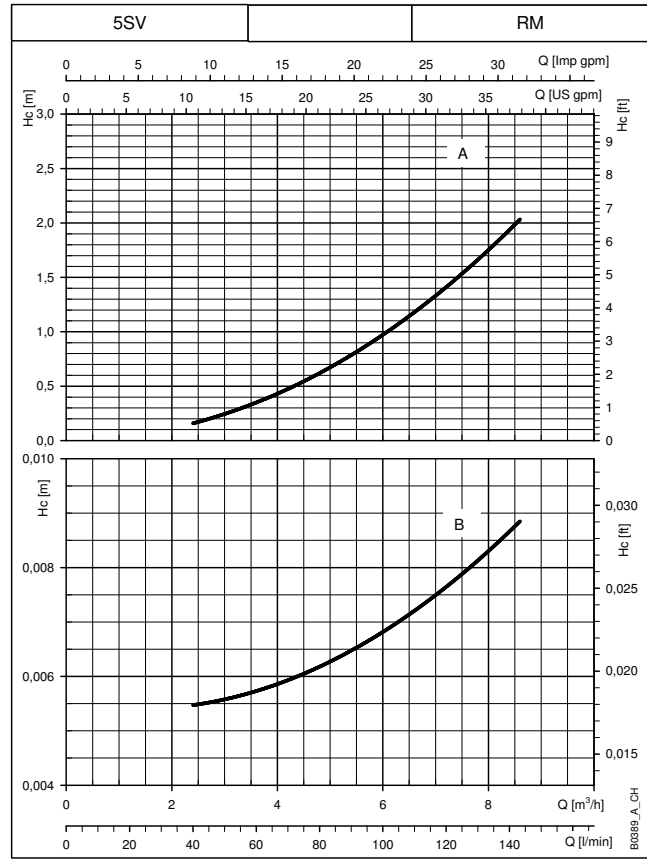
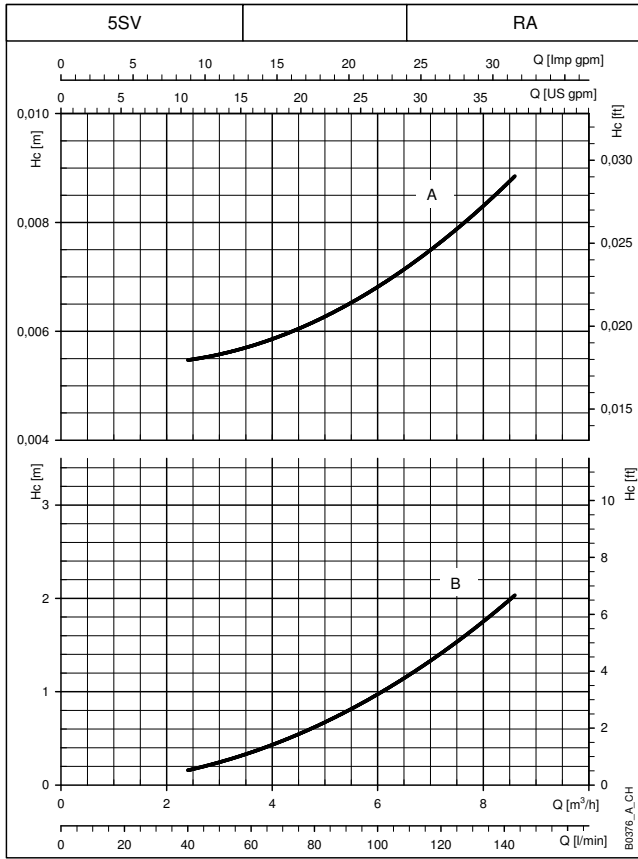

The declared curves are valid for liquids with density $\rho = 1 \text{ kg/dm}^3$ and kinematic viscosity $\nu = 1 \text{ mm}^2/\text{sec}$.
H_c (A): Pressure drop curve on delivery side of the pump. H_c (B): Pressure drop curve on suction side of the pump.
RA: check valve on suction side. RM: check valve on delivery side.
The pressure drops do not consider the distributed pressure drops on the manifold.

BOOSTER SETS GX5 AND GMD SERIES H_c PRESSURE DROP CURVE

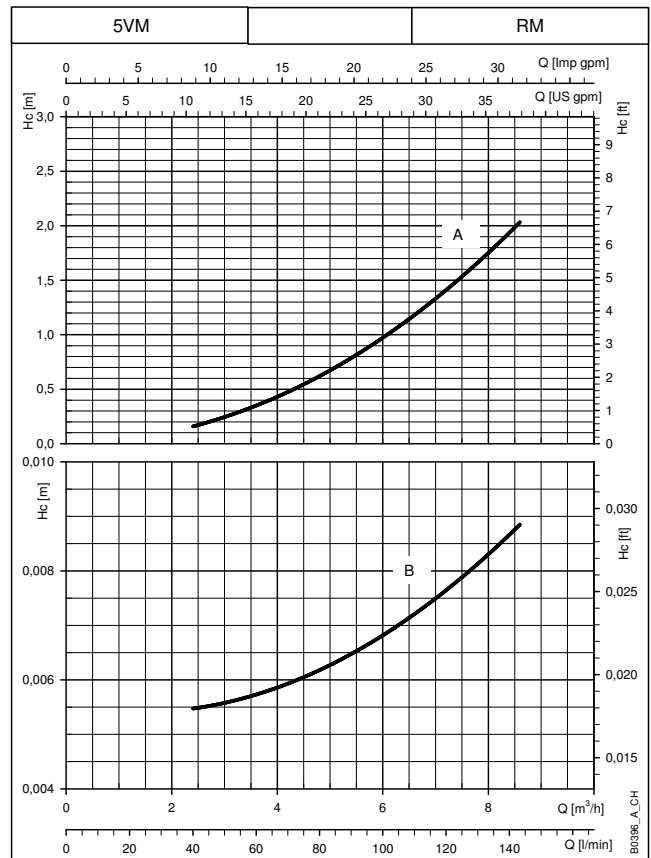
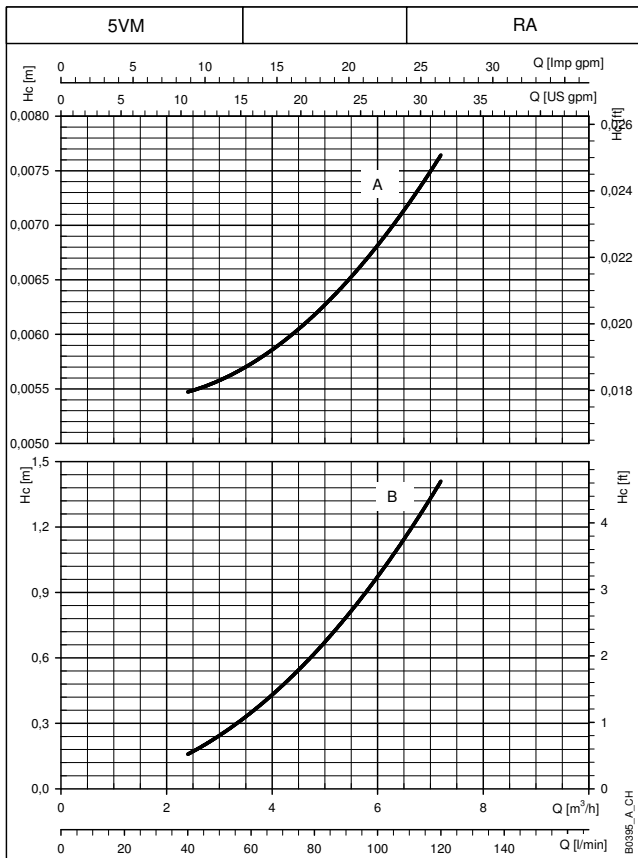
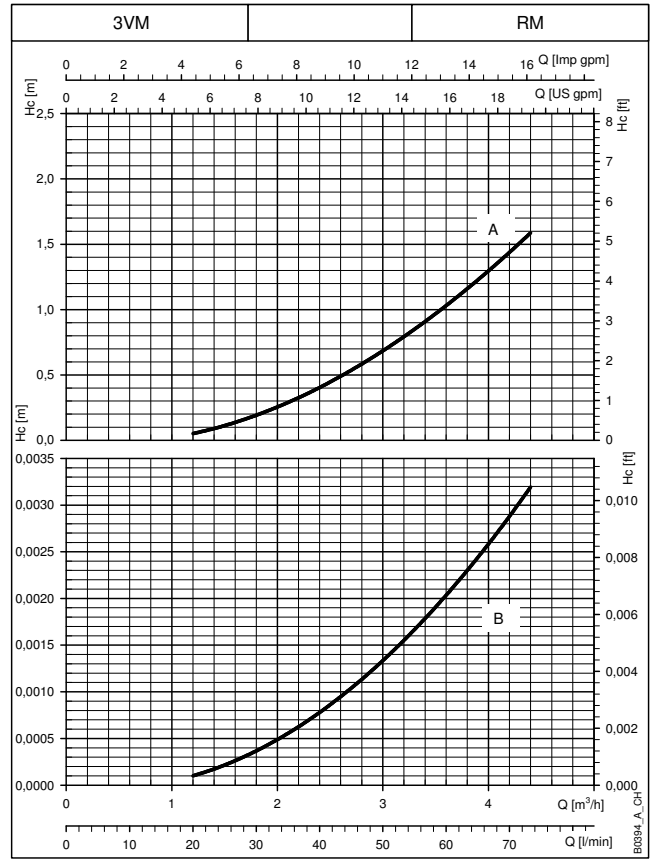
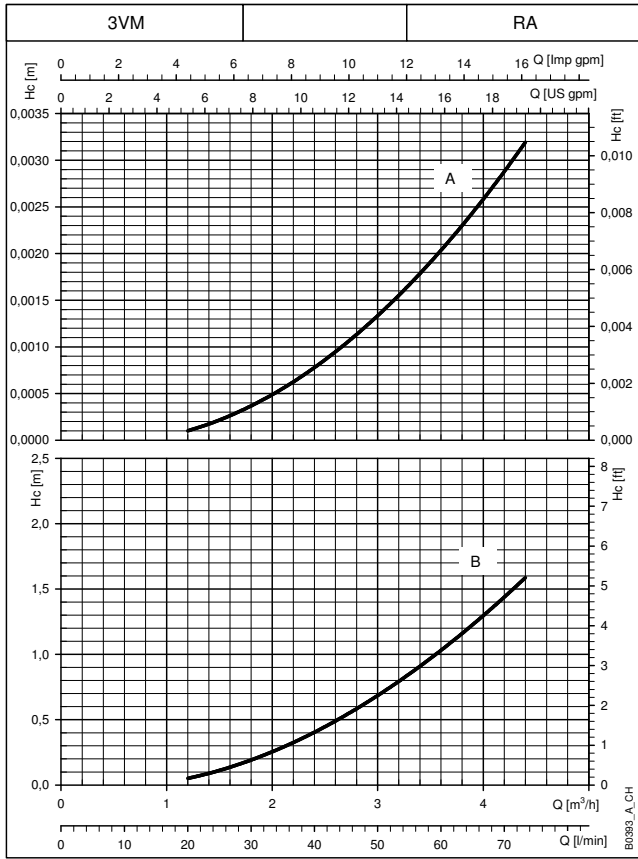

The declared curves are valid for liquids with density $\rho = 1 \text{ kg/dm}^3$ and kinematic viscosity $\nu = 1 \text{ mm}^2/\text{sec}$.
H_c (A): Pressure drop curve on delivery side of the pump. H_c (B): Pressure drop curve on suction side of the pump.
RA: check valve on suction side. RM: check valve on delivery side.
The pressure drops do not consider the distributed pressure drops on the manifold.

BOOSTER SETS GX5 AND GMD SERIES H_c PRESSURE DROP CURVE

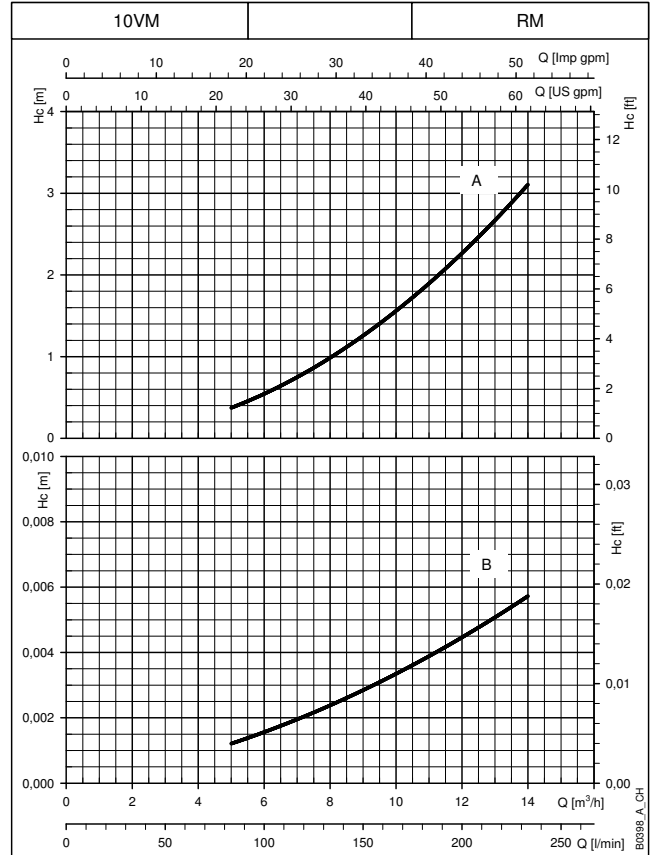
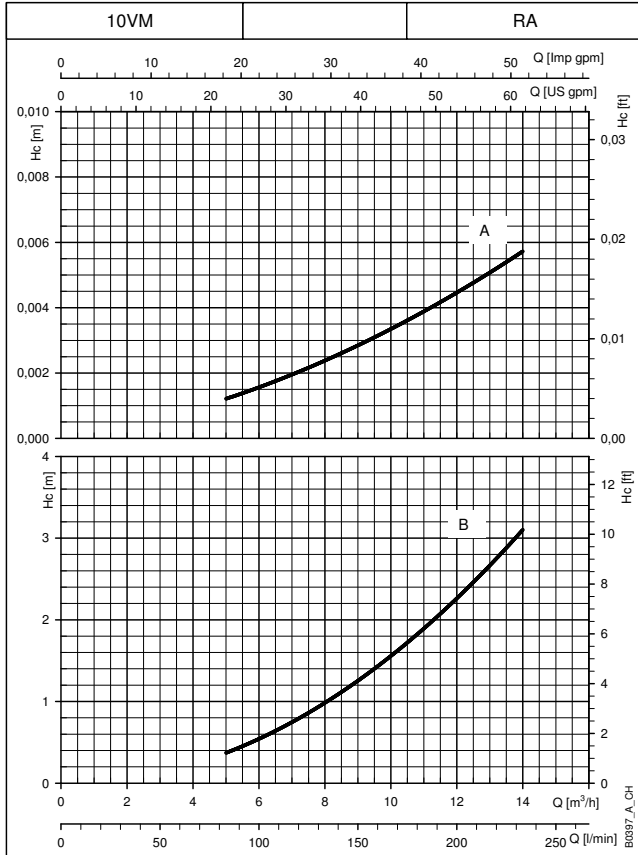

The declared curves are valid for liquids with density $\rho = 1 \text{ kg/dm}^3$ and kinematic viscosity $\nu = 1 \text{ mm}^2/\text{sec}$.
H_c (A): Pressure drop curve on delivery side of the pump. H_c (B): Pressure drop curve on suction side of the pump.
RA: check valve on suction side. RM: check valve on delivery side.
The pressure drops do not consider the distributed pressure drops on the manifold.

ACCESSORIES

EXPANSION VESSELS

Booster sets have delivery manifolds with attachments for the installation of 8 or 24 liter diaphragm expansion vessels (hydrotube).

The caps for sealing any unused attachments are supplied with the set.

Any large size vessels can be connected to the unused end of the delivery manifold. For proper sizing of the vessel, please refer to the technical appendix.

Kits featuring the following accessories are **available on request**:

- expansion vessel.
- on-off valve.
- instructions sheet.
- packing.

DIAPHRAGM EXPANSION VESSELS KITS

Volume Litres	PN bar	DIMENSIONS (mm)			Materials		
		ø A	B	Valve	Diaphragm	Vessel	Valve
8	8	205	390	1" FF	EPDM	Painted steel	Nickel-plated brass
24	8	270	555	1" FF	EPDM	Painted steel	Nickel-plated brass
24	10	270	555	1" FF	EPDM	Painted steel	Nickel-plated brass
24	16	270	555	1" FF	EPDM	Painted steel	Nickel-plated brass
24	10	270	575	1" FF	Butyl	Stainless steel	AISI 316 stainless steel
20	25	270	555	1" FF	EPDM	Painted steel	Nickel-plated brass

Gcom-vmb-en_c_td

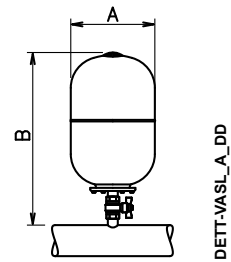

FLANGES KIT

Manifolds are supplied with threaded attachments and caps for sealing the unused ends.

For these manifolds, stainless steel AISI 304 or 316 flanges for connection to the system are available on request.

THREADED COUNTER FLANGES

KIT TYPE	DN	ø C	DIMENSIONS (mm)				HOLES			PN
			ø A	B	ø D	H	ø F	N°		
2"	50	Rp 2	125	16	165	24	18	4	25	
2" 1/2	65	Rp 2 1/2	145	16	185	23	18	4	16	
3"	80	Rp 3	160	17	200	27	18	8	16	

Gcom-ctf-tonde-f-en_a_td

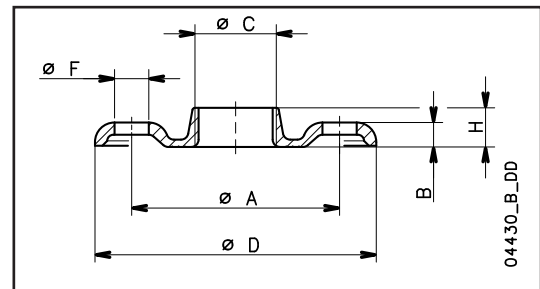

WELD-ON COUNTER FLANGES

KIT TYPE	DN	ø C	DIMENSIONS (mm)				HOLES			PN
			ø A	B	ø D	ø F	N°			
2"	50	61,5	125	20	165	18	4	16		
2"1/2	65	77,5	145	20	185	18	4	16		
3"	80	90,5	160	20	200	18	8	16		
4"	100	116	180	22	220	18	8	16		
5"	125	141,5	210	22	250	18	8	16		
6"	150	170,5	240	24	285	22	8	16		
8"	200	221,5	295	26	340	22	12	16		
10"	250	276,5	355	29	405	26	12	16		
12"	300	327,5	410	32	460	26	12	16		

Gcom-ctf-tonde-s-en_d_td

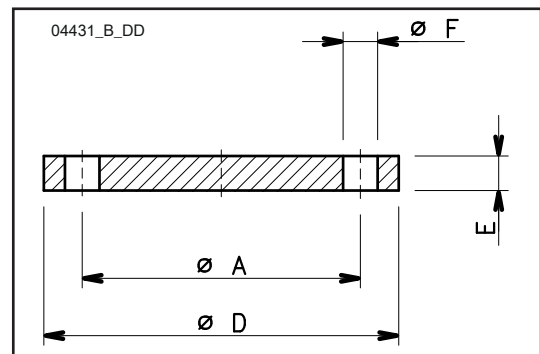

ANTI-VIBRATION JOINT KIT

Anti-vibration joints, or compensation joints, can be used to absorb deformations, expansions, pipe noise and reduce water hammering. They can also withstand a high level of vacuum, which enables the absorption of negative expansions due to depression.

Due to its elasticity, the material can deform or expand as necessary, making installation easier, simpler and quicker, even when the piping is not aligned.

The drinking water certificates are valid for the standard booster configuration. Please check with your Sales representative the drinking water certifications applicable for boosters equipped with fitted joints.

For more information, please contact the sales network.

RUBBER EXPANSION JOINT

EPDM RUBBER (*)		L	A	B	C	D
DN	Pmax bar (**)	(mm)	(mm)	(mm)	(mm)	(°)
1"	10	203	22	6	22	25
1"1/4	10	203	22	6	22	25
1"1/2	10	203	22	6	22	20
2"	10	203	22	6	22	15
2"1/2	10	203	22	6	22	12
3	10	203	22	6	22	10

EPDM RUBBER (*)		L	A	B	C	D
DN	Pmax bar (**)	(mm)	(mm)	(mm)	(mm)	(°)
32	16	152	13	9	13	15
40	16	152	13	9	13	15
50	16	152	13	9	13	15
65	16	152	13	9	13	15
80	16	152	13	9	13	15
100	16	152	19	13	13	15
125	16	152	19	13	13	15
150	16	152	19	13	13	15
200	16	152	19	13	19	15
250	16	203	25	16	19	15
300	10	203	25	16	19	15
350	10	203	25	16	19	15
400	9	203	25	16	19	15
450	9	203	25	16	19	15
500	9	203	25	16	19	15

* Metallic part in SS316

GD-316_JOINT_A_TD

** Maximum pressure permitted up to 80°C water

LEGEND

A = compression

B = extension

C = transverse

D = angular movement

NOTE. **A - B - C - D** can not be cumulative

PROTECTION SYSTEMS AGAINST DRY RUNNING

To avoid damaging the pumps, protection systems must be used to prevent it from dry running.

FLOAT SWITCH PROTECTION

The float switch system is used for supplies from open tanks. The float switch immersed in the tank must be connected to the control panel.

If there is no water, the float switch opens the electrical contact and the electric pumps stop.

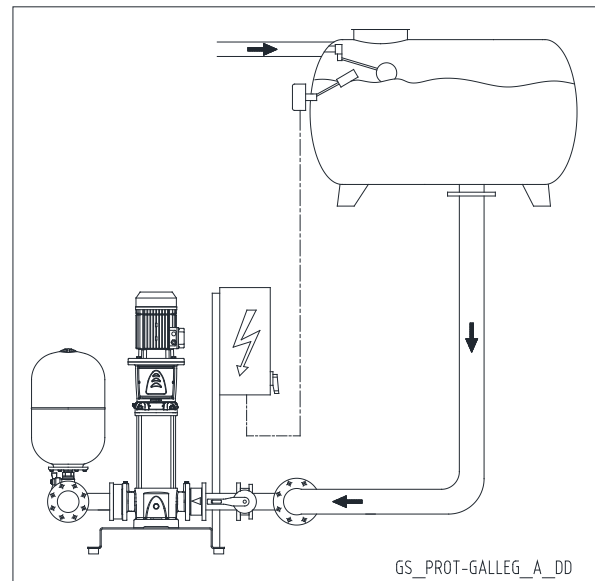

ELECTRODE PROBE PROTECTION

The system with electrode probes is used for supplies from open tanks or wells.

Three probes are directly connected to the electric module with adjustable sensitivity that can be installed in the control panel.

If there is no water, the control circuit opens the electrical contact and the electric pumps stop.

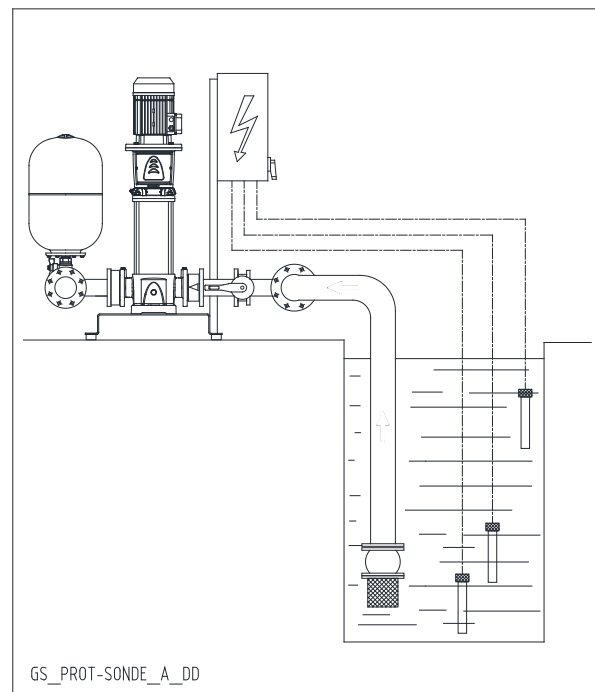

MINIMUM PRESSURE SWITCH PROTECTION

The system with minimum pressure switch is used for water supplies from pressurized networks or tanks. The pressure switch is connected to the control panel. In case of water shortage, it opens the electric contact, causing the stop of the electric pumps.

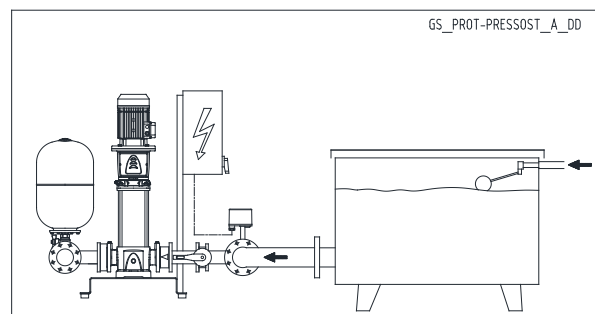

PROTECTION SENSOR AGAINST DRY RUNNING



Sensor for detecting the presence of water based on the optoelectronic principle, therefore non-invasive and with no moving parts. The sensor features an electronic contact (on/off) which stops the pump if there is no water in the seal area.

The sensor opens the electric contact if there is no water after they factory-set delay (10 seconds) elapses. The sensor is supplied as a kit complete with 2 meters of cable, an EPDM O-ring gasket and a stainless steel adapter.

General operating features

- The sensor can be fitted directly on the filling cap of the e-SV series of pumps.
- Operation is independent of the hardness and conductivity of the water. The sensor cannot detect frozen liquids.

Available in two power versions depending on foreseen use:

- 21÷27 Vac, universal solid state output for external relay at 24 Vac (21÷27 Vac, Max 50 mA).
- 15÷25 Vdc, NPN output at 25 V (10 mA) for HYDROVAR inverter.

Operating principle

Operation is based on the change in the refractive index on the surfaces.

The optic sensor comprises a glass cap (C) containing a transmitter (T) and an infrared receiver (R).

If there is no liquid, all the infrared light emitted by the transmitter is internally reflected by the surface of the glass cap of the receiver. The electronic contact will be open.

If liquid is present, the refractive index of the surface changes. Most of the infrared light emitted by the transmitter is dispersed in the liquid. The receiver receives less light and the electronic contact is closed.

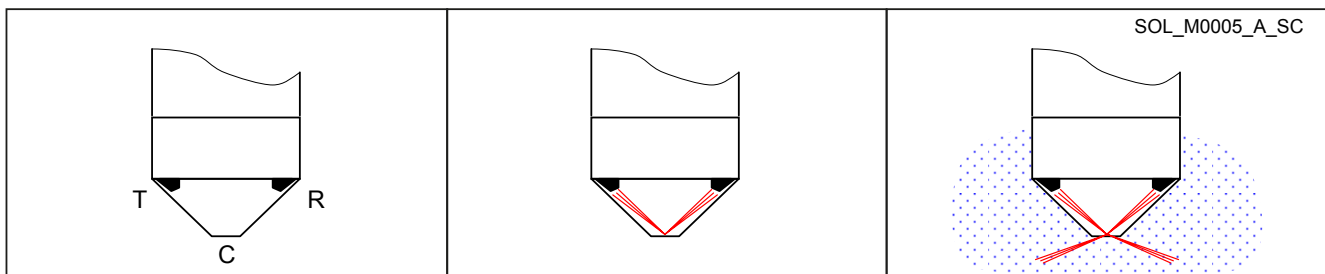

SPECIFICATIONS

- Materials:
 - Body in AISI 316L stainless steel
 - Glass optic cap
 - EPDM gasket
- Liquids: clean water, demi water. Operation is not affected by the hardness and conductivity of the liquid. To check the suitability of other liquids, contact the Lowara technical assistance service providing the characteristics of the liquid.
- Temperature of liquid: $-20^{\circ}\text{C} \div +120^{\circ}\text{C}$ (cannot be used to detect frozen liquids).
- Ambient temperature: $-5^{\circ}\text{C} \div +50^{\circ}\text{C}$
- Maximum pressure (PN): 25 bar
- Connector: 3/8" (3/8" x 1/2" adapter plug included in the Kit)
- Dimensions: 27x 60 mm
- IP55 protection
- Electrical characteristics:
 - Input voltage SENSOR KIT DRP-GP: 21÷27 Vac
SENSOR KIT DRP-HV: 15÷25 Vdc
 - Output SENSOR KIT DRP-GP: universal solid state 21÷27 Vac (50 mA) for 24 Vac external relay
SENSOR KIT DRP-HV: NPN 25 V (10 mA) for HYDROVAR inverter
 - Alarm delay: 10 seconds (factory setting)
 - FROR cable 4 x 0,34 mm² (PVC-CEI 20-22) 2 meters long.

WIRING DIAGRAM

The sensor can be directly mounted on the filling plug of the e-SV pumps.
For the 33, 46, 66, 92, 125SV series, the 3/8" x 1/2" adapter ring included in the kit must also be installed.

KIT SENSOR DRP-GP (code 109394610)

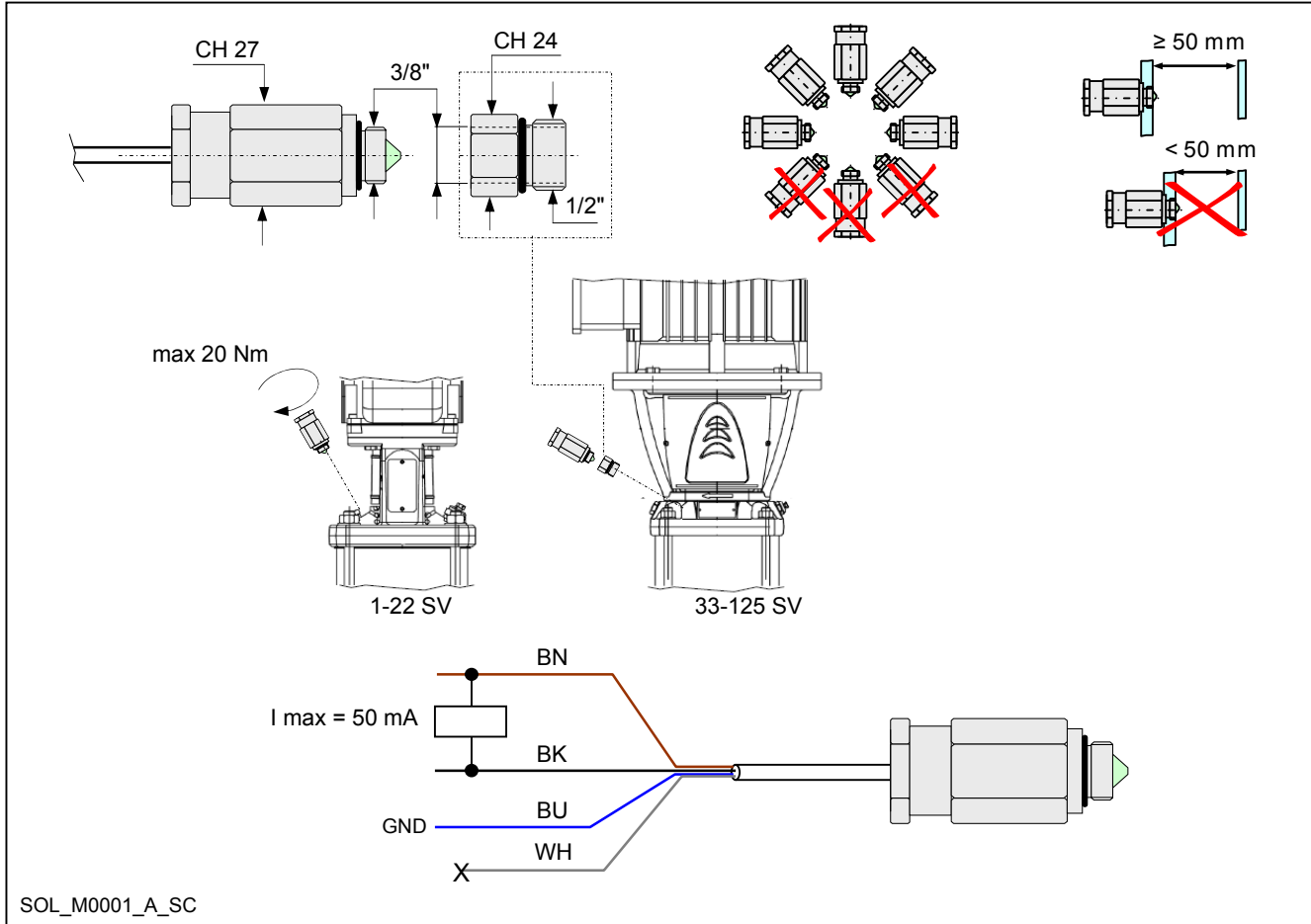

BK = Black
BN = Brown
BU = Blue
WH = White

OPTIMIZE™
CONDITION MONITORING TO OPTIMIZE YOUR BOTTOM LINE

The optimize™ modular condition monitoring solution provides health guidance and predictive maintenance advice for rotating and fixed assets such as pumps, motors, heat exchangers and steam traps. It periodically monitors system vibration and temperature and allows everyday users to access simple-to-use monitoring tools from iOS or Android mobile devices.

Using predictive analysis, optimize identifies potential problems with your equipment before they occur, to help you manage system reliability and maintenance. Information is monitored, collected, stored and analyzed in the optimize sensor. This allows you to understand the current health and historical trends of your assets, create maintenance reminders and generate detailed reports. As a result, you can perform preventative maintenance before issues become critical to uptime.



BENEFITS:

- Predictive maintenance to monitor the health of mechanical and electrical assets
- Asset management including asset location, size and manufacturing date
- System transparency to optimize reliability
- Optimized reporting that helps to simplify documentation, manage system maintenance and inform purchasing
- The ability to automatically share data with multiple local users

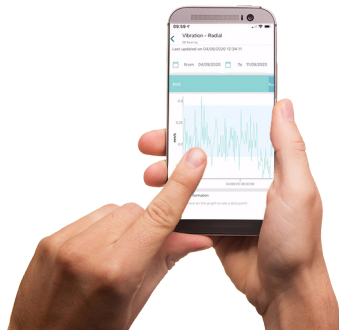

- Conveniently monitor system conditions on our simple-to-use mobile application

INDUSTRIES:

- Commercial Building Services
- Manufacturing
- Agriculture
- Water Utilities

APPLICATIONS:

- Monitoring the vibration of pumps and motors
- Monitoring the temperature of pump bearings
- Monitoring the temperature of motors to prevent overheating and winding damage
- Monitoring the performance of heat exchangers
- And more

OPTIMIZE™ CONDITION MONITORING AND OPTIMIZATION SPECIFICATIONS

Surface Temperature Measurement	
Measurement range	-20°C to +135°C (-4°F to +275°F)
Measurement method	Non-contact infrared laser
Minor gradient accuracy (0°C to 25°C gradient)	+/- 1°C
Moderate gradient accuracy (25°C to 50°C gradient)	+/- 2°C
Large gradient accuracy (50°C to 100°C gradient)	+/- 4°C
Vibration Measurement	
Frequency range	5Hz to 1,100Hz
Measurement method	Independent 3-axis
Primary output (per axis)	Single value RMS
Other outputs	Kurtosis and FFT
Vibration limit (max acceleration)	16g
Threshold standard (Global)	ISO 10816-7
Threshold standard (North America)	ANSI/HI 9.6.4
Power	
Batteries (replaceable)	(2) 3.6V AA, 2400mAh, Lithium
Battery life (using default sampling rate at 25°C)	3 to 5 years
Default sampling rate	1 sample per 30 minutes
Available sampling rates (one sample per unit of time)	10 seconds to 12 hours
Wireless Communication	
Network type	Bluetooth® Low Energy 5.01
Connection range (without interference)	30 meters (100 feet)
Environmental	
Ambient operating range	-20°C to +50°C (-4°F to +122°F)
Storage temperature (5 to 95% humidity non-condensing)	-25°C to +65°C (-13°F to +149°F)
Protection rating	IP56, NEMA 4
Physical Properties	
Weight	145g (0.32 lbs.)
Status	LED
Mounting method (standard)	Magnetic (16mm potted magnets)
Mounting method (optional)	Drill and tap with plate
Certifications	
Certifications	CE, FCC, UL
Intended use (environments)	Non-hazardous, non-corrosive
Part Numbers	
optimize (standard sensor)	P2007000
optimize battery replacement kit	P2007030
optimize optional flat plate mounting kit	P2007031

¹Backwards compatible up to Bluetooth® Low Energy 4.2

opt-en_a_sc

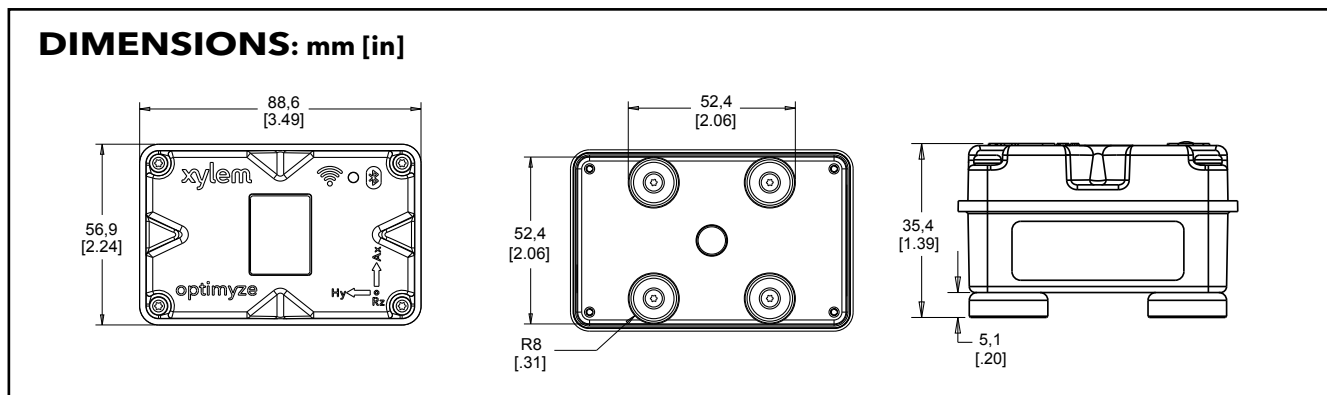

TECHNICAL APPENDIX

VAPOUR PRESSURE
VAPOUR PRESSURE p_s AND ρ DENSITY OF WATER TABLE

t °C	T K	p_s bar	ρ kg/dm ³	t °C	T K	p_s bar	ρ kg/dm ³	t °C	T K	p_s bar	ρ kg/dm ³
0	273,15	0,00611	0,9998	55	328,15	0,15741	0,9857	120	393,15	1,9854	0,9429
1	274,15	0,00657	0,9999	56	329,15	0,16511	0,9852	122	395,15	2,1145	0,9412
2	275,15	0,00706	0,9999	57	330,15	0,17313	0,9846	124	397,15	2,2504	0,9396
3	276,15	0,00758	0,9999	58	331,15	0,18147	0,9842	126	399,15	2,3933	0,9379
4	277,15	0,00813	1,0000	59	332,15	0,19016	0,9837	128	401,15	2,5435	0,9362
5	278,15	0,00872	1,0000	60	333,15	0,1992	0,9832	130	403,15	2,7013	0,9346
6	279,15	0,00935	1,0000	61	334,15	0,2086	0,9826	132	405,15	2,867	0,9328
7	280,15	0,01001	0,9999	62	335,15	0,2184	0,9821	134	407,15	3,041	0,9311
8	281,15	0,01072	0,9999	63	336,15	0,2286	0,9816	136	409,15	3,223	0,9294
9	282,15	0,01147	0,9998	64	337,15	0,2391	0,9811	138	411,15	3,414	0,9276
10	283,15	0,01227	0,9997	65	338,15	0,2501	0,9805	140	413,15	3,614	0,9258
11	284,15	0,01312	0,9997	66	339,15	0,2615	0,9799	145	418,15	4,155	0,9214
12	285,15	0,01401	0,9996	67	340,15	0,2733	0,9793	155	428,15	5,433	0,9121
13	286,15	0,01497	0,9994	68	341,15	0,2856	0,9788	160	433,15	6,181	0,9073
14	287,15	0,01597	0,9993	69	342,15	0,2984	0,9782	165	438,15	7,008	0,9024
15	288,15	0,01704	0,9992	70	343,15	0,3116	0,9777	170	433,15	7,920	0,8973
16	289,15	0,01817	0,9990	71	344,15	0,3253	0,9770	175	448,15	8,924	0,8921
17	290,15	0,01936	0,9988	72	345,15	0,3396	0,9765	180	453,15	10,027	0,8869
18	291,15	0,02062	0,9987	73	346,15	0,3543	0,9760	185	458,15	11,233	0,8815
19	292,15	0,02196	0,9985	74	347,15	0,3696	0,9753	190	463,15	12,551	0,8760
20	293,15	0,02337	0,9983	75	348,15	0,3855	0,9748	195	468,15	13,987	0,8704
21	294,15	0,24850	0,9981	76	349,15	0,4019	0,9741	200	473,15	15,550	0,8647
22	295,15	0,02642	0,9978	77	350,15	0,4189	0,9735	205	478,15	17,243	0,8588
23	296,15	0,02808	0,9976	78	351,15	0,4365	0,9729	210	483,15	19,077	0,8528
24	297,15	0,02982	0,9974	79	352,15	0,4547	0,9723	215	488,15	21,060	0,8467
25	298,15	0,03166	0,9971	80	353,15	0,4736	0,9716	220	493,15	23,198	0,8403
26	299,15	0,03360	0,9968	81	354,15	0,4931	0,9710	225	498,15	25,501	0,8339
27	300,15	0,03564	0,9966	82	355,15	0,5133	0,9704	230	503,15	27,976	0,8273
28	301,15	0,03778	0,9963	83	356,15	0,5342	0,9697	235	508,15	30,632	0,8205
29	302,15	0,04004	0,9960	84	357,15	0,5557	0,9691	240	513,15	33,478	0,8136
30	303,15	0,04241	0,9957	85	358,15	0,5780	0,9684	245	518,15	36,523	0,8065
31	304,15	0,04491	0,9954	86	359,15	0,6011	0,9678	250	523,15	39,776	0,7992
32	305,15	0,04753	0,9951	87	360,15	0,6249	0,9671	255	528,15	43,246	0,7916
33	306,15	0,05029	0,9947	88	361,15	0,6495	0,9665	260	533,15	46,943	0,7839
34	307,15	0,05318	0,9944	89	362,15	0,6749	0,9658	265	538,15	50,877	0,7759
35	308,15	0,05622	0,9940	90	363,15	0,7011	0,9652	270	543,15	55,058	0,7678
36	309,15	0,05940	0,9937	91	364,15	0,7281	0,9644	275	548,15	59,496	0,7593
37	310,15	0,06274	0,9933	92	365,15	0,7561	0,9638	280	553,15	64,202	0,7505
38	311,15	0,06624	0,9930	93	366,15	0,7849	0,9630	285	558,15	69,186	0,7415
39	312,15	0,06991	0,9927	94	367,15	0,8146	0,9624	290	563,15	74,461	0,7321
40	313,15	0,07375	0,9923	95	368,15	0,8453	0,9616	295	568,15	80,037	0,7223
41	314,15	0,07777	0,9919	96	369,15	0,8769	0,9610	300	573,15	85,927	0,7122
42	315,15	0,08198	0,9915	97	370,15	0,9094	0,9602	305	578,15	92,144	0,7017
43	316,15	0,09639	0,9911	98	371,15	0,9430	0,9596	310	583,15	98,70	0,6906
44	317,15	0,09100	0,9907	99	372,15	0,9776	0,9586	315	588,15	105,61	0,6791
45	318,15	0,09582	0,9902	100	373,15	1,0133	0,9581	320	593,15	112,89	0,6669
46	319,15	0,10086	0,9898	102	375,15	1,0878	0,9567	325	598,15	120,56	0,6541
47	320,15	0,10612	0,9894	104	377,15	1,1668	0,9552	330	603,15	128,63	0,6404
48	321,15	0,11162	0,9889	106	379,15	1,2504	0,9537	340	613,15	146,05	0,6102
49	322,15	0,11736	0,9884	108	381,15	1,3390	0,9522	350	623,15	165,35	0,5743
50	323,15	0,12335	0,9880	110	383,15	1,4327	0,9507	360	633,15	186,75	0,5275
51	324,15	0,12961	0,9876	112	385,15	1,5316	0,9491	370	643,15	210,54	0,4518
52	325,15	0,13613	0,9871	114	387,15	1,6362	0,9476	374,15	647,30	221,20	0,3154
53	326,15	0,14293	0,9862	116	389,15	1,7465	0,9460				
54	327,15	0,15002	0,9862	118	391,15	1,8628	0,9445				

TANK

CHOOSING AND SIZING THE SURGE TANK

The purpose of the surge tank is to limit the number of hourly starts of the pumps, placing part of its stock of water, which is maintained under pressure by the air above it, at the disposal of the system.

The surge tank can be of the air cushion or expansion vessel type.

In the air cushion version there is no clear separation between air and water.

Since part of the air tends to mix with water, it is necessary to restore it by means of air supply units or a compressor.

In the expansion vessel version, neither air supply units nor compressor are needed, as contact between air and water is prevented by a flexible expansion vessel inside the tank.

The following method, which is used to determine the volume of a surge tank, is valid both for horizontal and vertical surge tanks.

When calculating the volume of the surge tank, it is generally sufficient to consider the first pump only.

EXPANSION VESSEL

If you decide to use an expansion vessel, the volume will be lower than that of the air-cushion tank. It can be calculated with the following formula:

$$V_m = \frac{Q_p}{4 \times Z} \times \frac{1}{1 - \frac{(P_{min} - 2)}{P_{max}}}$$

where:

V_m = Total volume of the air-cushion surge tank in m^3

Q_p = Average pump flow rate in m^3/h

P_{max} = Maximum pressure setting (wcm)

P_{min} = Minimum pressure setting (wcm)

Z = Maximum number of starts per hour allowed by the motor

Example:

22SV10F110T electric pump

P_{max} = 23 wcm

P_{min} = 15 wcm

Q_p = 20 m^3/h

Z = 25

$$V_m = \frac{Q_p}{4 \times Z} \times \frac{1}{1 - \frac{(P_{min} - 2)}{P_{max}}} = 0,46 \text{ m}^3$$

A 500-litre surge tank is therefore required.

TANK

PERFORMANCE WITH VARYING SPEED: EQUIVALENCE RELATIONS

Fitting the electric pump with a frequency converter makes it possible to vary the pump rotation speed, normally according to the system pressure parameter. **Variations in electric pump speed** result in **modified performances** according to the equivalence relations.

Flow rate	$\frac{Q1}{Q2} = \left[\frac{n1}{n2} \right]$
Head	$\frac{H1}{H2} = \left[\frac{n1}{n2} \right]^2$
Power	$\frac{P1}{P2} = \left[\frac{n1}{n2} \right]^3$

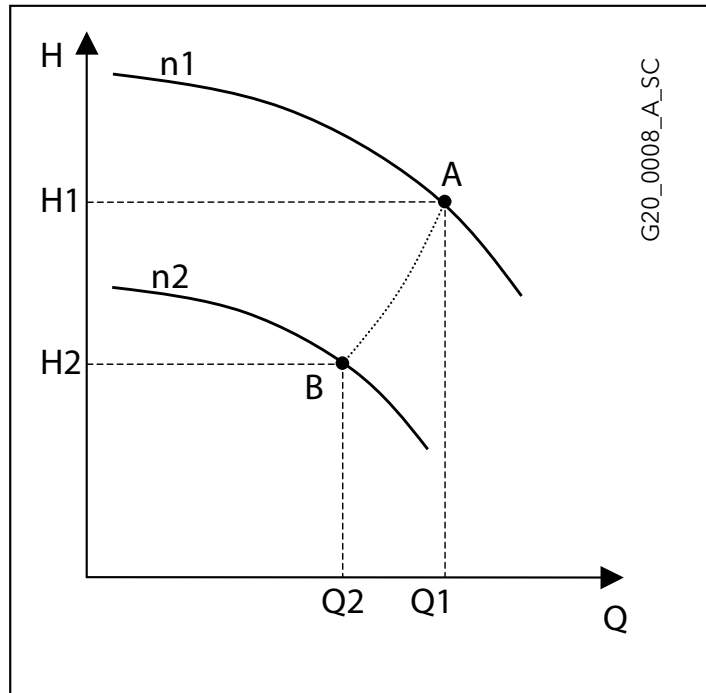

n1 = initial speed; n2= speed required.
 Q1 = initial flow rate; Q2= flow rate required.
 H1 = initial head; H2= head required.
 P1 = initial power; P2= power required

Frequency ratios can be used instead of speed in practical applications, keeping 30 Hz as the bottom limit.

Example : 2-pole 50 Hz electric pump n1 =2900 rpm (point A)

Flow rate (A) = 100 l/min; Head (A) = 50 m

By reducing the frequency to 30 Hz the speed is reduced to approx. n2 = 1740 rpm (point B)

Flow rate (B) = 60 l/min; Head (B) = 18 m

The power of the new work point B is cut to about 22% of the initial power.

SIZING THE EXPANSION VESSEL IN SYSTEMS WITH SPEED VARIATION

Variable speed booster sets need **smaller expansion vessel** compared to traditional systems. Generally speaking, the vessel with a liter capacity of just 10% of the nominal capacity of a single pump, expressed in liters per minute, is needed.

The **gradual starting** of the pumps controlled by the frequency converters reduces the need to limit the number of hourly starts; the main purpose of the vessel is to compensate for small system losses, stabilize the pressure and make up for pressure variations caused by sudden demand.

Make the following calculation:

Set made up of three electric pumps, each with a maximum flow rate of 400 l/min, for a total capacity of 1200 l/min.

The **volume** required for the vessel is 40 liters. This size can be obtained by using two 24-litre vessels mounted directly onto the set's manifold.

The calculation establishes the minimum value needed for proper operation.

TABLE OF FLOW RESISTANCE IN 100 m OF STRAIGHT CAST IRON PIPELINE (HAZEN-WILLIAMS FORMULA C=100)

FLOW RATE		NOMINAL DIAMETER in mm and inches																													
m ³ /h	l/min	15	20	25	32	40	50	65	80	100	125	150	175	200	250	300	350	400													
		1/2"	3/4"	1"	1 1/4"	1 1/2"	2	2 1/2"	3"	4"	5"	6"	7"	8"	10"	12"	14"	16"													
0,6	10	v hr	0,94 16	0,53 3,94	0,34 1,33	0,21 0,40	0,13 0,13	The hr values must be multiplied by: 0,71 for galvanized or painted steel pipes 0,54 for stainless steel or copper pipes 0,47 for PVC or PE pipes																							
0,9	15	v hr	1,42 33,9	0,80 8,35	0,51 2,82	0,31 0,85	0,20 0,29																								
1,2	20	v hr	1,89 57,7	1,06 14,21	0,68 4,79	0,41 1,44	0,27 0,49													0,17 0,16											
1,5	25	v hr	2,36 87,2	1,33 21,5	0,85 7,24	0,52 2,18	0,33 0,73													0,21 0,25											
1,8	30	v hr	2,83 122	1,59 30,1	1,02 10,1	0,62 3,05	0,40 1,03													0,25 0,35											
2,1	35	v hr	3,30 162	1,86 40,0	1,19 13,5	0,73 4,06	0,46 1,37													0,30 0,46											
2,4	40	v hr		2,12 51,2	1,36 17,3	0,83 5,19	0,53 1,75													0,34 0,59	0,20 0,16										
3	50	v hr		2,65 77,4	1,70 26,1	1,04 7,85	0,66 2,65													0,42 0,89	0,25 0,25										
3,6	60	v hr		3,18 108	2,04 36,6	1,24 11,0	0,80 3,71													0,51 1,25	0,30 0,35										
4,2	70	v hr		3,72 144	2,38 48,7	1,45 14,6	0,93 4,93													0,59 1,66	0,35 0,46										
4,8	80	v hr		4,25 185	2,72 62,3	1,66 18,7	1,06 6,32													0,68 2,13	0,40 0,59										
5,4	90	v hr			3,06 77,5	1,87 23,3	1,19 7,85													0,76 2,65	0,45 0,74	0,30 0,27									
6	100	v hr			3,40 94,1	2,07 28,3	1,33 9,54													0,85 3,22	0,50 0,90	0,33 0,33									
7,5	125	v hr			4,25 142	2,59 42,8	1,66 14,4													1,06 4,86	0,63 1,36	0,41 0,49									
9	150	v hr				3,11 59,9	1,99 20,2													1,27 6,82	0,75 1,90	0,50 0,69	0,32 0,23								
10,5	175	v hr				3,63 79,7	2,32 26,9													1,49 9,07	0,88 2,53	0,58 0,92	0,37 0,31								
12	200	v hr				4,15 102	2,65 34,4													1,70 11,6	1,01 3,23	0,66 1,18	0,42 0,40								
15	250	v hr				5,18 154	3,32 52,0													2,12 17,5	1,26 4,89	0,83 1,78	0,53 0,60	0,34 0,20							
18	300	v hr				3,98 72,8	2,55 24,6	1,51 6,85	1,00 2,49	0,64 0,84	0,41 0,28																				
24	400	v hr				5,31 124	3,40 41,8	2,01 11,66	1,33 4,24	0,85 1,43	0,54 0,48	0,38 0,20	0,38																		
30	500	v hr				6,63 187	4,25 63,2	2,51 17,6	1,66 6,41	1,06 2,16	0,68 0,73	0,47 0,30																			
36	600	v hr					5,10 88,6	3,02 24,7	1,99 8,98	1,27 3,03	0,82 1,02	0,57 0,42	0,42	0,20																	
42	700	v hr					5,94 118	3,52 32,8	2,32 11,9	1,49 4,03	0,95 1,36	0,66 0,56	0,49	0,26																	
48	800	v hr					6,79 151	4,02 42,0	2,65 15,3	1,70 5,16	1,09 1,74	0,75 0,72	0,55	0,34																	
54	900	v hr					7,64 188	4,52 52,3	2,99 19,0	1,91 6,41	1,22 2,16	0,85 0,89	0,62	0,42																	
60	1000	v hr						5,03 63,5	3,32 23,1	2,12 7,79	1,36 2,63	0,94 1,08	0,69	0,51	0,53																
75	1250	v hr						6,28 96,0	4,15 34,9	2,65 11,8	1,70 3,97	1,18	0,87	0,66	0,40																
90	1500	v hr						7,54 134	4,98 48,9	3,18 16,5	2,04 5,57	1,42	1,04	0,80	0,56																
105	1750	v hr						8,79 179	5,81 65,1	3,72 21,9	2,38 7,40	1,65	1,21	0,93	0,75																
120	2000	v hr							6,63 83,3	4,25 28,1	2,72 9,48	1,89	1,39	1,06	0,68	0,32															
150	2500	v hr							8,29 126	5,31 42,5	3,40 14,3	2,36	1,73	1,33	0,85	0,49															
180	3000	v hr							6,37 59,5	4,08 20,1	2,83 8,26	2,08	1,59	1,02	0,71	0,28															
210	3500	v hr							7,43 79,1	4,76 26,7	3,30 11,0	2,43	1,86	1,19	0,83	0,38															
240	4000	v hr							8,49 101	5,44 34,2	3,77 14,1	2,77	2,12	1,36	0,94	0,48															
300	5000	v hr								6,79 51,6	4,72 21,2	3,47	2,65	1,70	1,18	0,73															
360	6000	v hr								8,15 72,3	5,66 29,8	4,16	3,18	2,04	1,42	0,94															
420	7000	v hr									7,55 50,7	5,55	4,25	2,72	1,89	1,39	1,65	1,21	0,64												
480	8000	v hr									6,61 39,6	4,85	3,72	2,38	1,65	1,39	1,02	0,64	0,82												
540	9000	v hr									8,49 63,0	6,24	4,78	3,06	2,12	1,56	1,02	0,65	1,19												
600	10000	v hr										6,93	5,31	3,40	2,36	1,73	1,33	0,65	1,33												

hr = flow resistance for 100 m of straight pipeline (m)
V = water speed (m/s)

G-at-pct-en_b_th

FLOW RESISTANCE

TABLE OF FLOW RESISTANCE IN BENDS, VALVES AND GATES

The flow resistance is calculated using the equivalent pipeline length method according to the table below:

ACCESSORY TYPE	DN											
	25	32	40	50	65	80	100	125	150	200	250	300
	Equivalent pipeline length (m)											
45° bend	0,2	0,2	0,4	0,4	0,6	0,6	0,9	1,1	1,5	1,9	2,4	2,8
90° bend	0,4	0,6	0,9	1,1	1,3	1,5	2,1	2,6	3,0	3,9	4,7	5,8
90° smooth bend	0,4	0,4	0,4	0,6	0,9	1,1	1,3	1,7	1,9	2,8	3,4	3,9
Union tee or cross	1,1	1,3	1,7	2,1	2,6	3,2	4,3	5,3	6,4	7,5	10,7	12,8
Gate valve	-	-	-	0,2	0,2	0,2	0,4	0,4	0,6	0,9	1,1	1,3
Foot check valve	1,1	1,5	1,9	2,4	3,0	3,4	4,7	5,9	7,4	9,6	11,8	13,9
Non return valve	1,1	1,5	1,9	2,4	3,0	3,4	4,7	5,9	7,4	9,6	11,8	13,9

G-a-pcv-en_b_th

The table is valid for the Hazen Williams coefficient $C=100$ (cast iron pipework)
 for galvanized steel or painted steel multiply the values by 0,71;
 for stainless steel and copper multiply the values by 0,54;
 for Pvc and PE multiply the values by 0,47.

When the **equivalent pipeline length** has been determined, the flow resistance is obtained from the table in the previous page.

The values given are guideline values which are bound to vary slightly according to the model, especially for gate valves and non-return valves, for which it is a good idea to check the values supplied by manufacturers.

VOLUMETRIC CAPACITY

Litres per minute l/min	Cubic metres per hour m ³ /h	Cubic feet per hour ft ³ /h	Cubic feet per minute ft ³ /min	Imperial gallon per minute Imp. gal/min	U.S. gallon per minute US gal/min
1,000	0,0600	2,1189	0,0353	0,2200	0,2642
16,6667	1,0000	35,3147	0,5886	3,6662	4,4029
0,4719	0,0283	1,0000	0,0167	0,1038	0,1247
28,3168	1,6990	60,0000	1,0000	6,2288	7,4805
4,5461	0,2728	9,6326	0,1605	1,0000	1,2009
3,7854	0,2271	8,0208	0,1337	0,8327	1,0000

PRESSURE AND HEAD

Newton per square metre N/m ²	kilo Pascal kPa	bar bar	Pound force per square inch psi	Metre of water m H ₂ O	Millimetre of mercury mm Hg
1,0000	0,0010	1 x 10 ⁻⁵	1,45 x 10 ⁻⁴	1,02 x 10 ⁻⁴	0,0075
1 000,0000	1,0000	0,0100	0,1450	0,1020	7,5006
1 x 10 ⁵	100,0000	1,0000	14,5038	10,1972	750,0638
6 894,7570	6,8948	0,0689	1,0000	0,7031	51,7151
9 806,6500	9,8067	0,0981	1,4223	1,0000	73,5561
133,3220	0,1333	0,0013	0,0193	0,0136	1,0000

LENGTH

Millimetre mm	Centimetre cm	Metre m	Inch in	Foot ft	Yard yd
1,0000	0,1000	0,0010	0,0394	0,0033	0,0011
10,0000	1,0000	0,0100	0,3937	0,0328	0,0109
1 000,0000	100,0000	1,0000	39,3701	3,2808	1,0936
25,4000	2,5400	0,0254	1,0000	0,0833	0,0278
304,8000	30,4800	0,3048	12,0000	1,0000	0,3333
914,4000	91,4400	0,9144	36,0000	3,0000	1,0000

VOLUME

Cubic metre m ³	Litre L	Millilitre ml	Imperial gallon imp. gal.	U.S. gallon US gal.	Cubic foot ft ³
1,0000	1 000,0000	1 x 10 ⁶	219,9694	264,1720	35,3147
0,0010	1,0000	1 000,0000	0,2200	0,2642	0,0353
1 x 10 ⁻⁶	0,0010	1,0000	2,2 x 10 ⁻⁴	2,642 x 10 ⁻⁴	3,53 x 10 ⁻⁵
0,0045	4,5461	4 546,0870	1,0000	1,2009	0,1605
0,0038	3,7854	3 785,4120	0,8327	1,0000	0,1337
0,0283	28,3168	28 316,8466	6,2288	7,4805	1,0000

TEMPERATURE

Water	Kelvin K	Celsius °C	Fahrenheit °F	$^{\circ}\text{F} = ^{\circ}\text{C} \times \frac{9}{5} + 32$ $^{\circ}\text{C} = (^{\circ}\text{F} - 32) \times \frac{5}{9}$
icing	273,1500	0,0000	32,0000	
boiling	373,1500	100,0000	212,0000	

G-at_pp-en_b_sc

**FURTHER PRODUCT SELECTION
AND DOCUMENTATION**
Xylect



Xylect is pump solution selection software with an extensive online database of product information across the entire Lowara range of pumps and related products, with multiple search options and helpful project management facilities. The system holds up-to-date product information on thousands of products and accessories.

The possibility to search by applications and the detailed information output given makes it easy to make the optimal selection without having detailed knowledge about the Lowara products.

The search can be made by:

- Application
- Product type
- Duty point

Xylect gives a detailed output:

- List with search results
- Performance curves (flow, head, power, efficiency, NPSH)
- Motor data
- Dimensional drawings
- Options
- Data sheet printouts
- Document downloads included dxf files

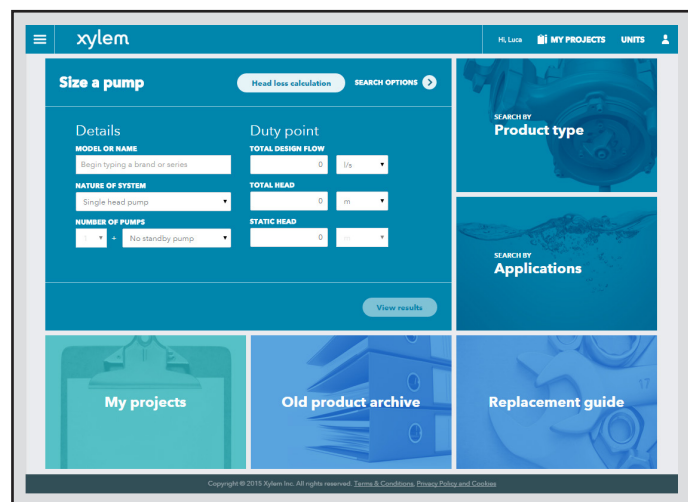

The search by application guides users not familiar with the product range to the right choice.

FURTHER PRODUCT SELECTION AND DOCUMENTATION

Xylect



The detailed output makes it easy to select the optimal pump from the given alternatives.

The best way to work with Xylect is to create a personal account. This makes it possible to:

- Set own standard units
- Create and save projects
- Share projects with other Xylect users

Every registered user has a proper space, where all projects are saved.

For more information about Xylect please contact our sales network or visit www.xylect.com.

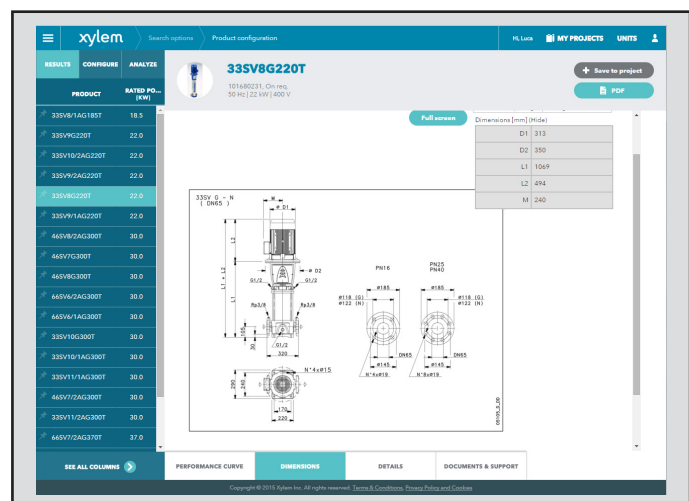

Dimensional drawings appear on the screen and can be downloaded in dxf format.

Xylem |'zīləm|

- 1) The tissue in plants that brings water upward from the roots;
- 2) a leading global water technology company.

We're a global team unified in a common purpose: creating advanced technology solutions to the world's water challenges. Developing new technologies that will improve the way water is used, conserved, and re-used in the future is central to our work. Our products and services move, treat, analyze, monitor and return water to the environment, in public utility, industrial, residential and commercial building services settings. Xylem also provides a leading portfolio of smart metering, network technologies and advanced analytics solutions for water, electric and gas utilities. In more than 150 countries, we have strong, long-standing relationships with customers who know us for our powerful combination of leading product brands and applications expertise with a strong focus on developing comprehensive, sustainable solutions.

For more information on how Xylem can help you, go to www.xylem.com



Hauptsitz

Gloor Pumpenbau AG
Thunstrasse 25
CH-3113 Rubigen
Tel. +41 (0)58 255 43 34
info@gloor-pumpen.ch
www.gloor-pumpen.ch

Filiale Mittelland

Gloor Pumpenbau AG
Industriestrasse 25
CH-5036 Oberentfelden



Filiale Suisse Romande

Gloor Pumpenbau SA
Rue du Collège 3 | Case postale
CH-1410 Thierrens
Tél. +41 (0)58 255 43 34
info@gloor-pompes.ch
www.gloor-pompes.ch